

# EPSON

ROBOT CONTROLLER / Drive Unit

*RC700DU /*

*RC700DU-A*

Rev.11

EM208C4461F

ROBOT CONTROLLER / Drive Unit      RC700DU / RC700DU-A    Rev.11

ROBOT CONTROLLER / DRIVE UNIT

# *RC700DU / RC700DU-A*

Rev.11

Copyright © 2014-2020 SEIKO EPSON CORPORATION. All rights reserved.

# FOREWORD

Thank you for purchasing our robot products.

This manual contains the information necessary for the correct use of the Robot Controller and the Drive Unit.

Please carefully read this manual and other related manuals before installing the robot system.

Keep this manual handy for easy access at all times.

RC700 / RC700-A robot Controller consists of the following:

RC700 CU / RC700CU-A (Control Unit)

RC700 DU / RC700DU-A (Drive Unit)

This manual contains the information for the RC700 DU / RC700DU-A (Drive Unit).

For RC700 CU / RC700CU-A (Control Unit), refer to the *RC700 / RC700-A Robot Controller* manual.

The information for the Robot Controller is describes as below, indicating both RC700 CU / RC700CU-A and RC700 DU / RC700DU-A:

Robot Controller

Controller

RC700

The information for the either unit (CU or DU) is described as below:

RC700CU / RC700CU-A Control Unit

RC700DU / RC700DU-A Drive Unit

# WARRANTY

The robot system and its optional parts are shipped to our customers only after being subjected to the strictest quality controls, tests, and inspections to certify its compliance with our high performance standards.

Product malfunctions resulting from normal handling or operation will be repaired free of charge during the normal warranty period. (Please contact the supplier of your region for warranty period information.)

However, customers will be charged for repairs in the following cases (even if they occur during the warranty period):

1. Damage or malfunction caused by improper use which is not described in the manual, or careless use.
2. Malfunctions caused by customers' unauthorized disassembly.
3. Damage due to improper adjustments or unauthorized repair attempts.
4. Damage caused by natural disasters such as earthquake, flood, etc.

Warnings, Cautions, Usage:

1. If the robot system associated equipment is used outside of the usage conditions and product specifications described in the manuals, this warranty is void.
2. If you do not follow the WARNINGS and CAUTIONS in this manual, we cannot be responsible for any malfunction or accident, even if the result is injury or death.
3. We cannot foresee all possible dangers and consequences. Therefore, this manual cannot warn the user of all possible hazards.

## TRADEMARKS

Microsoft, Windows, and Windows logo are either registered trademarks or trademarks of Microsoft Corporation in the United States and/or other countries. Other brand and product names are trademarks or registered trademarks of the respective holders.

## TRADEMARK NOTATION IN THIS MANUAL

Microsoft® Windows® 8 Operating system

Microsoft® Windows® 10 Operating system

Throughout this manual, Windows 8 and Windows 10 refer to above respective operating systems. In some cases, Windows refers generically to Windows 8 and Windows 10.

## NOTICE

No part of this manual may be copied or reproduced without authorization.

The contents of this manual are subject to change without notice.

Please notify us if you should find any errors in this manual or if you have any comments regarding its contents.

## MANUFACTURER

**SEIKO EPSON CORPORATION**

## CONTACT INFORMATION

Contact information is described in “SUPPLIERS” in the first pages of the following manual:

*Robot System Safety and Installation Read this manual first*

## Safety

<b>1. Safety</b>	<b>3</b>
<b>2. Conventions</b>	<b>3</b>
<b>3. Safety Precautions</b>	<b>4</b>

## Setup & Operation

<b>1. Specifications</b>	<b>9</b>
1.1 System Example .....	9
1.2 Drive Unit Standard Specifications .....	11
1.3 Outer Dimensions .....	12
<b>2. Part Names and Functions</b>	<b>13</b>
2.1 LED .....	15
2.2 Safety Features.....	16
<b>3. Installation</b>	<b>18</b>
3.1 Unpacking.....	18
3.2 Environmental Requirements .....	18
3.2.1 Environment .....	18
3.2.2 Installation .....	19
3.2.3 Wall Mounting Option.....	20
3.3 Power Supply .....	21
3.3.1 Specifications .....	21
3.3.2 AC Power Cable.....	22
3.4 Cable Connection .....	23
3.4.1 Typical Cable Connection .....	24
3.4.2 Connecting Manipulator to Drive Unit .....	26
3.5 Noise Countermeasures .....	27
<b>4. Drive Unit Connection</b>	<b>28</b>
<b>5. Drive Unit Setup</b>	<b>29</b>

<b>6. EMERGENCY</b>	<b>32</b>
6.1 Safety Door Switch and Latch Release Switch .....	32
6.1.1 Safety Door Switch .....	32
6.1.2 Latch Release Switch .....	33
6.1.3 Checking Latch Release Switch Operation .....	33
6.2 Emergency Stop Switch Connection .....	34
6.2.1 Emergency Stop Switch.....	34
6.2.2 Checking Emergency Stop Switch Operation .....	34
6.2.3 Recovery from Emergency Stop.....	34
6.3 Pin Assignments .....	35
6.4 Circuit and Wiring .....	36
6.4.1 Circuit Diagram .....	36
6.4.2 Wiring Example for Emergency Stop.....	37
6.4.3 Wiring Example for Safety Door Input / Latch Release Input.....	39
<b>7. I/O Connector</b>	<b>40</b>
7.1 Input Circuit.....	40
7.2 Output Circuit.....	43
7.3 Pin Assignments.....	45
<b>8. R-I/O Connector</b>	<b>46</b>
8.1 Input Circuit .....	46
8.2 Pin Assignments.....	47

## Maintenance

<b>1. Safety Precautions on Maintenance</b>	<b>51</b>
<b>2. Regular Maintenance Inspection</b>	<b>53</b>
<b>3. Drive Unit Structure</b>	<b>54</b>
3.1 Location of Parts.....	54
3.1.1 RC700DU.....	54
3.1.2 RC700DU-A .....	54
3.2 Diagram of Cable Connections .....	55
3.2.1 RC700DU.....	55
3.2.2 RC700DU-A .....	56



---

<b>4. Maintenance Parts Replacement Procedures</b>	<b>57</b>
4.1 Fan Filter .....	57
4.2 Fan .....	58
4.2.1 Front Fan .....	58
4.2.2 Fan 2 (RC700DU-A only) .....	59
4.3 MDB .....	61
4.4 DMB .....	65
4.5 DMB-SUB Board .....	67
4.6 DMB-LED Board .....	68
4.6.1 DMB-LED Board (RC700DU) .....	68
4.6.2 DMB-LED Board (RC700DU-A) .....	69
4.7 DPB .....	70
<b>5. Verifying Robot System Operation</b>	<b>72</b>
<b>6. Troubleshooting</b>	<b>73</b>
6.1 Error Code Table .....	73
<b>7. Maintenance Parts List</b>	<b>74</b>



# Safety

This section contains information for safety of the Robot System.





## 1. Safety

Installation and transportation of Manipulators and robotic equipment shall be performed by qualified personnel and should conform to all national and local codes.

Please read this manual and other related manuals before installing the robot system or before connecting cables. Keep this manual in a handy location for easy access at all times.

## 2. Conventions

Important safety considerations are indicated throughout the manual by the following symbols. Be sure to read the descriptions shown with each symbol.

 WARNING	This symbol indicates that a danger of possible serious injury or death exists if the associated instructions are not followed properly.
 WARNING	This symbol indicates that a danger of possible harm to people caused by electric shock exists if the associated instructions are not followed properly.
 CAUTION	This symbol indicates that a danger of possible harm to people or physical damage to equipment and facilities exists if the associated instructions are not followed properly.

### 3. Safety Precautions

Only trained personnel should design and install the robot system.

Trained personnel are defined as those who have taken robot system training class held by the manufacturer, dealer, or local representative company, or those who understand the manuals thoroughly and have the same knowledge and skill level as those who have completed the training courses.



The following items are safety precautions for qualified design or installation personnel:

 <p>WARNING</p>	<ul style="list-style-type: none"><li>■ Personnel who design and/or construct the robot system with this product must read the Safety chapter in User's Guide to understand the safety requirements before designing and/or constructing the robot system. Designing and/or constructing the robot system without understanding the safety requirements is extremely hazardous, may result in serious bodily injury and/or severe equipment damage to the robot system, and may cause serious safety problems.</li><li>■ The Manipulator and the Drive Unit must be used within the environmental conditions described in their respective manuals. This product has been designed and manufactured strictly for use in a normal indoor environment. Using the product in an environment that exceeds the specified environmental conditions may not only shorten the life cycle of the product but may also cause serious safety problems.</li><li>■ The robot system must be used within the installation requirements described in the manuals. Using the robot system outside of the installation requirements may not only shorten the life cycle of the product but also cause serious safety problems.</li><li>■ The interlock of the Safety Door must be functioning when the robot system is operated. Do not operate the system under the condition that the switch cannot be turned ON/OFF. (I.E. the condition where the switch is disabled) (Example: Tape is put around the switch to hold it closed.) Operating the robot system when the switch is not functioning properly is extremely hazardous and may cause serious safety problems as the Safety Door input cannot fulfill its intended function.</li><li>■ Connect input signal wires for Emergency Stop and Safety Door to the EMERGENCY connector so that the Emergency Stop switch in the whole system always functions. (Refer to the typical application diagram in <i>Setup &amp; Operation 6.4 Circuit and Wiring.</i>)</li></ul>
--	---

	<ul style="list-style-type: none"> <li>■ Do not open the cover(s) of the Drive Unit except while maintaining it. Opening the cover(s) of the Drive Unit is extremely hazardous and may result in electric shock even when its main power is OFF because of the high voltage charge inside the Drive Unit.</li> <li>■ Make sure that the power to the Drive Unit is turned OFF before connecting or disconnecting any cables. Connecting or disconnecting any cables with the power ON is extremely hazardous and may result in electric shock and/or malfunction of the Drive Unit.</li> <li>■ Be sure to connect the cables properly. Do not allow unnecessary strain on the cables. (Do not put heavy objects on the cables. Do not bend or pull the cables forcibly.) The unnecessary strain on the cables may result in damage to the cables, disconnection, and/or contact failure. Damaged cables, disconnection, or a contact failure is extremely hazardous and may result in electric shock and/or improper function of the system.</li> <li>■ When connecting the plug to fit the outlet in your factory, make sure that it is done by qualified personnel. When connecting the plug, be sure to connect the earth wire of the AC power cable colored green/yellow on the Drive Unit to the earth terminal of the factory power supply. The equipment must be grounded properly at all times to avoid the risk of electric shock. Always use a power plug and receptacle. Never connect the Drive Unit directly to the factory power supply. (Field wiring)</li> </ul>
---	--

	<ul style="list-style-type: none"> <li>■ The serial number of the Manipulator that should be connected is indicated on the Connection Check Label on the Drive Unit. Connect the Drive Unit and the Manipulator correctly. Improper connection between the Drive Unit and the Manipulator may cause improper function of the robot system and also safety problems.</li> <li>■ When using remote I/O, always make sure of the following. Using the robot system under unsatisfactory conditions may cause malfunction of the system and/or safety problems.             <ul style="list-style-type: none"> <li>- Assign remote functions to inputs/outputs correctly and wire correctly when setting up remote I/O signals.</li> <li>- Make sure that the functions correspond to the correct input/output signals before turning ON the system.</li> <li>- When verifying the robot system operation, prepare for failures with initial settings or wiring. If the Manipulator functions unusually by the failures with initial settings or wiring, press the Emergency Stop switch immediately to stop the Manipulator.</li> </ul> </li> </ul>
---	--

The following items are safety precautions for qualified operator personnel:

 <p>WARNING</p>	<ul style="list-style-type: none"><li>■ The interlock of the Safety Door must be functioning when the robot system is operated. Do not operate the system under the condition that the switch cannot be turned ON/OFF. (I.E. the condition where the switch is disabled) (Example: Tape is put around the switch to hold it closed.) Operating the robot system when the switch is not functioning properly is extremely hazardous and may cause serious safety problems as the Safety Door input cannot fulfill its intended function.</li></ul>
 <p>WARNING</p>	<ul style="list-style-type: none"><li>■ Do not open the cover(s) of the Drive Unit except while maintaining it. Opening the cover(s) of the Drive Unit is extremely hazardous and may result in electric shock even when its main power is OFF because of the high voltage charge inside the Drive Unit.</li></ul>



# Setup & Operation

This section contains information for setup and operation of the Drive Unit.



# 1. Specifications

## 1.1 System Example

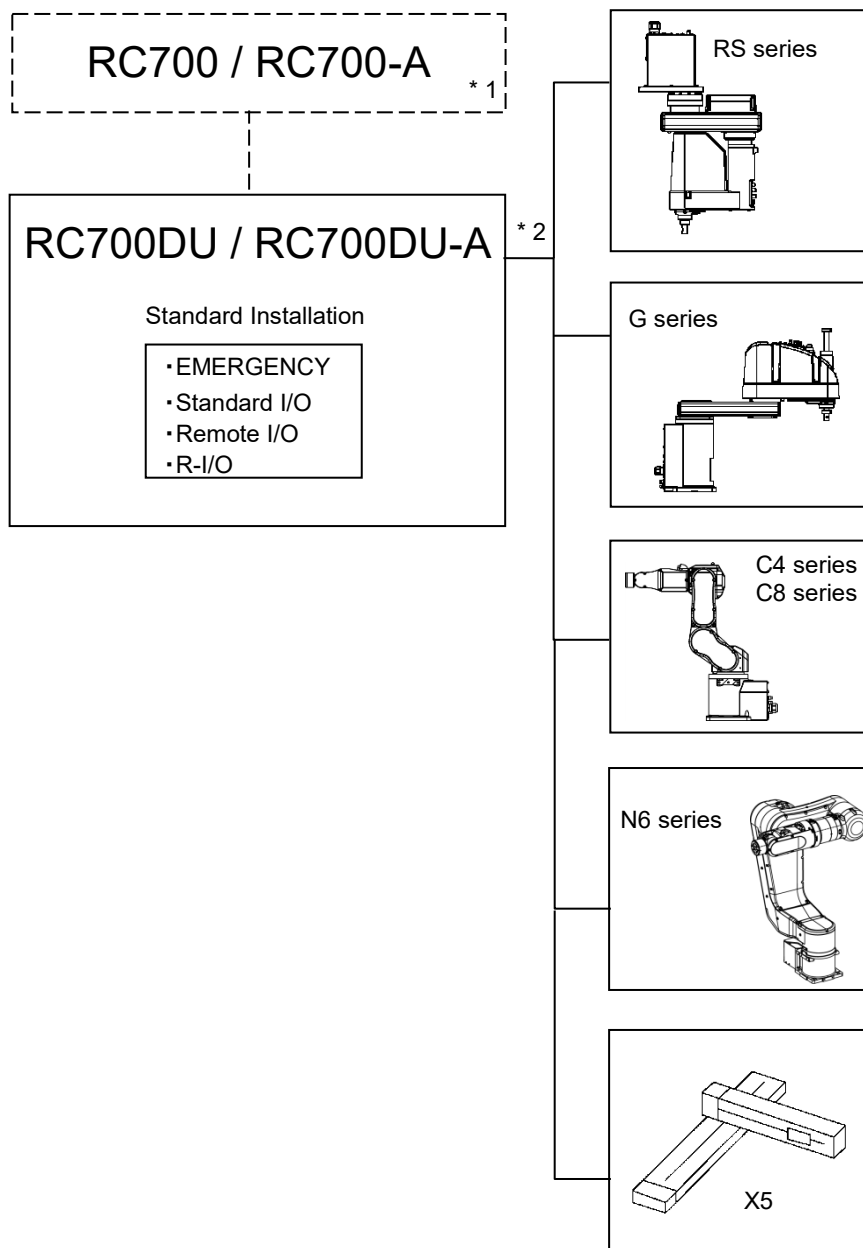

\*1 Control Unit

For details, refer to the following manual.

*Robot Controller RC700 / RC700-A*

\*2 Any one of the Manipulators can be controlled.

Available combinations are as follows. (✓: connectable)

	C4	C8	C12	G	RS	N2	N6	X5
RC700DU	✓	-	-	-	-	-	-	-
RC700DU-A	✓	✓	-	✓	✓	-	✓	✓

NOTE Drive Unit is the auxiliary unit connected with the control unit using the special cable.  
Drive Unit cannot operate alone.  
Up to three Drive Units can be used per robot system.

- A: Control Unit and 1<sup>st</sup> Drive Unit (CU-DU1)
- B: 1<sup>st</sup> Drive Unit and 2<sup>nd</sup> Drive Unit (DU1-DU2)
- C: 2<sup>nd</sup> Drive Unit and 3<sup>rd</sup> Drive Unit (DU2-DU3)

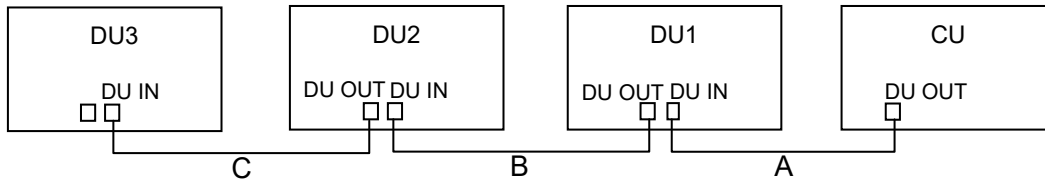

## 1.2 Drive Unit Standard Specifications

Item	Specification		
Model	Drive Unit RC700DU / RC700DU-A		
Controllable axes	Up to six (6) connectable AC servo motors		
External input/output signals (standard)	Standard I/O	Input : 24 Output : 16	per Drive Unit
Drive Unit connect interface (standard)	2 channel		
Safety features	<ul style="list-style-type: none"> <li>- Emergency stop switch</li> <li>- Safety door input</li> <li>- Low power mode</li> <li>- Dynamic brake</li> <li>- Motor overload detection</li> <li>- Irregular motor torque (out-of-control Manipulator) detection</li> <li>- Motor speed error detection</li> <li>- Positioning overflow - servo error - detection</li> <li>- Speed overflow - servo error - detection</li> <li>- CPU irregularity detection</li> <li>- Memory check-sum error detection</li> <li>- Overheat detection at the Motor Driver Module</li> <li>- Relay welding detection</li> <li>- Over-voltage detection</li> <li>- AC power supply voltage reduction detection</li> <li>- Temperature error detection</li> <li>- Fan error detection</li> </ul>		
Power Source	200 to 240 VAC Single phase 50/60 Hz		
Maximum Rated Capacity	2.5 kVA (Depending on the Manipulator model)		
Insulation Resistance	100 MΩ or more		
Rated Ambient Temperature	5 to 40 deg.		
Rated Relative Humidity	20 to 80% (with no condensation)		
Weight *1	9 kg		
Degree of protection	IP20		

\*1 Weight of the unit is indicated on the Drive Unit itself.

Make sure to check the weight before units transfer or relocation and prevent throwing out your back at holding the unit.

Also, make sure to keep your hands, fingers, and feet safe from being caught or serious injury.

### 1.3 Outer Dimensions

[Unit : mm]

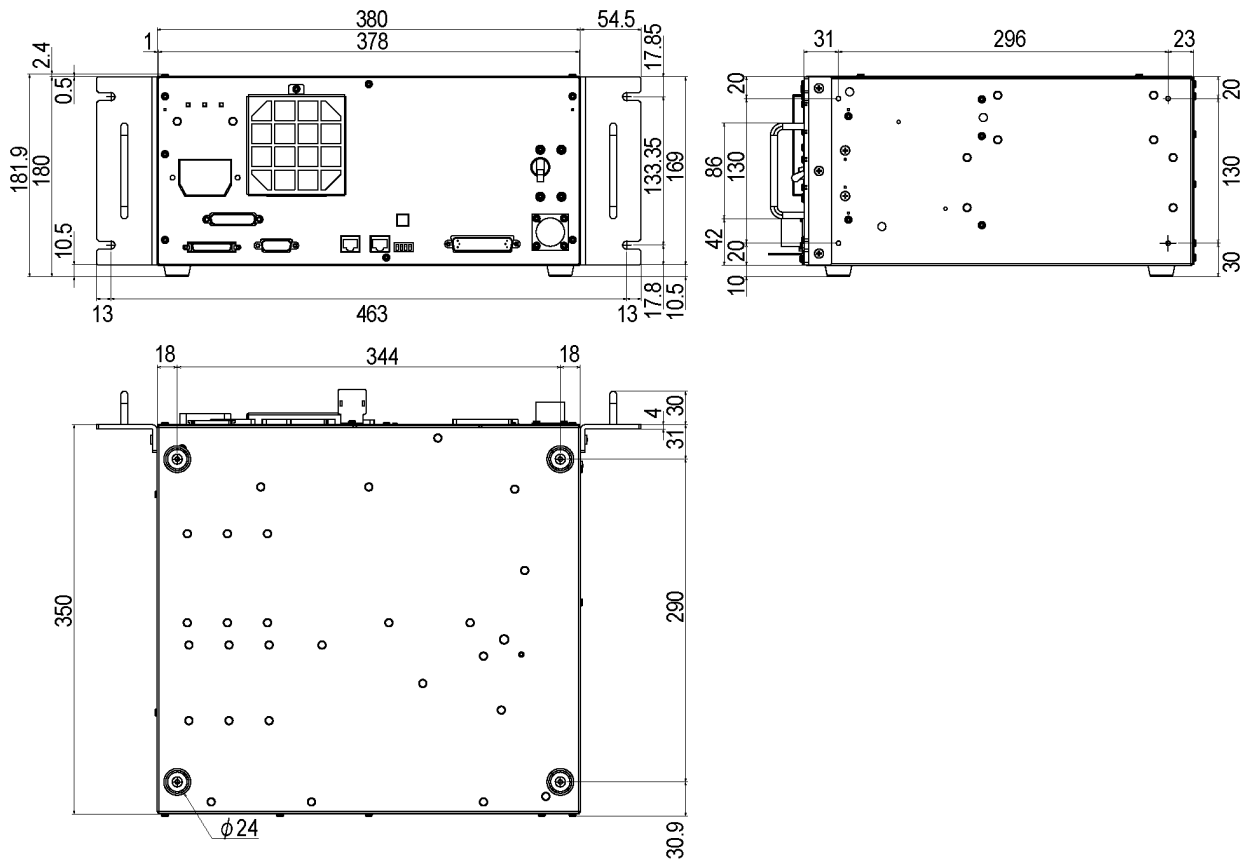

## 2. Part Names and Functions

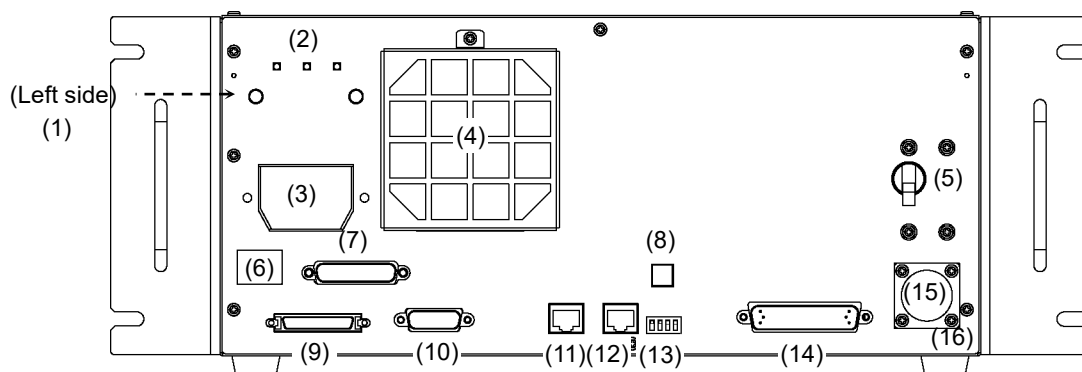

- (1) **Signature label (top panel)**  
The serial number of the Drive Unit and other information are shown.
- (2) **LED**  
The LED indicates current operation mode (RUN, AUTO, ERROR/E-STOP).  
For details, refer to *Setup & Operation 2.1 LED*.
- (3) **M/C POWER connector**  
A connector for the Manipulator power source.  
Connect the dedicated power cable attached to the Manipulator.
- (4) **Fan Filter**  
A protective filter is installed in front of the fan to filter out dust.  
Check the condition of the filter regularly and clean it when necessary. A dirty filter may result in malfunction of the robot system due to temperature rise of the Drive Unit.  
For inspection, cleaning, and replacement, refer to the *Maintenance 4.1 Fan Filter, 4.2 Fan*.
- (5) **POWER switch**  
Turns ON or OFF the Drive Unit.
- (6) **Connection Check label**  
The details of the Manipulator to be connected are recorded on the label as shown in the right. The label indicates the Manipulator model and Manipulator serial number.
- | MANIPULATOR |       |
|-------------|-------|
| C4-A600S    | 00001 |
- (7) **EMERGENCY connector**  
This connector is used for input/output from/to Emergency Stop and Safety Door switches. For details, refer to the *Setup & Operation 6. EMERGENCY*.

(8) Encoder Voltage Adjustment Switch

Use this switch to adjust voltage according to length of M/C cable. (adjusted as a factory default)

Wrong setting may result in Robot system malfunction. Do not change the switch.

Switch	M/C Cable Length
1	3 m
2	5 m
3	10 m
4	15, 20 m

(9) M/C SIGNAL connector

This connector is used for signals such as the Manipulator's motor encoders, etc. Connect the Manipulator's dedicated signal cable.

(10) R-I/O connector

This connector is for the input signals used for the real time I/O function.

(11) RC700DU: DU OUT Connector / RC700DU-A: OUT Connector

To connect the 2<sup>nd</sup> Drive Unit:

Use the cable attached for Drive Unit and connect with the DU IN connector of the 2<sup>nd</sup> Drive Unit.

To connect the 3<sup>rd</sup> Drive Unit:

Use the cable attached for Drive Unit and connect with the DU IN connector of the 3<sup>rd</sup> Drive Unit.

(12) RC700DU: DU IN Connector / RC700DU-A: IN Connector

For the 1<sup>st</sup> Drive Unit:

Use the cable attached for Drive Unit and connect with the DU OUT connector of the Control Unit.

For the 2<sup>nd</sup> Drive Unit:

Use the cable attached for Drive Unit and connect with the DU OUT connector of the 1<sup>st</sup> Control Unit.

For the 3<sup>rd</sup> Drive Unit:

Use the cable attached for Drive Unit and connect with the DU OUT connector of the 2<sup>nd</sup> Control Unit.

(13) RC700DU / RC700DU-A No. Setting Switch

This switch indicated the Drive Unit number.

For details, refer to the *Setup & Operation 5. Drive Unit Setup*.

(14) I/O connector

This connector is used for input/output device. There are 24 inputs and 16 outputs.

For details, refer to *Setup & Operation 7. I/O Connector*.

(15) AC IN

The cable for 200VAC power input.

For details, refer to *Setup & Operation 3.3.2 AC Power Cable*.

(16) Drive Unit Number label

The serial number of the Drive Unit is indicated.



## 2.1 LED

Three LEDs are mounted on Drive Unit. They have the following status patterns.

LED	Color	Status
RUN	Green	ON / Flashing / OFF
AUTO	Green	ON / OFF
ERR/E-STOP	Red	ON / Flashing / OFF

From applying current to Drive Unit to completing startup

	Drive Unit LED			DU IN connector
	RUN	AUTO	ERR/E-STOP	LINK (Green)
Power OFF	OFF	OFF	OFF	OFF
Power ON	Flashing	OFF	OFF	OFF
Establishing the connection	Flashing	OFF	OFF	Flashing rapidly
Normally operating	ON	OFF	OFF	Flashing rapidly

After the connection to Drive Unit is completed

LED	Status			
Auto mode	ON	ON	-	Flashing rapidly
Program mode	ON	OFF	-	Flashing rapidly
Teach mode	ON	OFF	-	Flashing rapidly
Robot error	ON	-	Flashing	Flashing rapidly
Emergency stop	ON	-	ON	Flashing rapidly

NOTE



The error information is displayed on the seven-segment display of the Control Unit.

For details, refer to the *RC700 / RC700-A Robot Controller manual: Setup & Operation 2.1 LED and Seven-segment LED*.

## 2.2 Safety Features

The robot control system supports safety features described below. However, the user is recommended to strictly follow the proper usage of the robot system by thoroughly reading the attached manuals before using the system. Failure to read and understand the proper usage of the safety functions is highly dangerous.

Among the following safety features, the Emergency Stop Switch and Safety Door Input are particularly important. Make sure that these and other features function properly before operating the robot system.

For details, refer to the *Setup & Operation 6. EMERGENCY*.

### Emergency Stop Switch

The EMERGENCY connector on the Drive Unit has expansion Emergency Stop input terminals used for connecting the Emergency Stop switches.

Pressing any Emergency Stop switch can shut off the motor power immediately and the robot system will enter the Emergency Stop condition.

Stop category of Emergency Stop input: Category 0 (refer to [Safety Standard IEC60204-1](#))

### Safety Door Input

In order to activate this feature, make sure that the Safety Door Input switch is connected to the EMERGENCY connector at the Drive Unit.

When the safety door is opened, normally the Manipulator immediately stops the current operation, and the status of Manipulator power is operation-prohibited until the safety door is closed and the latched condition is released. In order to execute the Manipulator operation while the safety door is open, you must change the mode selector key switch on the Teach Pendant to the “Teach” mode. Manipulator operation is available only when the enable switch is on. In this case, the Manipulator is operated in low power status.

Stop category of Safety door input: Category 1 (refer to [Safety Standard IEC60204-1](#))

### Low Power Mode

The motor power is reduced in this mode.

Executing a power status change instruction will change to the restricted (low power) status regardless of conditions of the safety door or operation mode. The restricted (low power) status ensures the safety of the operator and reduces the possibility of peripheral equipment destruction or damage caused by careless operation.

### Dynamic Brake

The dynamic brake circuit includes relays that short the motor armatures. The dynamic brake circuit is activated when there is an Emergency Stop input or when any of the following errors is detected: encoder cable disconnection, motor overload, irregular motor torque, motor speed error, servo error (positioning or speed overflow), irregular CPU, memory check-sum error and overheat condition inside the Motor Driver Module.

### Motor Overload Detection

The dynamic brake circuit is activated when the system detects the overload status of the motor.

### Irregular Motor Torque (out-of-control Manipulator) Detection

The dynamic brake circuit is activated when irregular motor torque (motor output) is detected.

#### Motor Speed Error Detection

The dynamic brake circuit is activated when the system detects that the motor is running at incorrect speed.

#### Positioning Overflow –Servo Error- Detection

The dynamic brake circuit is activated when the system detects that the difference between the Manipulator's actual position and commanded position exceeds the margin of error allowed.

#### Speed Overflow –Servo Error- Detection

The dynamic brake circuit is activated when the Manipulator's actual speed is detected to mark an overflow (the actual speed is outside the nominal range) error.

#### CPU Irregularity Detection

Irregularity of CPU that controls the motor is detected by the watchdog timer. The system CPU and the motor controlling CPU inside the Drive Unit are also designed to constantly check each other for any discrepancies. If a discrepancy is detected, the dynamic brake circuit is activated.

#### Memory Check-sum Error Detection

The dynamic brake circuit is activated when a memory check-sum error is detected.

#### Overheat Detection at the Motor Driver Module

The dynamic brake circuit is activated when the temperature of the power device inside the Motor Driver module is above the nominal limit.

#### Relay Deposition Detection

The dynamic brake circuit is activated when relay deposition, junction error, or open fault is detected.

#### Over-Voltage Detection

The dynamic brake circuit is activated when the voltage of the Drive Unit is above the normal limit.

#### AC Power Supply Voltage Drop Detection

The dynamic brake circuit is activated when the drop of the power supply voltage is detected.

#### Temperature Anomaly Detection

The temperature anomaly is detected.

#### Fan Malfunction Detection

Malfunction of the fan rotation speed is detected.

## 3. Installation

### 3.1 Unpacking

I/O Connector	1 set
Rack-Mount Plate	1 set
Power Cable	1 cable
EMERGENCY port connector	1 set
Connecting cable for RC700DU	1 cable

### 3.2 Environmental Requirements



- The Manipulator and the Drive Unit must be used within the environmental conditions described in their manuals. This product has been designed and manufactured strictly for use in a normal indoor environment. Using the product in the environment that exceeds the conditions may not only shorten the life cycle of the product but also cause serious safety problems.

#### 3.2.1 Environment

In order to optimize the robot system's performance for safety, the Drive Unit must be placed in an environment that satisfies the following conditions:



- The Drive Unit is not designed for clean-room specification. If it must be installed in a clean room, be sure to install it in a proper enclosure with adequate ventilation and cooling.
- Install Drive Unit in a location that allows easy connection / disconnection of cables.

Item	Condition
Ambient temperature	5 to 40 deg. (with minimal variation)
Ambient relative humidity	20 to 80% (with no condensation)
Fast transient burst noise	2 kV or less (Power supply wire) 1 kV or less (Signal wire)
Electrostatic noise	4 kV or less
Base table	Use a base table that is at least 100 mm off the floor. Placing the Drive Unit directly on the floor could allow dust penetration leading to malfunction.

If the Drive Unit must be used in an environment that does not fulfill the conditions mentioned above, take adequate countermeasures. For example, the Drive Unit may be enclosed in a cabinet with adequate ventilation and cooling.

- Install indoors only.
- Place in a well-ventilated area.
- Keep away from direct sunlight and radiation heat.
- Keep away from dust, oily mist, oil, salinity, metal powder or other contaminants.
- Keep away from water.
- Keep away from shocks or vibrations.
- Keep away from sources of electronic noise
- Do not apply strong electric or magnetic field.

### 3.2.2 Installation

Install the Drive Unit on a flat surface such as wall, floor, and Controller box in the direction shown from (A) to (C).

(A) Flat Mounting

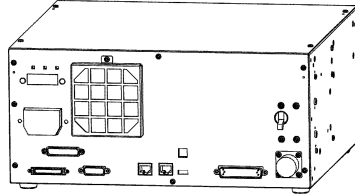

(B) Upright Mounting

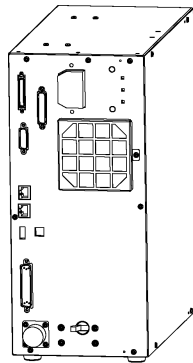

(C) Rack Mounting

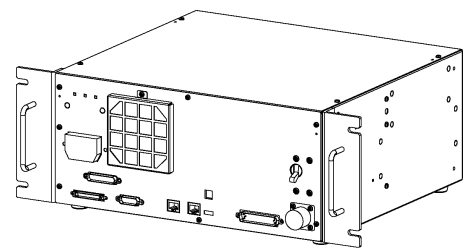

\* A plate for rack mounting is required.

\* The rubber foot needs to be replaced.

NOTE  

For Drive Unit installation to the Controller box or the base table, process screw holes as follows.

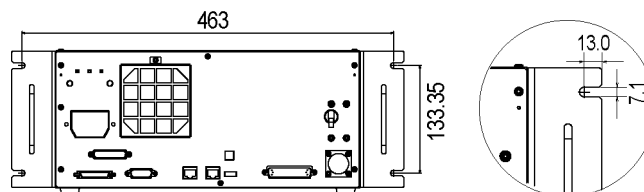

- Ensure the draft around the in/out and prevent the other equipment, walls and install the Drive Unit by keeping the distance as follows for maintenance.

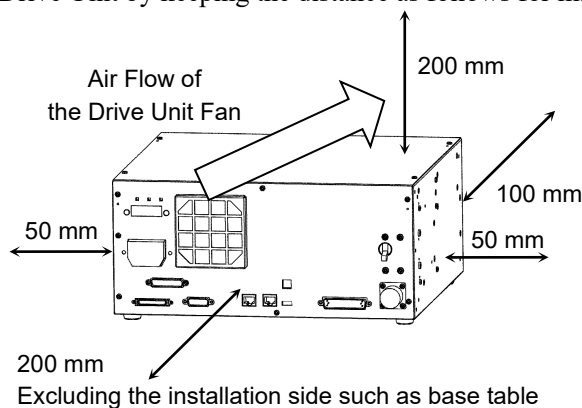

- Hot air with higher temperature than the ambient temperature (about 10 deg.C) comes out from the Drive Unit. Make sure that heat sensitive devices are not placed near the outlet.
- Arrange the cables in front of the Drive Unit so that you can pull the Drive Unit forward.

### 3.2.3 Wall Mounting Option

The Drive Unit has a wall mounting option.

Wall mounting with the front side down

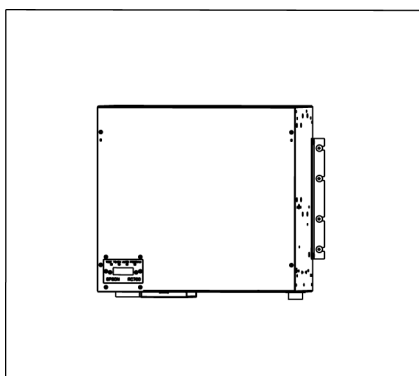

Wall mounting with the front side up

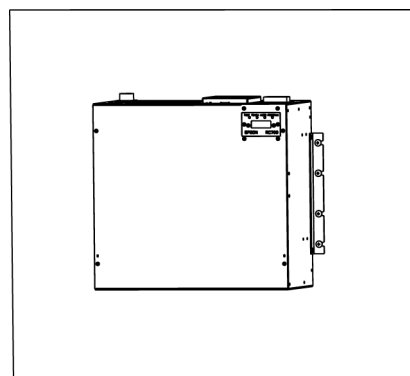

Included items of the wall mounting option

WALL FIXING BRACKET	2 brackets
LED DISPLAY FIXING PLATE	1 plate
LED DISPLAY PLATE	1 plate
Screw (M3 × 6 mm)	4 screws
Screw (M4 × 8 mm)	4 screws

Refer to one of the following for the Installation Procedure.

Installation Procedure sheet attached to the Wall Mounting option.

Manual: *ROBOT CONTROLLER RC700 / RC700-A*

*Setup & Operation 3.2.3 Wall Mounting Option*

### 3.3 Power Supply

#### 3.3.1 Specifications

Ensure that the available power meets following specifications.

Item	Specification
Voltage	200 to 240 VAC (Input voltage should be within $\pm 10\%$ of the rated voltage.)
Phase	Single phase
Frequency	50/60 Hz
Momentary Power Interrupt	10 msec. or less
Rated Capacity	<p>Maximum : 2.5 kVA            Actual power consumption depends on the model, motion, and load of the Manipulator.            For approximate power consumption of each model, refer to the followings.</p> <p>C4 : 1.7 kVA            C8 : 2.5 kVA            N6 : 2.2 kVA            G1 : 0.5 kVA            G3 : 1.1 kVA            G6 : 1.5 kVA            G10 : 2.4 kVA            G20 : 2.4 kVA            RS3 : 1.2 kVA            RS4 : 1.4 kVA</p> <p>Refer to the Manipulator manual for Manipulator rated capacity.            Rated capacity of X5 varies depending on the Manipulator model. For details, please contact the supplier of your region.</p>
Peak Current	<p>When power is turned ON : approximately 85 A (2 ms.)            When motor is ON : approximately 75 A (2 ms.)</p>
Leakage Current	Max. 10 mA
Ground Resistance	100 $\Omega$ or less

Install an earth leakage circuit breaker or a circuit breaker in the AC power cable line at 15 A or less rated electric current. Both should be a two-pole disconnect type. If you install an earth leakage circuit breaker, make sure to use an inverter type that does not operate by induction of a 10 kHz or more leakage current. If you install a circuit breaker, please select one that will handle the above mentioned "peak current".

The power receptacle shall be installed near the equipment and shall be easily accessible.

3.3.2 AC Power Cable



	<ul style="list-style-type: none"> <li>■ Make sure that operations are done by a qualified personal.</li> <li>■ Be sure to connect the earth wire (green/yellow) of the AC power cable to the earth terminal of the factory power supply. The equipment must be grounded properly at all times to avoid the risk of electric shock.</li> <li>■ Always use a power plug or a disconnecting device for power connecting cable. Never connect the Drive Unit directly to the factory power supply.</li> <li>■ Select the plug or a disconnecting device which conform safety standards for nations.</li> </ul>
---	---

Make sure to insert the plug of the AC power cable firmly when connecting to the Drive Unit.

Item	Specification
AC power wire (2 cables)	Black, Black or Black, White
Ground wire	Green / Yellow
Cable length	3 m
Terminal	M4 round solderless terminal



### 3.4 Cable Connection

 <p>WARNING</p>	<ul style="list-style-type: none"><li>■ Make sure that the power to the Drive Unit is turned OFF and the power plug is disconnected before connecting or disconnecting any cables. Connecting or disconnecting any cables with the power ON is extremely hazardous and may result in electric shock and malfunction of the Drive Unit.</li><li>■ Be sure to connect the cables properly. Do not allow unnecessary strain on the cables. (Do not put heavy objects on the cables. Do not bend or pull the cables forcibly.) The unnecessary strain on the cables may result in damage to the cables, disconnection, and/or contact failure. Damaged cables, disconnection, or contact failure is extremely hazardous and may result in electric shock and/or improper function of the system.</li></ul>
 <p>CAUTION</p>	<ul style="list-style-type: none"><li>■ The serial number of the Manipulator that should be connected is indicated on the Connection Check Label on the Drive Unit. Connect the Drive Unit and the Manipulator correctly. Improper connection between the Drive Unit and the Manipulator may cause not only improper function of the robot system but also safety problems.</li><li>■ Before connecting the connector, make sure that the pins are not bent. Connecting with the pins bent may damage the connector and result in malfunction of the robot system.</li></ul>

### 3.4.1 Typical Cable Connection

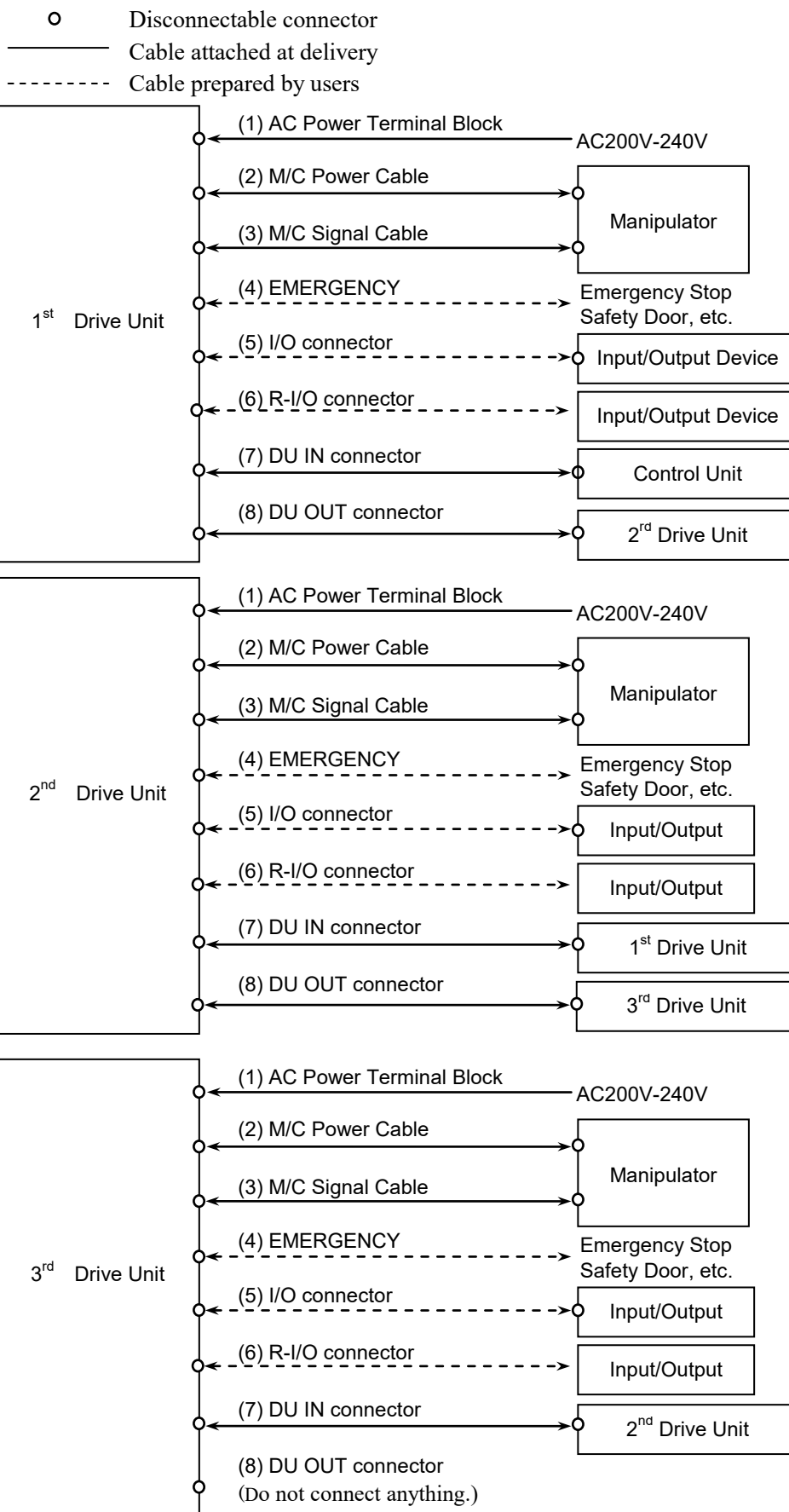

- (1) **AC Power terminal block**  
Terminal block for 200VAC power input to the Drive Unit.
- (2) **M/C Power cable**  
The cable with 50-pin connector on the Drive Unit side.  
Connect the POWER connector on the Manipulator and the M/C POWER connector on the Drive Unit. Insert the connectors until you hear a “click”.
- (3) **M/C Signal cable**  
The cable with 50-pin connector on the Drive Unit side.  
Connect the signal cable to the SIGNAL connector on the Manipulator and the M/C SIGNAL connector on the Drive Unit.
- (4) **EMERGENCY**  
The EMERGENCY connector has inputs to connect the Emergency Stop switch and the Safety Door switch. For safety reasons, connect proper switches for these input devices.  
For details, refer to the *Setup & Operation 6. EMERGENCY*.
- (5) **I/O connector**  
This connector is used for input/output devices of the user.  
When there are input/output devices, use this connector.  
There are I/O cable (option) and terminal block (option) for the I/O connector.  
For details, refer to the *Setup & Operation 7. I/O Connector*.
- (6) **R-I/O Connector**  
This connector is used for connecting with input signals necessary for real time I/O function.  
For details, refer to the *Setup & Operation 13. R-I/O Connector*.
- (7) **DU IN connector**  
For the 1<sup>st</sup> Drive Unit:  
Use the cable attached for Drive Unit and connect with the DU OUT connector of the Control Unit.  
For the 2<sup>nd</sup> Drive Unit:  
Use the cable attached for Drive Unit and connect with the DU OUT connector of the 1<sup>st</sup> Control Unit.  
For the 3<sup>rd</sup> Drive Unit:  
Use the cable attached for Drive Unit and connect with the DU OUT connector of the 2<sup>nd</sup> Control Unit.
- (8) **DU OUT connector**  
To connect the 2<sup>nd</sup> Drive Unit:  
Use the cable attached for Drive Unit and connect with the DU IN connector of the 2<sup>nd</sup> Drive Unit.  
To connect the 3<sup>rd</sup> Drive Unit:  
Use the cable attached for Drive Unit and connect with the DU IN connector of the 3<sup>rd</sup> Drive Unit.  
\* Be sure not to connect anything to this connector when using only one Drive Unit. Also, when using the 3<sup>rd</sup> Drive Unit, do not connect anything to this connector on the 2<sup>nd</sup> Drive Unit.

### 3.4.2 Connecting Manipulator to Drive Unit

Connect the Manipulator to the Drive Unit by using the Power cable and the Signal cable.

 WARNING	<ul style="list-style-type: none"> <li>■ Make sure that the power to the Drive Unit is turned OFF before connecting or disconnecting any cables. Connecting or disconnecting any cables with the power ON is extremely hazardous and may result in electric shock and malfunction of the Drive Unit.</li> <li>■ Be sure to connect the cables properly. Do not allow unnecessary strain on the cables. (Do not put heavy objects on the cables. Do not bend or pull the cables forcibly.) The unnecessary strain on the cables may result in damage to the cables, disconnection, and/or contact failure. Damaged cables, disconnection, or contact failure is extremely hazardous and may result in electric shock and/or improper function of the system.</li> </ul>
--	--

 CAUTION	<ul style="list-style-type: none"> <li>■ The serial number of the Manipulator that should be connected is indicated on the Drive Unit. Connect the Drive Unit and the Manipulator correctly. Improper connection between the Drive Unit and the Manipulator may cause not only improper function of the robot system but also serious safety problems.</li> </ul>
--	---

The configuration data for the Manipulator and Manipulator model are stored in the Drive Unit. Therefore the Drive Unit should be connected to the Manipulator whose serial number is specified in the Connection Check label attached on the front of the Drive Unit.



The Manipulator's serial number is indicated on the signature label on the back of the Manipulator.

### 3.5 Noise Countermeasures

To minimize electrical noise conditions, the following items must be observed in the system's cable wiring:

To minimize electrical noise condition, be sure of followings for wiring.

- The earth wire of the power supply should be grounded. (Ground resistance: 100  $\Omega$  or less) It is important to ground the frame of Drive Unit not only for prevention from electric shock, but also for reducing the influence of electric noise around the Drive Unit. Therefore, be sure to connect the earth wire (yellow/green) of the Drive Unit's power cable to the ground terminal of the factory power supply. For details about the plug and AC power cable, refer to the *Setup & Operation 3.3 Power Supply*.
- Do not tap power from a power line that connects to any equipment which may cause noise.
- When you tap power for the Drive Unit and the single-phase AC motor from the same power line, change the phase of one or the other. Ensure that they will not be the same phase.
- Use a twisted pair motor power line.
- Do not run AC power lines and DC power lines in the same wiring duct, and separate them as far as possible. For example, separate the AC motor power line and the Drive Unit power line as far as possible from the sensor or valve I/O lines; and do not bundle both sets of wiring with the same cable tie. If more than one duct/cable must cross each other, they should cross perpendicularly. The preferable example is shown in the right figure.

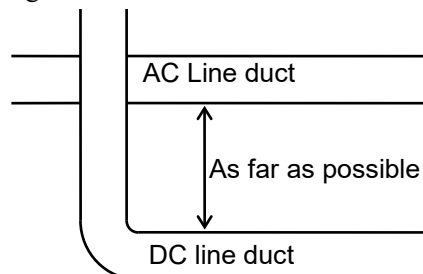

- Wire as short as possible to the I/O connector and EMERGENCY connector. Use a shielded cable and clamp the shield to the attached connector interior. Make sure to keep away from the peripheral noise source as far as possible.
- Make sure that the induction elements used to connect to the Drive Unit's I/O (such as relays and solenoid valves) have surge suppressors. If an induction element without a surge suppressor is used, make sure to connect a rectifying diode located at the induction element in parallel with it. In selecting a rectifying diode, make sure that it can handle the voltage and current incurred by the induction load.
- To start and change revolutions of the conveyer's (or the like's) AC motor (ex: an induction motor or three-phase induction motor) regularly or abruptly, make sure to install a spark suppressor between the wires. The spark suppressor is more effective when placed closer to the motor.
- As they are easily influenced by noise, keep cable such as USB, Ethernet, RS-232C, or fieldbus away from peripheral noise sources.

# 4. Drive Unit Connection

Drive Unit is connected to the Control Unit using the attached connection cable.

Up to three Drive Units can be connected to the Control Unit.

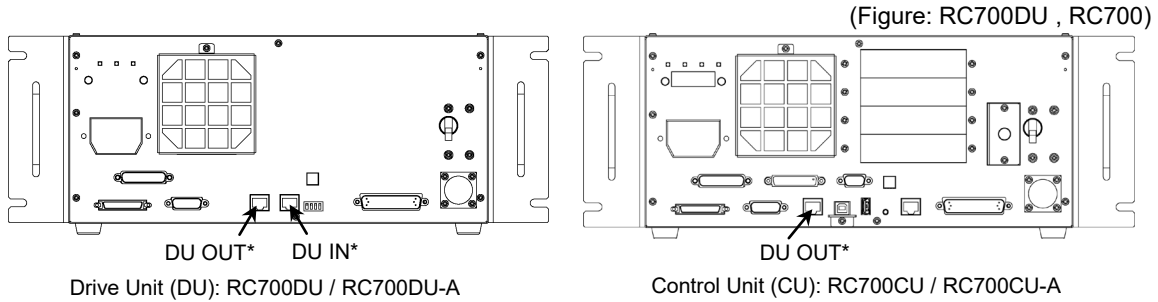

\* Name: RC700-A, RC700DU-A: OUT, IN

- A: Control Unit and 1<sup>st</sup> Drive Unit (CU-DU1)
- B: 1<sup>st</sup> Drive Unit and 2<sup>nd</sup> Drive Unit (DU1-DU2)
- C: 2<sup>nd</sup> Drive Unit and 3<sup>rd</sup> Drive Unit (DU2-DU3)

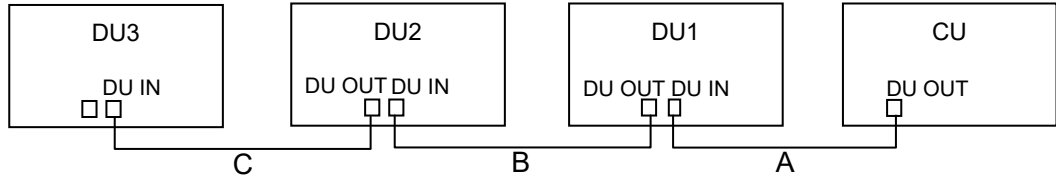

When you use one Drive Unit:  
Connect nothing to DU OUT of the 1<sup>st</sup> Drive Unit (DU1). Otherwise, it results in the Robot Controller malfunction.

When you use two Drive Units:  
Connect nothing to DU OUT of the 2<sup>nd</sup> Drive Unit (DU2). Otherwise, it results in the Robot Controller malfunction.

When you use three Drive Units:  
Connect nothing to DU OUT of the 3<sup>rd</sup> Drive Unit (DU3). Otherwise, it results in the Robot Controller malfunction.

When connecting the connection cable, make sure to connect to DU IN and DU OUT properly. Improper connection may cause malfunction.



Do not use any LAN cables on the market. Otherwise, it results in the Robot Controller malfunction.

How to turn on the power switch:  
Check the connection first. Then, make sure to turn on the power switch of Drive Unit before turning on the power switch of Control Unit.

## 5. Drive Unit Setup

The DIP switch is equipped on the front side to configure 1<sup>st</sup>, 2<sup>nd</sup>, and 3<sup>rd</sup> Drive Unit. Follow the steps below to set up the Drive Unit.

- (1) Turn OFF the Drive Unit.
- (2) Change the DIP switch.

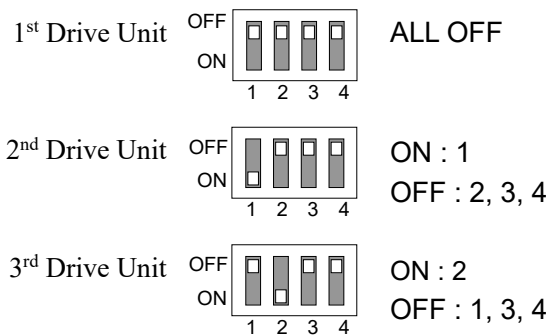
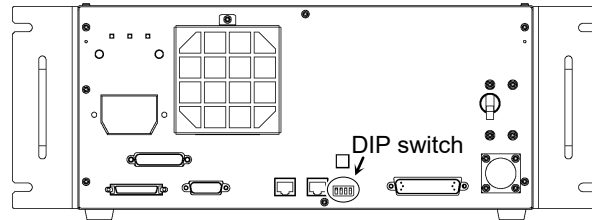

- (3) Attach the DU number label on Drive Unit.

DU1 : 1<sup>st</sup> Drive Unit  
 DU2 : 2<sup>nd</sup> Drive Unit  
 DU3 : 3<sup>rd</sup> Drive Unit

- (4) Plug in the power connector. Turn ON the Drive Unit.

Adding of information of the new system is required only for customers who purchased the Drive Unit singly.

Set up the Control Unit and Drive Unit and turn on the robot system. If information of the new system was not added, follow the steps below to add information.

- (1) Select the EPSON RC+ 7.0-[Setup]-[System Configuration].  
[System Configuration] dialog box will appear.

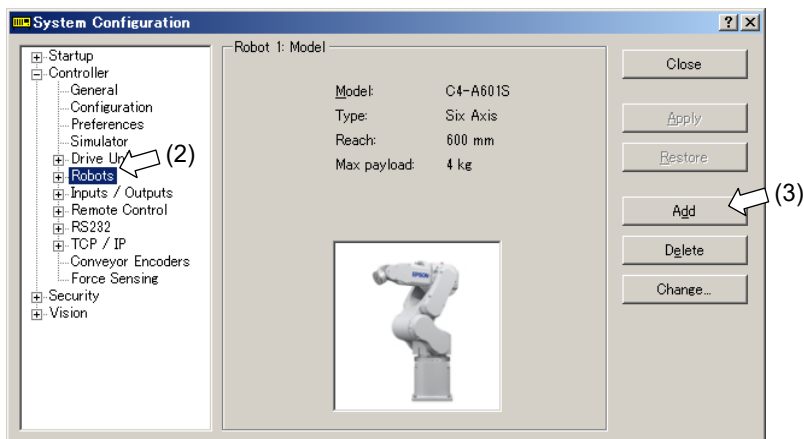

- (2) Click [Controller]-[Robots] in the tree on the left.

- (3) Click <Add> button.  
[Add New Robot] dialog box will appear.

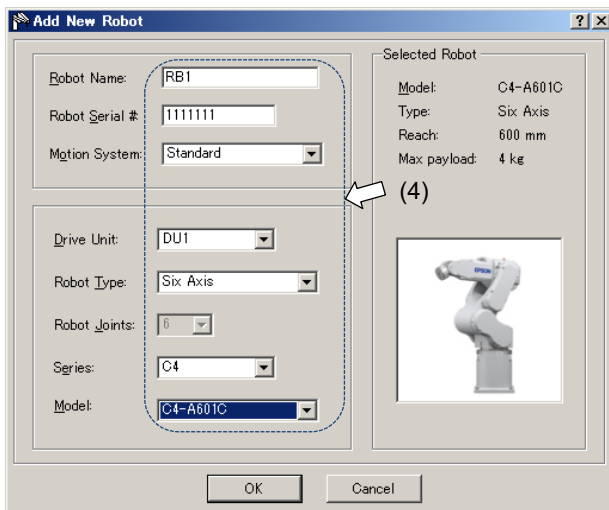



- (4) Enter the following items by referring to the *RC700DU Robot System Hofs Data Sheet* (hereinafter referred to as Hofs sheet) which is included with shipment.

Item	Description
Robot Name :	Type in a name for the new Manipulator. (Example: RB1 Robot1)
Robot Serial # :	Type in "Serial No." on the Hofs sheet. (or the serial number on the Manipulator's nameplate) Any serial number can be used, but it is recommended to use the number described above.
Motion System :	Select "Standard". If there are no other motion systems installed, "Standard" should be already selected.
Drive Unit :	Select a Drive Unit for your Manipulator. (DU1, DU2, DU3) DU numbers are configured by the dip switch on the front side and indicated by the indication labels.
Robot Type :	Select a Manipulator type.
Robot Joints :	This item cannot be changed.
Series :	Select a Manipulator series.
Model :	Select a Manipulator model. All Manipulators available for the motor driver currently installed in the Drive Unit will be displayed.

- (5) Click <OK> button. The EPSON RC+ will restart.
- (6) Click [Controller]-[Robots]-[Robot \*\*]-[Calibration] in the tree on the left. Following dialog box will appear.

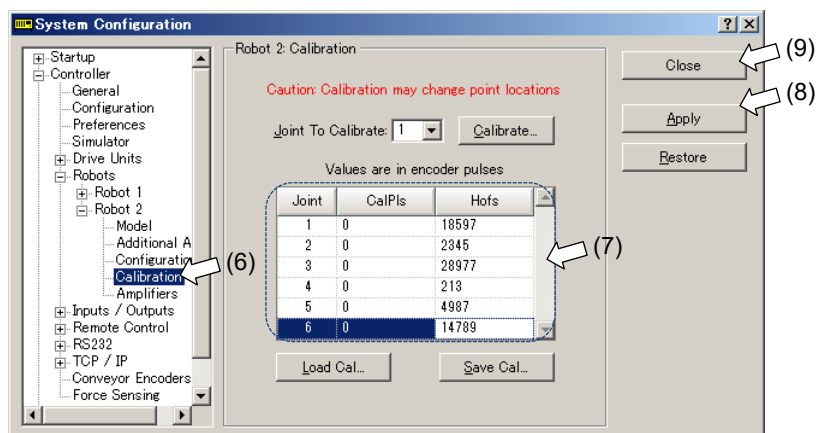

- (7) Type in the values on the Hofs sheet to [CalPIs] and [Hofs].
- (8) Click <Apply> button.
- (9) Click <Close> button.

# 6. EMERGENCY



The details of safety requirements for this section are described in *User's Guide 2. Safety*. Please refer to them to keep the robot system safe.



- Not only when turning on the device, but also changing use environment such as add options or replace parts for maintenance, make sure that the emergency stop or safety door work properly.

Connect a safeguard switch or Emergency Stop switch to the Drive Unit EMERGENCY connector for safety.

When nothing is connected to the EMERGENCY connector, the Drive Unit does not operate normally.



- Before connecting the connector, make sure that the pins are not bent. Connecting with the pins bent may damage the connector and result in malfunction of the robot system.

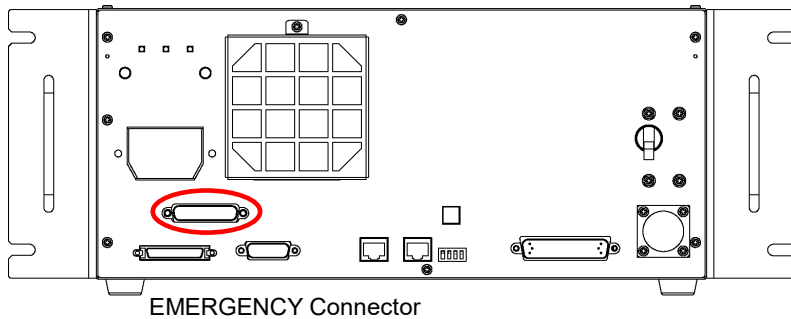

EMERGENCY Connector

## 6.1 Safety Door Switch and Latch Release Switch

The EMERGENCY connector has input terminals for the Safety Door switch and the Emergency Stop switch. Be sure to use these input terminals to keep the system safe.

Connector	Standard
EMERGENCY connector (Drive Unit side)	D-sub 25 male pin Mounting style #4 - 40

\* The connector cable, terminal block, and connector kit are offered as options.

### 6.1.1 Safety Door Switch



- The interlock of the Safety Door must be functioning when the robot system is operated. Do not operate the system under the condition that the switch cannot be turned ON/OFF (e.g. The tape is put around the switch.). Operating the robot system when the switch is not functioning properly is extremely hazardous and may cause serious safety problems as the Safety Door input cannot fulfill its intended function.

In order to maintain a safe working zone, a safeguard must be erected around the Manipulator. The safeguard must have an interlock switch at the entrance to the working zone. The Safety Door that is described in this manual is one of the safeguards and an interlock of the Safety Door is called a Safety Door switch. Connect the Safety Door switch to the Safety Door input terminal on the EMERGENCY connector.

The Safety Door switch has safety features such as temporary hold-up of the program or the operation-prohibited status that are activated whenever the Safety Door is opened.

Observe the followings in designing the Safety Door switch and the Safety Door.

- For the Safety Door switch, select a switch that opens as the Safety Door opens, and not by the spring of the switch itself.
- The signal from the Safety Door (Safety Door input) is designed to input to two redundant signals. If the signals at the two inputs differ by two seconds or more, the system recognizes it to be a critical error. Therefore, make sure that the Safety Door switch has two separate redundant circuits and that each connects to the specified pins at the EMERGENCY connector on the Drive Unit.
- The Safety Door must be designed and installed so that it does not close accidentally.

### 6.1.2 Latch Release Switch

The software latches these conditions:

- The safety door is open.
- The operation mode is set to “TEACH”.

The EMERGENCY connector has an input terminal for a latch release switch that cancels the latched conditions.

**Open** : The latch release switch latches conditions that the safety door is open or the operation mode is “TEACH”.

**Closed** : The latch release switch releases the latched conditions.

When the latched TEACH mode is released while the safety door is open, the status of Manipulator power is operation-prohibited because the safety door is open at that time.

To execute a Manipulator operation, close the safety door again, and then close the latch release input.



### 6.1.3 Checking Latch Release Switch Operation

After connecting the safety door switch and latch release switch to the EMERGENCY connector, be sure to check the switch operation for safety by following the procedures described below before operating the Manipulator.

- (1) Turn ON the Controller while the safety door is open in order to boot the software.
- (2) Make sure that “Safety” is displayed on the main window status bar.
- (3) Close the safety door, and turn ON the switch connecting to the latch release input. Make sure that the “Safety” is dimmed on the status bar.

The information that the safety door is open can be latched by software based on the latch release input condition.

**Open** : The latch release switch latches the condition that the safety door is open.

To cancel the condition, close the safety door, and then close the safety door latch release input.

**Closed** : The latch release switch does not latch the condition that the safety door is open.

The latch release input also functions to acknowledge the change of to TEACH mode.

In order to change the latched condition of TEACH mode, turn the mode selector key switch on the Teach Pendant to “Auto”. Then, close the latch release input.



## 6.2 Emergency Stop Switch Connection

### 6.2.1 Emergency Stop Switch

If it is desired to add an external Emergency Stop switch(es) in addition to the Emergency Stop on the Teach Pendant, be sure to connect such Emergency Stop switch(es) to the Emergency Stop input terminal on the EMERGENCY connector.

The Emergency Stop switch connected must comply with the related safety standards (such as IEC60947-5-5) and the following:

- It must be a push button switch that is “normally closed”.
- A button that does not automatically return or resume.
- The button must be mushroom-shaped and red.
- The button must have a double contact that is “normally closed”.



The signal from the Emergency Stop switch is designed to use two redundant circuits. If the signals at the two circuits differ by two seconds or more, the system recognizes it as a critical error. Therefore, make sure that the Emergency Stop switch has double contacts and that each circuit connects to the specified pins on the EMERGENCY connector at the Drive Unit. Refer to the *Setup & Operation 6.4 Circuit and Wiring*.

### 6.2.2 Checking Emergency Stop Switch Operation

Once the Emergency Stop switch is connected to the EMERGENCY connector, continue the following procedure to make sure that the switch functions properly. For the safety of the operator, the Manipulator must not be powered ON until the following test is completed.

- (1) Turn ON the Controller to boot the software while pressing the Emergency Stop switch.
- (2) Make sure that “ERROR/E-STOP” LED on Drive Unit has been turned ON.
- (3) Make sure that “E.Stop” is displayed on the status bar on the EPSON RC+ main window.
- (4) Release the Emergency Stop Switch.
- (5) Execute the RESET command.
- (6) Make sure that “ERROR/E-STOP” LED turns OFF and “E-Stop” display fades on the main window status bar.

### 6.2.3 Recovery from Emergency Stop

To recover from the emergency stop condition, follow the procedure of safety check as required by the system.

After safety check, the operations below are required to recover from the emergency stop condition.

- Release the Emergency Stop Switch
- Execute the RESET command

## 6.3 Pin Assignments

The EMERGENCY connector (D-sub25 male) pin assignments are as follows:

Pin No.	Signal	Function	Pin No.	Signal	Function
1	ESW11	Emergency Stop switch contact (1) *3	14	ESW21	Emergency Stop switch contact (2) *3
2	ESW12	Emergency Stop switch contact (1) *3	15	ESW22	Emergency Stop switch contact (2) *3
3	ESTOP1+	Emergency Stop circuit 1 (+) *4	16	ESTOP2+	Emergency Stop circuit 2 (+) *4
4	ESTOP1-	Emergency Stop circuit 1 (-) *4	17	ESTOP2-	Emergency Stop circuit 2 (-) *4
5	Not Used	*1	18	SDLATCH1	Safety Door Latch Release
6	Not Used	*1	19	SDLATCH2	Safety Door Latch Release
7	SD11	Safety Door input (1) *2	20	SD21	Safety Door input (2) *2
8	SD12	Safety Door input (1) *2	21	SD22	Safety Door input (2) *2
9	24V	+24V output	22	24V	+24V output
10	24V	+24V output	23	24V	+24V output
11	24VGND	+24V GND output	24	24VGND	+24V GND output
12	24VGND	+24V GND output	25	24VGND	+24V GND output
13	Not Used				

\*1 Do not connect anything to these pins.

\*2 A critical error occurs if the input values from the Safety Door 1 and Safety Door 2 are different for two or more seconds. They must be connected to the same switch with two sets of contacts.

\*3 A critical error occurs if the input values from the Emergency Stop switch contact 1 and Emergency Stop switch contact 2 are different for two or more seconds. They must be connected the same switch with two sets of contacts.

\*4 Do not apply reverse voltage to the Emergency Stop circuit.

Emergency Stop switch output rated load	+30 V 0.3 A or under	1-2, 14-15 pin
Emergency Stop rated input voltage range Emergency Stop rated input current	+24 V $\pm$ 10% 47.5 mA/+24 V input	3-4, 16-17 pin
Safety Door rated input voltage range Safety Door rated input current	+24 V $\pm$ 10% 10 mA/+24 V input	7-8, 20-21 pin
Latch Release rated input voltage range Latch Release rated input current	+24 V $\pm$ 10% 10 mA/+24 V input	18-19 pin

 NOTE The total electrical resistance of the Emergency Stop switches and their circuit should be 1  $\Omega$  or less.

 <b>CAUTION</b>	<ul style="list-style-type: none"> <li>■ The 24 V output is for emergency stop. Do not use it for other purposes. Doing so may result in system malfunction.</li> <li>■ The 24 V output is for emergency stop. Do not use it for other purposes. Doing so may result in system malfunction.</li> </ul>
---	--

## 6.4 Circuit and Wiring

### 6.4.1 Circuit Diagram

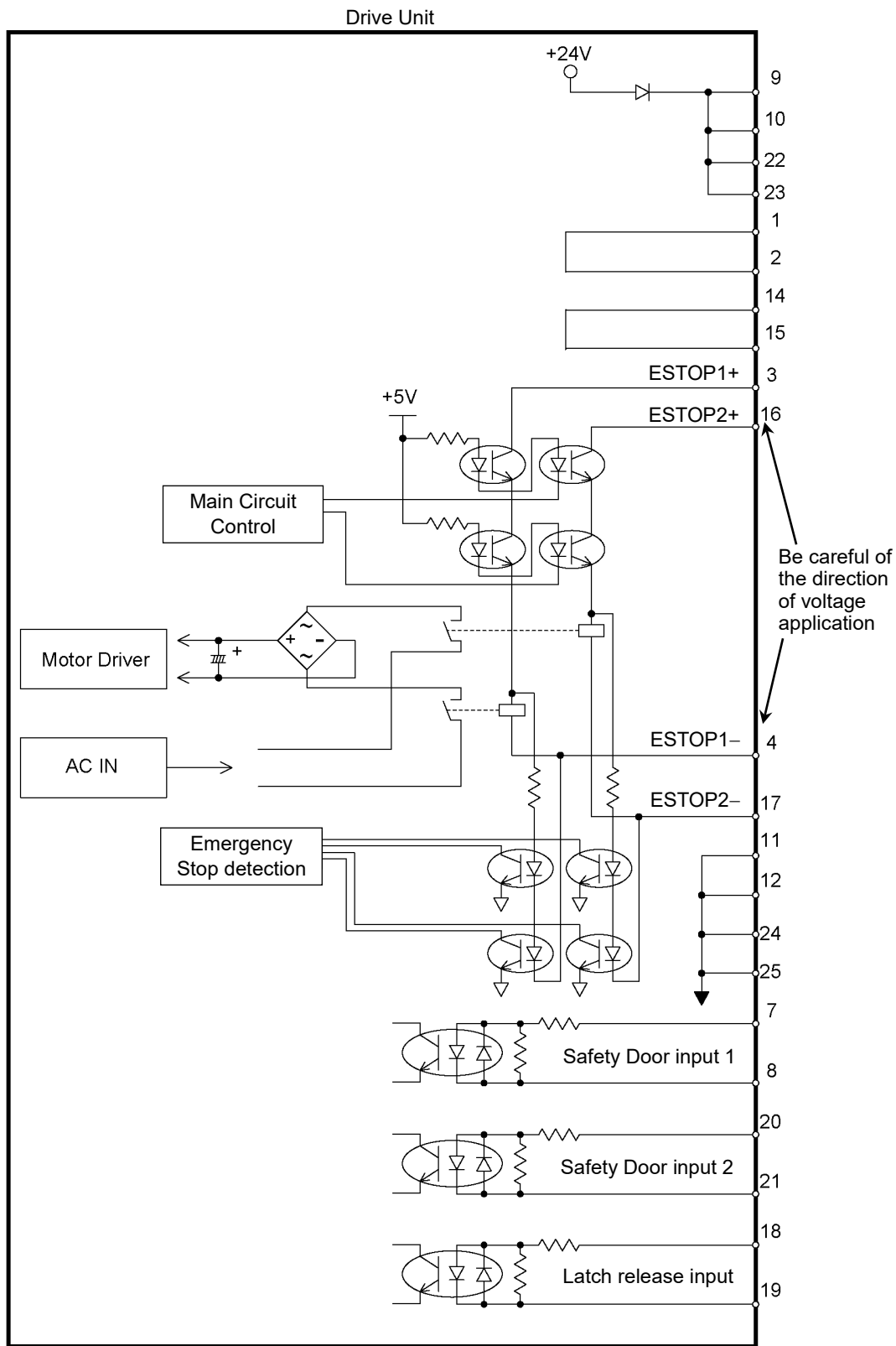

NOTE : +24V GND ▼  
 +5V GND ▽

6.4.2 Wiring Example for Emergency Stop

6.4.2.1 External emergency stop switch typical application

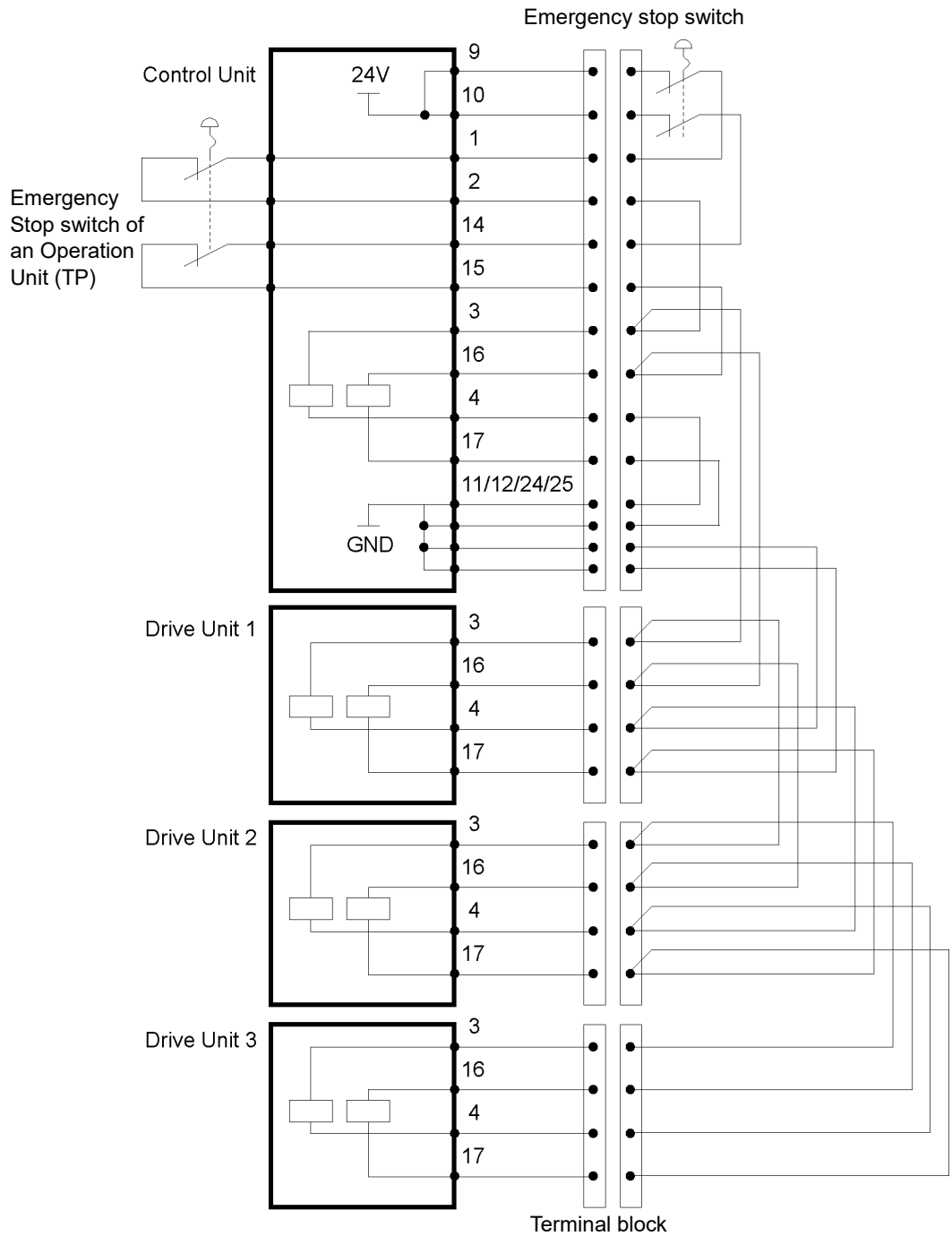

NOTE  

The Emergency cable, Emergency cable kit, and Terminal block are offered as options.

Design the cables connecting the units within 20 m long.

6.4.2.2 External safety relay typical application

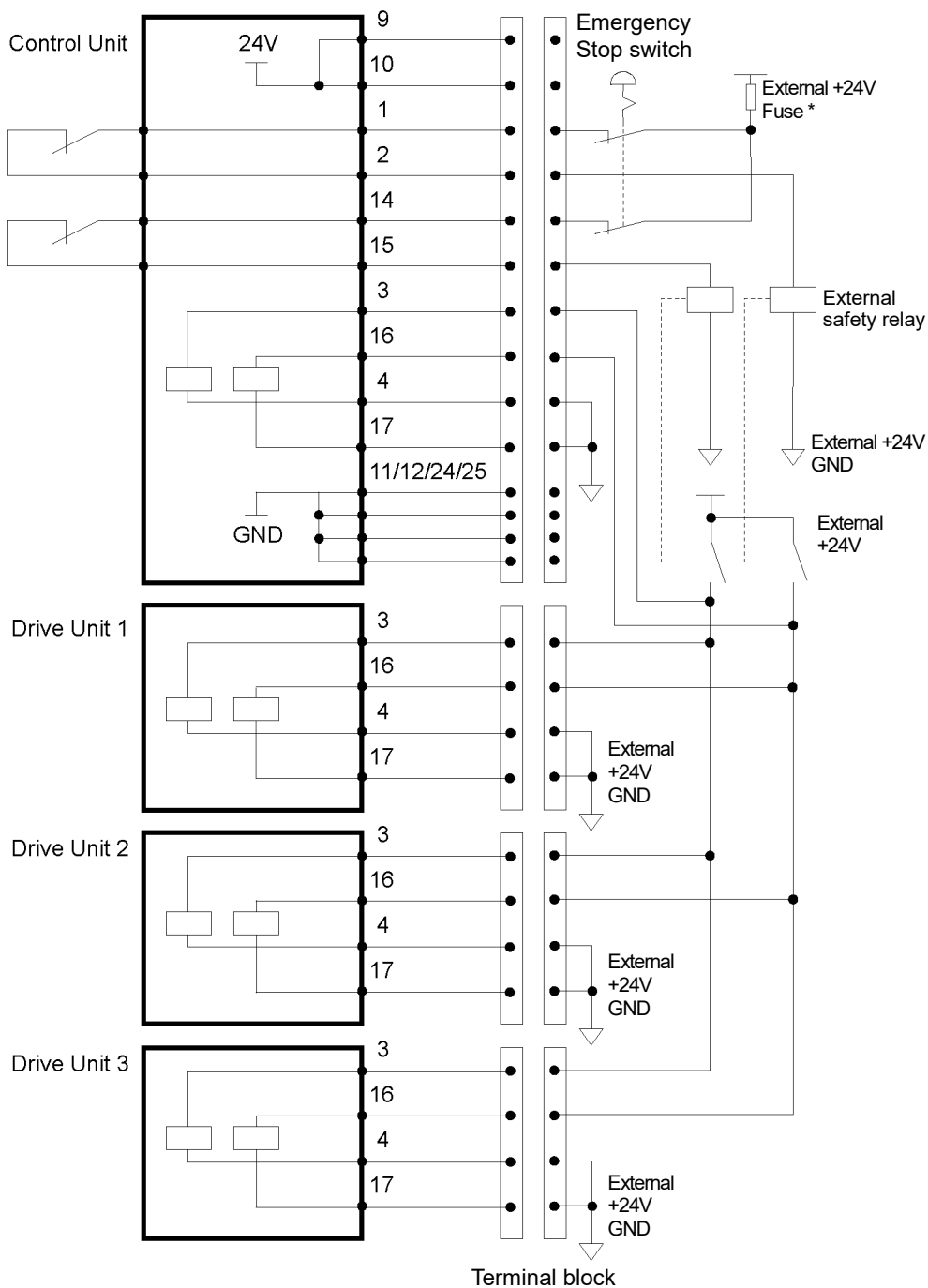

\* Fuse  
 For the protection of the emergency stop circuit, the fuse's capacity should be as follows:  
 - Meets the capacity of the external  
 - 0.4A or less



6.4.3 Wiring Example for Safety Door Input / Latch Release Input

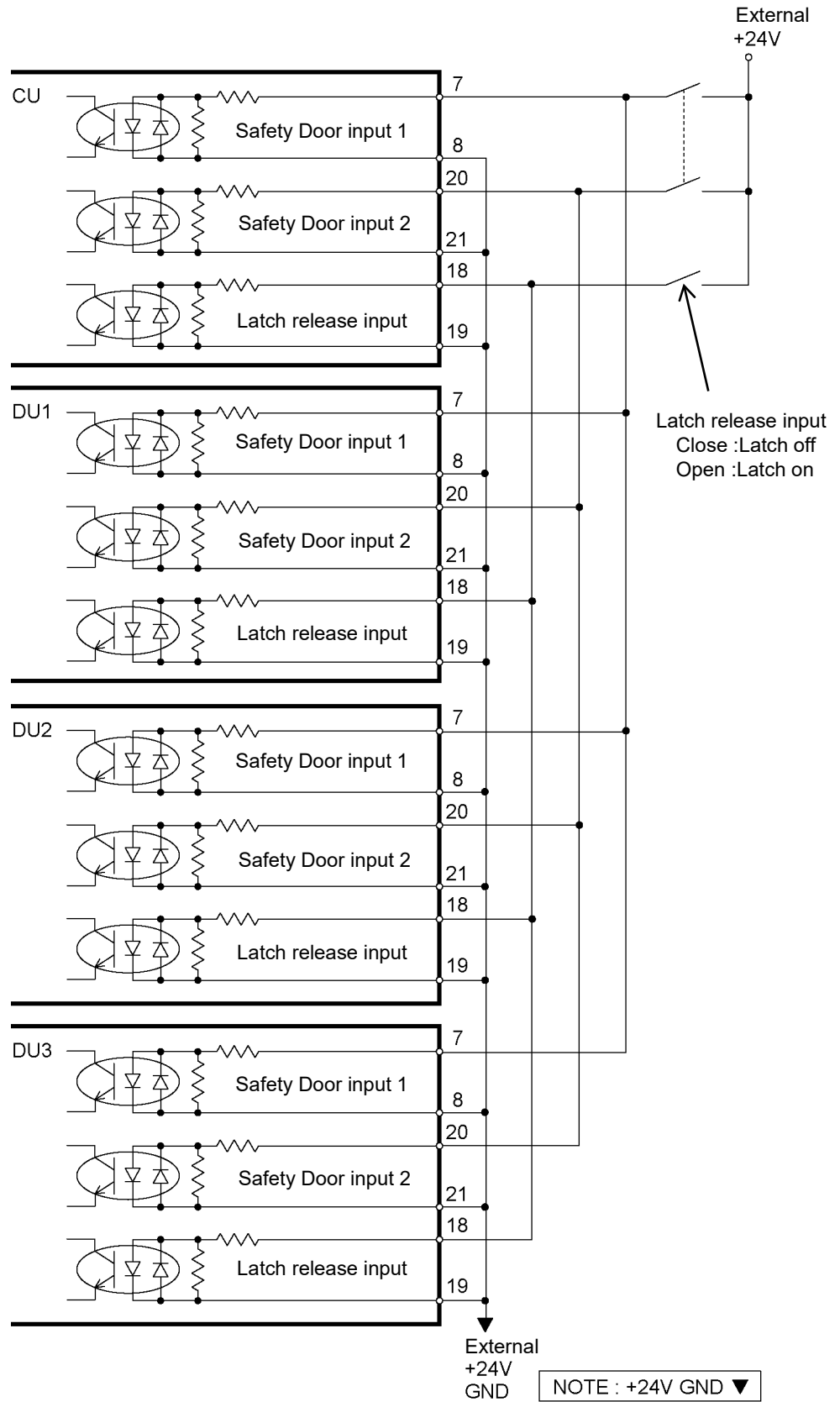

NOTE



Design the cables connecting the units within 20 m long.

## 7. I/O Connector

The I/O connector is for connecting your input/output equipment to the system.

		Pins	Bit number
Control Unit	Input	24	0 to 23
	Output	16	0 to 15
Drive Unit 1	Input	24	32 to 55
	Output	16	32 to 47
Drive Unit 2	Input	24	256 to 279
	Output	16	256 to 271
Drive Unit 3	Input	24	288 to 311
	Output	16	288 to 303

For cable wiring, refer to the *Setup & Operation 3.5 Noise Countermeasures* in order to prevent noise.

### 7.1 Input Circuit

Input Voltage Range	: +12 to 24 V $\pm$ 10%
ON Voltage	: +10.8 V (min.)
OFF Voltage	: +5 V (max.)
Input Current	: 10 mA (TYP) at +24 V input

Two types of wiring are available for use with the two-way photo coupler in the input circuit.

Typical Input Circuit Application 1

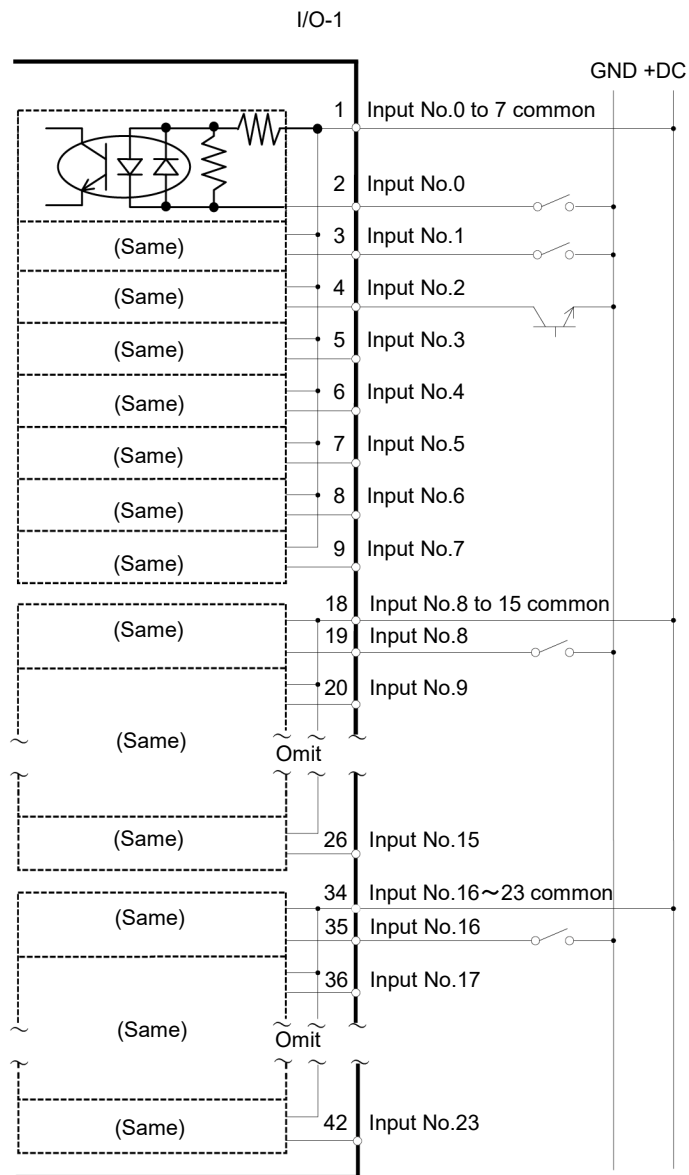

Typical Input Circuit Application 2

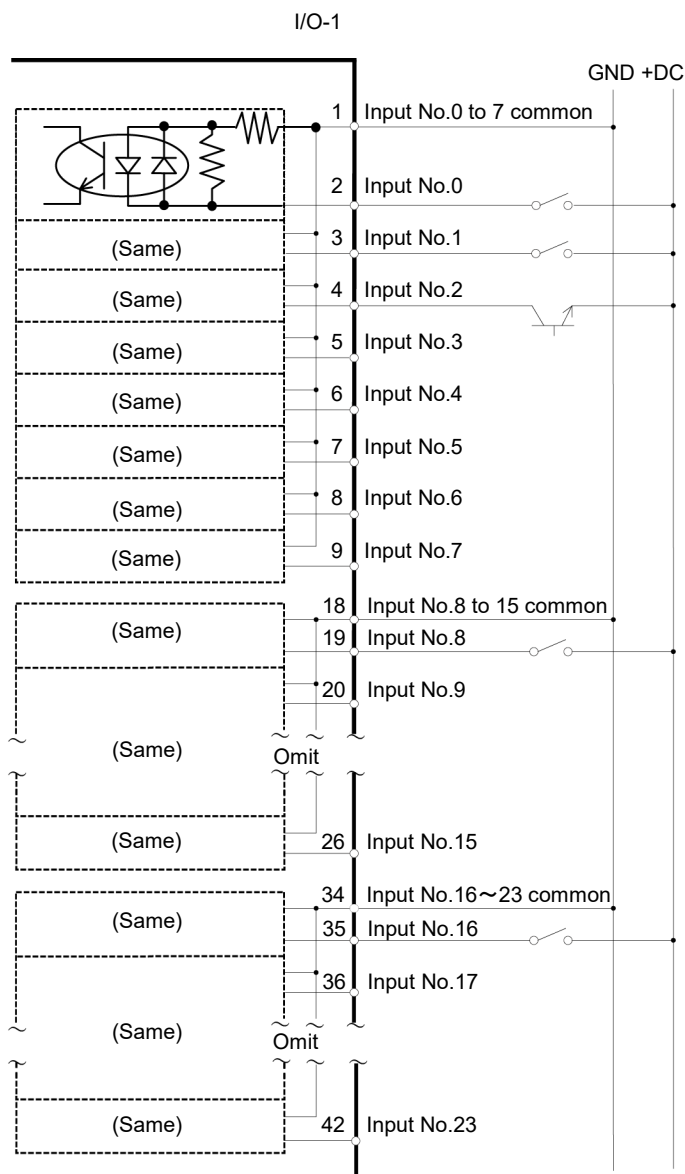

## 7.2 Output Circuit

Rated Output Voltage : +12 V to 24 V  $\pm$ 10%  
 Maximum Output Current : TYP 100 mA/1 output  
 Output Driver : PhotoMOS Relay  
 On-State Resistance (average) : 23.5  $\Omega$  or less

Two types of wiring are available for use with the nonpolar PhotoMOS relay in the output circuit.

### Typical Output Circuit Application 1: Sink Type (NPN)

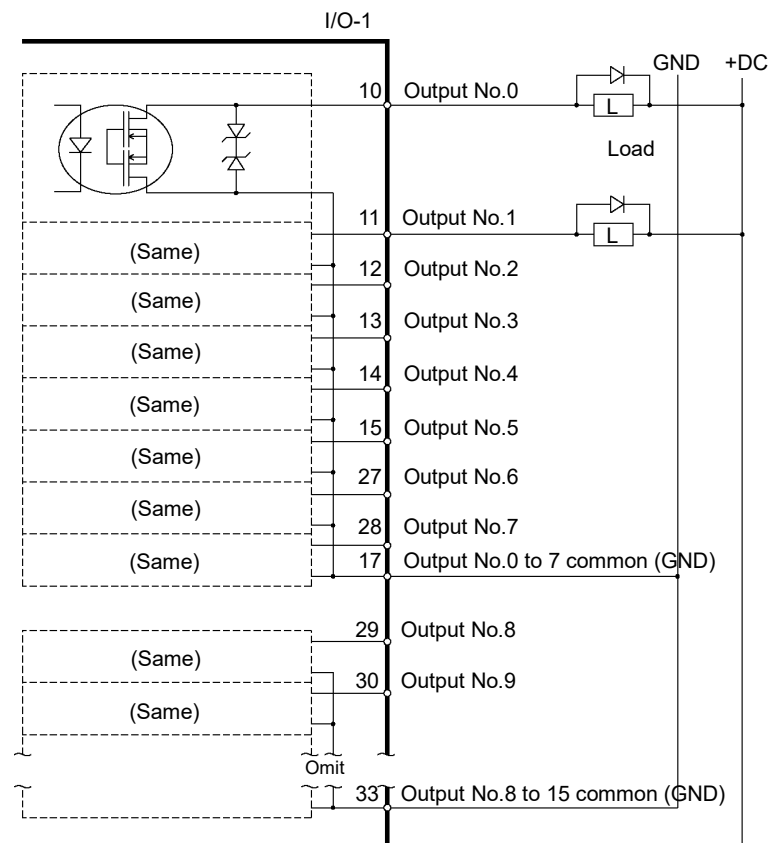

Typical Output Circuit Application 2: Source Type (PNP)

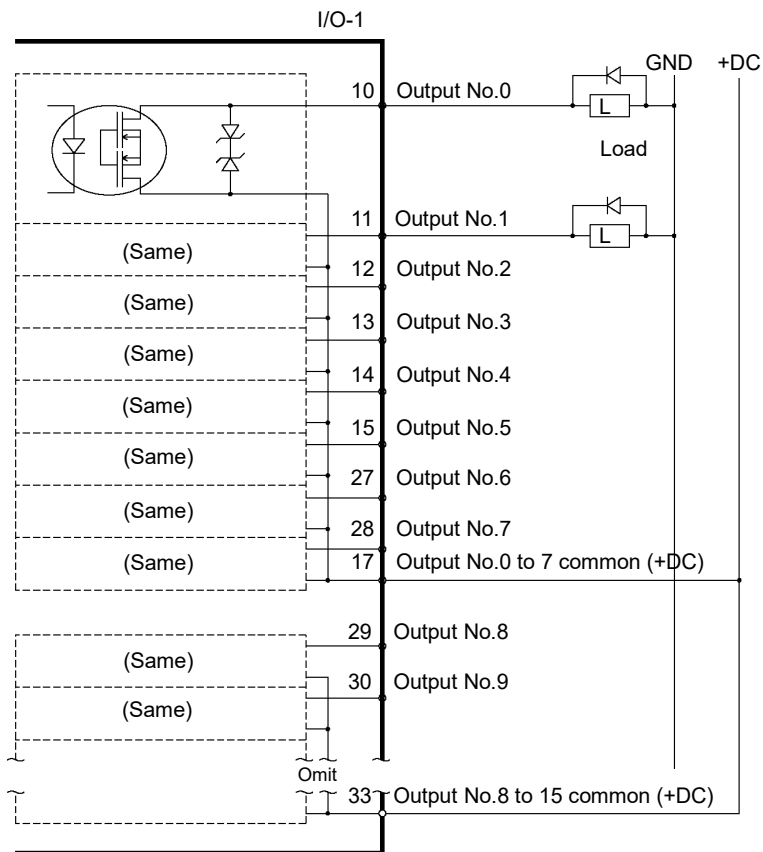

### 7.3 Pin Assignments

Pin No.	Signal Name	Pin No.	Signal Name	Pin No.	Signal Name
1	Input common No. 0 to 7	18	Input common No. 8 to 15	34	Input common No. 16 to 23
2	Input No. 0	19	Input No. 8	35	Input No. 16
3	Input No. 1	20	Input No. 9	36	Input No. 17
4	Input No. 2	21	Input No. 10	37	Input No. 18
5	Input No. 3	22	Input No. 11	38	Input No. 19
6	Input No. 4	23	Input No. 12	39	Input No. 20
7	Input No. 5	24	Input No. 13	40	Input No. 21
8	Input No. 6	25	Input No. 14	41	Input No. 22
9	Input No. 7	26	Input No. 15	42	Input No. 23
10	Output No. 0	27	Output No. 6	43	Output No.11
11	Output No. 1	28	Output No. 7	44	Output No.12
12	Output No. 2	29	Output No. 8	45	Output No.13
13	Output No. 3	30	Output No. 9	46	Output No.14
14	Output No. 4	31	Output No.10	47	Output No.15
15	Output No. 5	32	Not Used	48	Not Used
16	Not Used	33	Output common No. 8 to 15	49	Not Used
17	Output common No. 0 to 7			50	Not Used

Remote function is not initially assigned to both input and output. To assign the remote function, refer to *RC700 / RC700-A Robot Controller: Setup & Operation 12. I/O Remote Settings*.

Connector	Standard
I/O Connector (Drive Unit side)	D-sub 50 male pin Mounting style #4 - 40

\* The I/O connector, I/O connector cable, terminal block, and I/O connector kit are offered as options.

## 8. R-I/O Connector

The I/O connector is for connecting the input signals of the real time I/O function.

		Pins	Bit number
Drive Unit 1	Input	2	56, 57
Drive Unit 2	Input	2	280, 281
Drive Unit 3	Input	2	312,313

By inputting trigger signals to R-I/O, you can keep and get the operating robot position when trigger is detected. If you use this function with Vision, you can create an application of parts pickup, alignment, and assembly by robots without stopping.

For details, refer to *EPSON RC+7.0 User's Guide 18. Real time I/O*.

### 8.1 Input Circuit

- Input Voltage Range : +24 V ±10%
- Input Current : 10 mA (TYP) at +24 V input

The following two types of wiring are available in the input circuit.

#### Typical Input Circuit Application 1

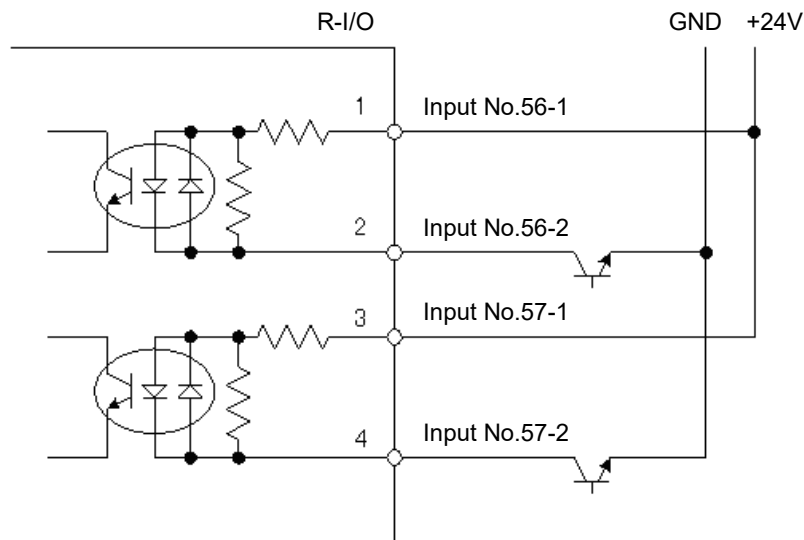



Typical Input Circuit Application 2

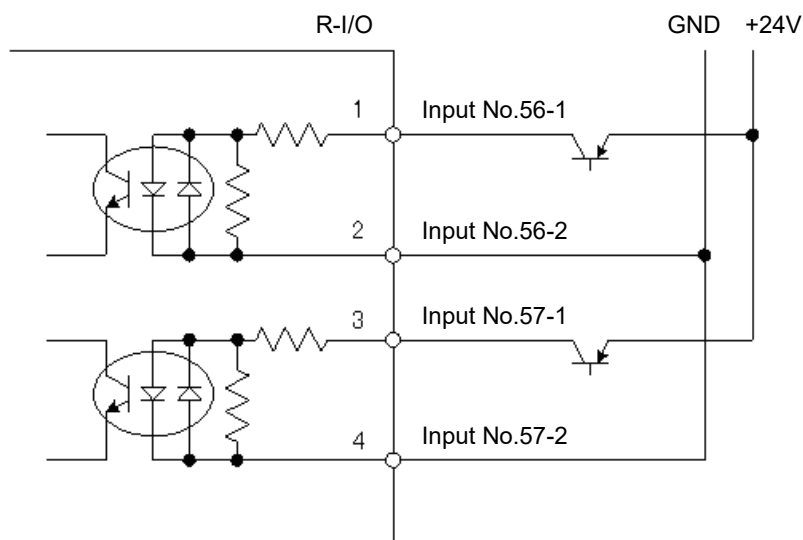

8.2 Pin Assignments

Pin No.	Signal Name (Drive Unit 1)	Signal Name (Drive Unit 2)	Signal Name (Drive Unit 3)
1	Input No.56-1	Input No.280-1	Input No312-1
2	Input No56-2	Input No.280-2	Input No312-2
3	Input No57-1	Input No.281-1	Input No313-1
4	Input No57-2	Input No.281-2	Input No313-2
5 to 15*	Not Used		

\* For the pins 5 to 15, do not connect anything.

Connector	Standard
I/O Connector (Drive Unit side)	D-sub 50 male pin Mounting style #4 - 40



CAUTION

■ When using R-I/O connector, be careful of the following points. If you use the R-I/O connector without meeting the necessary conditions, it may cause the system failure and/or safety problems.

- Use a shielded cable and route the cables as far from the surrounding noise sources as possible.  
For details, refer to *Setup & Operation: 3.5 Noise Countermeasures*.
- Make sure to check the cable routing before turning on the power supply.



# Maintenance

This section contains maintenance procedures for the Drive Unit.



## 1. Safety Precautions on Maintenance



WARNING

- Only authorized personnel who have taken the safety training should be allowed to execute teaching or calibration of the robot system.

The safety training is the program for industrial robot operator that follows the laws and regulations of each nation. The personnel who have taken the safety training acquire knowledge of industrial robots (operations, teaching, etc.).

The personnel who have completed the robot system-training class held by the manufacturer, dealer, or locally-incorporated company are allowed to maintain the robot system.

- Only authorized personnel who have taken the safety training should be allowed to maintain the robot system.

The safety training is the program for industrial robot operator that follows the laws and regulations of each nation.

The personnel who have taken the safety training acquire knowledge of industrial robots (operations, teaching, etc.), knowledge of inspections, and knowledge of related rules/regulations.

The personnel who have completed the robot system-training and maintenance training classes held by the manufacturer, dealer, or locally-incorporated company are allowed to maintain the robot system.

- Make sure to use only dedicated/specified maintenance parts especially for the optional boards or any other parts in the Control Unit / Drive Unit to be replaced. Using non-specified parts may cause serious damage to the robot system and/or serious safety problems.
- Do not remove any parts that are not covered in this manual. Follow the maintenance procedure strictly as described in this manual. Do not proceed using any methods other than described in this manual when you do replace a part or maintain the equipment. Improper removal of parts or improper maintenance may cause not only improper function of the robot system but also serious safety problems.



WARNING

- Before performing any maintenance procedure, always make sure that the main power of the Drive Unit is turned OFF, unplug the power supply, and that the high voltage charged area is completely discharged. Performing any maintenance procedure while the main power is ON or the high voltage charged area isn't discharged completely is extremely hazardous and may result in electric shock and/or cause serious safety problems.



CAUTION

- Do not touch the Motor Driver modules and Switching Power Supply directly in the Drive Unit. The metal resistance of these can become very hot and may result in a burn. If you maintain them, examine the surface temperatures and wear protective gloves if necessary.
- Do not shock, shake, or drop any parts during maintenance. When the parts related with data are shocked physically, they may be damaged and may also cause data loss during data loading/saving.

 CAUTION	<ul style="list-style-type: none"> <li>■ Do not lose the screws removed at maintenance. When the screw is dropped into the Drive Unit, be sure to take it out. Leaving the screw in the Drive Unit may cause short circuit and may result in equipment damage to the parts and/or robot system.</li> <li>■ Make sure that the power rating (wattage) of a new Motor Driver module is correct. Using a Motor Driver module with improper power rating (wattage) in the Drive Unit may cause improper function of the robot system and errors.</li> <li>■ The serial number of the Manipulator that should be connected is indicated on the Connection Check Label on the Drive Unit. Connect the Drive Unit and the Manipulator correctly. Improper connection between the Drive Unit and the Manipulator may cause not only improper function of the robot system but also serious safety problems.</li> </ul>
--	--

NOTE  Before performing maintenance on the Drive Unit, all the data must be copied as a backup. The details of data backup/restore are described in *Robot Controller RC700 / RC700-A Maintenance 4. Backup and Restore*.

## 2. Regular Maintenance Inspection

Performing regular maintenance inspection properly is essential for preventing trouble and maintaining safety. This chapter describes the schedules for maintenance inspection and procedures.

Be sure to perform the maintenance inspections in accordance with the schedules.

Part Content	Fan filter		Fan (Front)	Fan (Rear)
	Cleaning	Replacement	Replacement	Replacement
Code	-	2195106	2157260	2157260
Quantity	-	1	1	1
Maintenance interval	More than once a month is recommended	When the filter gets deteriorated	When the error * 525, 535, 545 occurs, or when the abnormal noise occurs	When the error * 526, 536, 546 occurs, or when the abnormal noise occurs
Possible malfunction if maintenance is not performed	The temperature inside the Drive Unit may get too high and the robot system may not operate properly. The error may occur due to reduction of the fan rotation.	The robot system may not operate properly due to dust or the like.	One of the errors * 9025, 9035, or 9045 occurs and the robot system may stop.	One of the errors * 9026, 9036, or 9046 occurs and the robot system may stop.
Duration (reference)	5 minutes	5 minutes	20 minutes	15 minutes
Reference: Maintenance	4.1 <i>Fan Filter</i>	4.1 <i>Fan Filter</i>	4.2.1 <i>Front Fan</i>	4.2.2 <i>Fan 2 (RC700DU-A only)</i>
Expected product life	-	-	30,000 hours	30,000 hours

\* The error number depends on the number of Drive Units.

# 3. Drive Unit Structure

## 3.1 Location of Parts

### 3.1.1 RC700DU

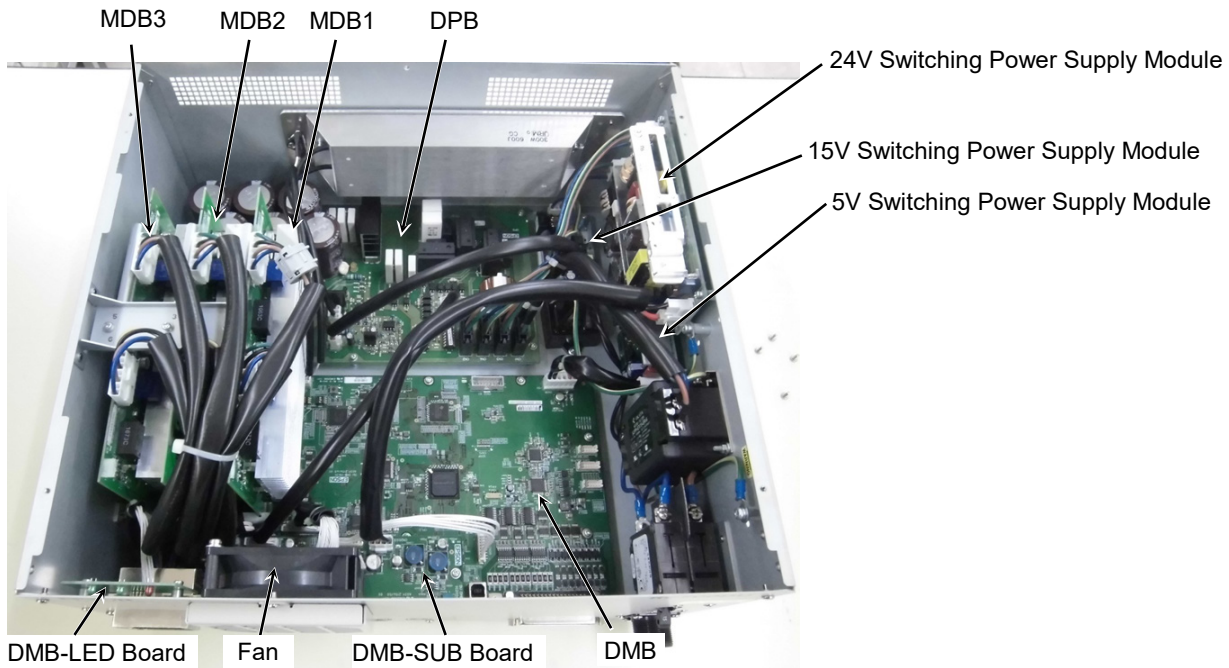

### 3.1.2 RC700DU-A

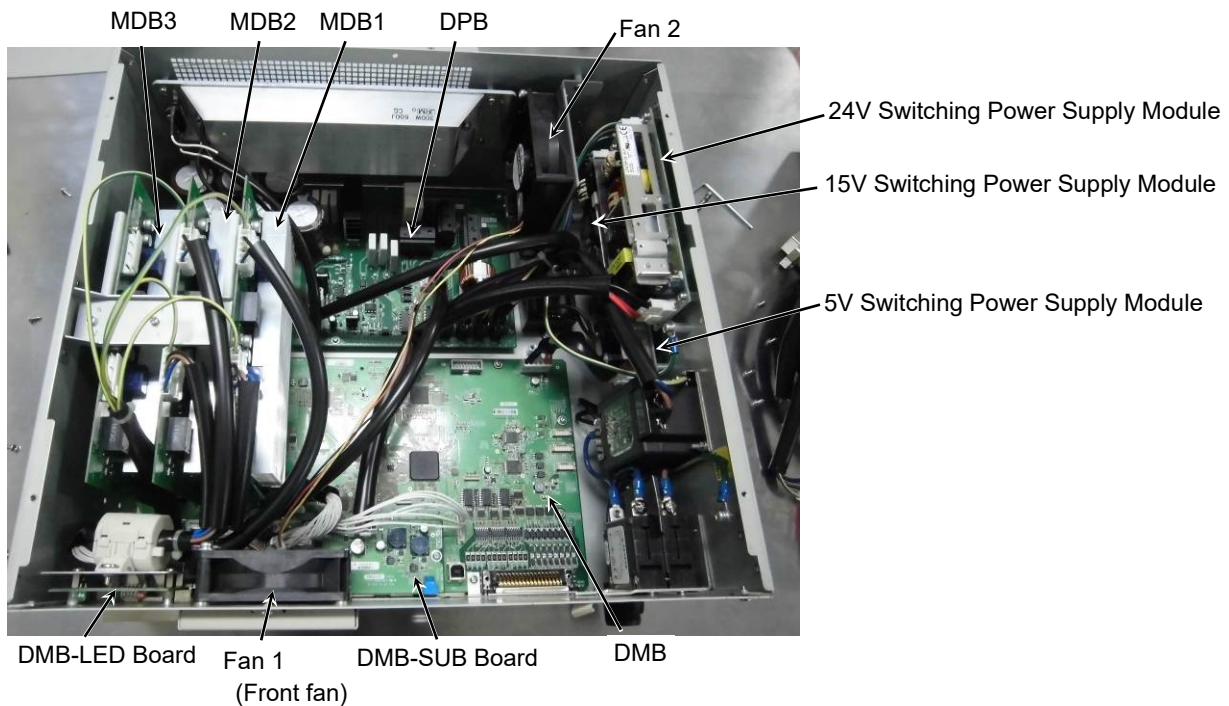

(MDB3 is not supplied for G1, G3, G6, G10, G20, RS and X5.)



## 3.2 Diagram of Cable Connections

### 3.2.1 RC700DU

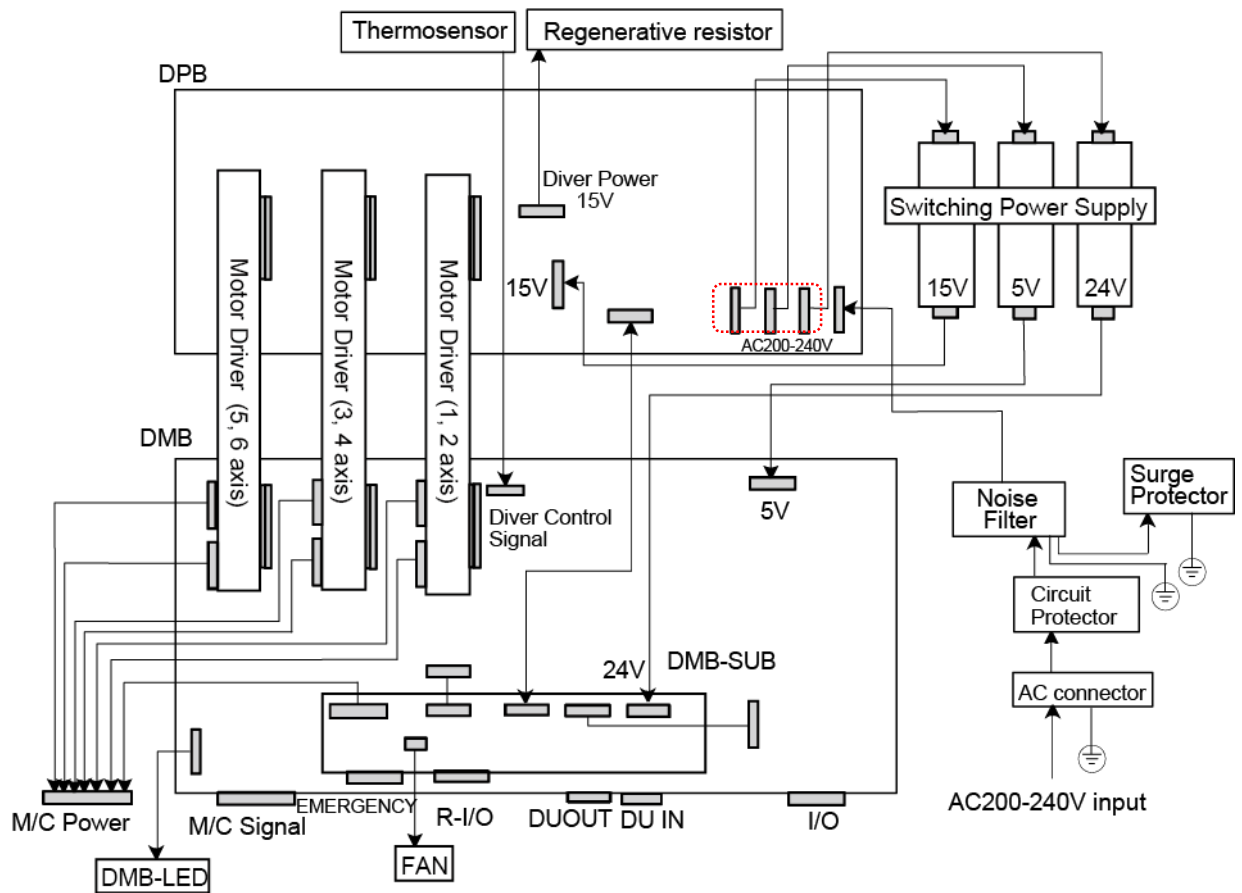

(Connecters in the red dotted line work properly in any order.)

3.2.2 RC700DU-A

C4, C8, G1, G3, G6, G10, G20, RS, X5

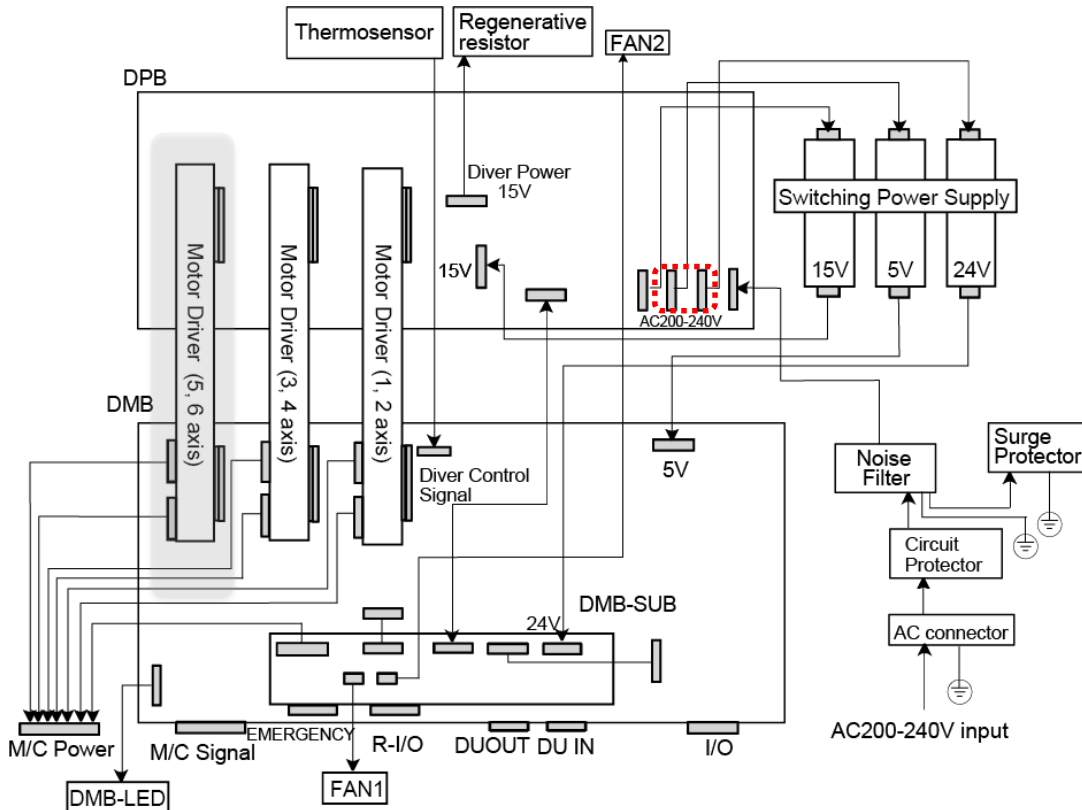

(Motor Driver (5, 6 axis) is not supplied for G1, G3, G6, G10, G20,RS and X5.)  
 (Connectors in the red dotted line work properly in any order.)

N6

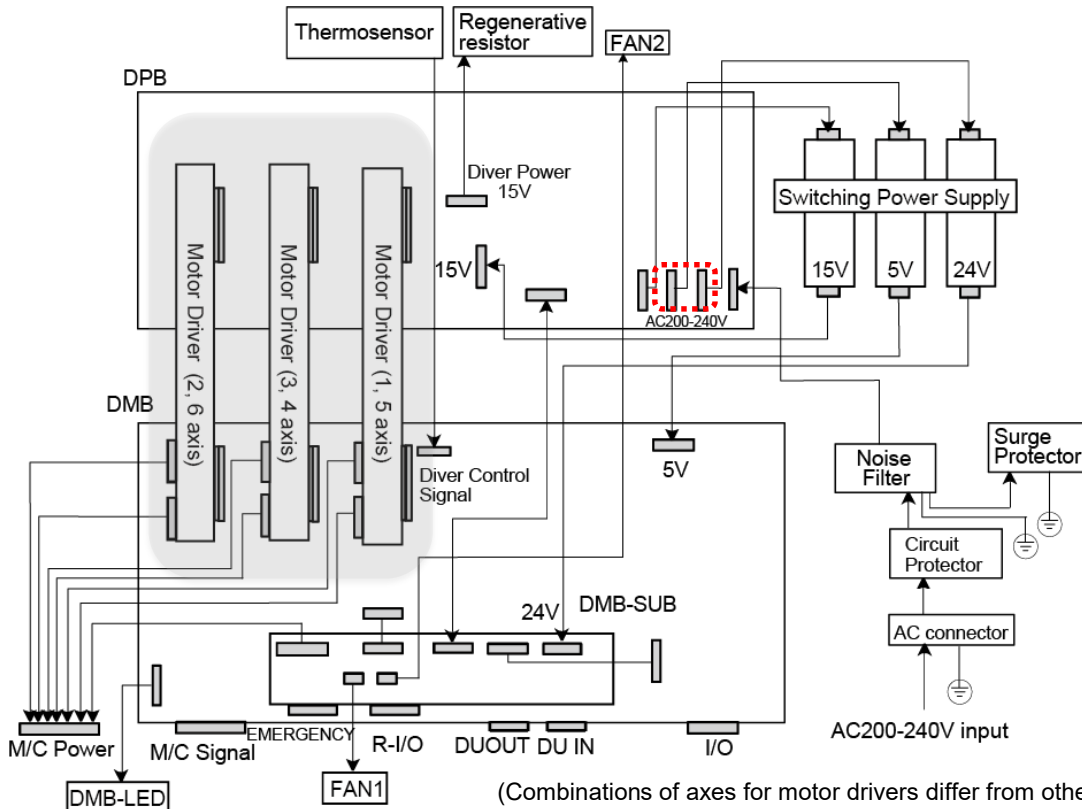

(Combinations of axes for motor drivers differ from other manipulators.)  
 (Connectors in the red dotted line work properly in any order.)

## 4. Maintenance Parts Replacement Procedures

 <b>WARNING</b>	<ul style="list-style-type: none"> <li>■ Before performing any maintenance procedure, always make sure that the main power of the Drive Unit is turned OFF and that the high voltage charged area is completely discharged. Performing any maintenance procedure while the main power is ON or the high voltage charged area is not discharged completely is extremely hazardous and may result in electric shock and/or cause serious safety problems.</li> <li>■ When opening or closing the front side, make sure that the 200 V power supply for the Drive Unit is OFF. Performing procedure to the power supply terminal block inside the Drive Unit while the power supply is ON is extremely hazardous and may result in electric shock and/or cause serious safety problems.</li> </ul>
---	---

**NOTE**



- Be careful not to damage cables. Be sure not to drop any screws into the Drive Unit.
- Installing the front cover using the wrong screws may result in a cable being damaged and/or malfunction of the Drive Unit.

### 4.1 Fan Filter

Inspect the fan filter periodically and clean it when needed. The temperature inside the Drive Unit may get too high and the Drive Unit may not operate properly if the filter is not kept clean.

**Fan Filter Removal**

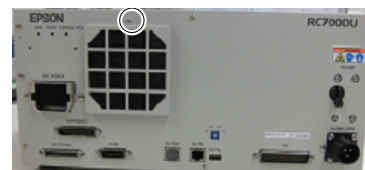
- (1) Turn OFF the Drive Unit.
- (2) Remove one screw of the fan filter.
- (3) Remove the fan filter cover.
- (4) Detach the fan filter.



Clean the fan filter as needed.

**Fan Filter Installation**

- (1) Set the fan filter to the fan filter cover.
- (2) Mount the fan filter cover with the screw.
- (3) Plug in the power plug. Turn ON the Drive Unit and make sure that the Drive Unit starts properly without any vibration or abnormal noise.

## 4.2 Fan

### 4.2.1 Front Fan

#### Front Fan Removal

- (1) Turn OFF the Drive Unit.
- (2) Unplug the power supply.
- (3) Remove the Top Cover. (Mounting screw ×6)

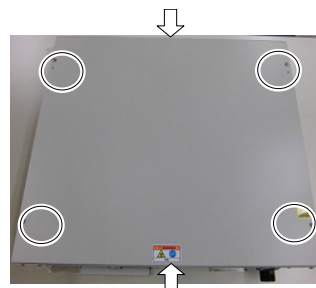

- (4) Remove the fan cable from the DMB-SUB.

Connector: CN22



- (5) Remove the screws of the fan (×2).
- (6) Remove the fan.



#### Front Fan Installation

- (1) Mount a new fan with two screws.  
At this point, tighten the screws diagonally. Be careful of the mounting direction.
- (2) Connect the fan cables to the DMB-SUB.  
Connector: CN22
- (3) Mount the Top Panel. (Mounting screw ×6)
- (4) Plug in the power plug. Turn ON the Drive Unit and make sure that the Drive Unit starts properly without any vibration or abnormal noise.

\* Pay attention to the right and wrong sides of the fan when installing it.

4.2.2 Fan 2 (RC700DU-A only)

The Fan 2 is installed only in RC700DU-A.

Fan 2  
Removal  
(RC700DU-A  
only)

- (1) Turn OFF the Drive Unit.
- (2) Unplug the power supply.
- (3) Remove the Top Cover. (Mounting screw ×6)

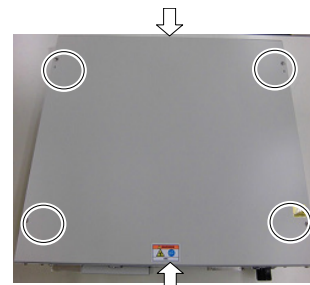

- (4) Remove the cable tie binding the 15 V power supply cable and fan cable.
- (5) Remove the fan extension connector.

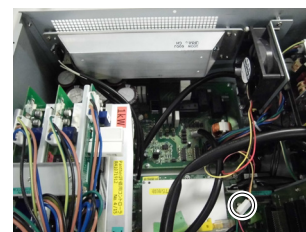

- (6) Remove the regenerative module connector from the DMB.
- (7) Remove the regenerative module connector from the DPB.
- (8) Remove the rear plate from the body.  
(Mounting screw ×5)



- (9) Remove the regenerative resistance from the rear plate.  
(Mounting screw ×4)

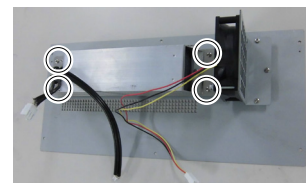

- (10) Remove the fan from the fan fixing plate.  
(Mounting screw ×2)

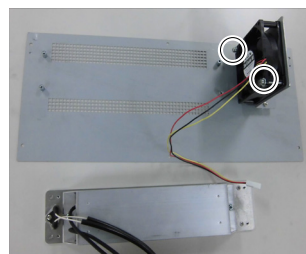

Fan 2 Installation (1) Fix the new fan to the fan fixing plate. (Mounting screw ×2)  
(RC700DU-A only)

At this point, tighten the screws diagonally. Be careful of the mounting direction.

(2) Mount the regenerative resistance to the rear plate. (Mounting screw ×2)

Be careful of the mounting direction.

(3) Mount the rear plate to the body. (Mounting screw ×5)

(4) Connect the regenerative module connector to the DMB.

(5) Connect the regenerative module connector to the DPB.

(6) Connect the fan extension connector.

(7) Bind the 15 V power supply cable and fan cable. by the cable tie (AB150).

Leave 110 mm from the end of the cable tie in order not to tighten the cables too much.

Cut the excess part of the tie.

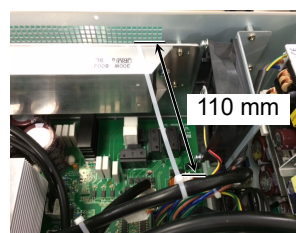

(8) Mount the Top Panel. (Mounting screw ×6)

(9) Plug in the power plug. Turn ON the Drive Unit and make sure that the Drive Unit starts properly without any vibration or abnormal noise.

\* Pay attention to the right and wrong sides of the fan when installing it.

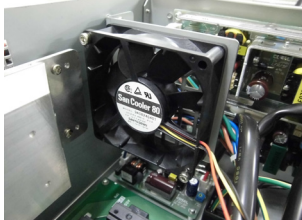

### 4.3 MDB

MDB identification method There are types of the MDB and it can be identified by “Assy. No.” or “MDB type” printed on the board.

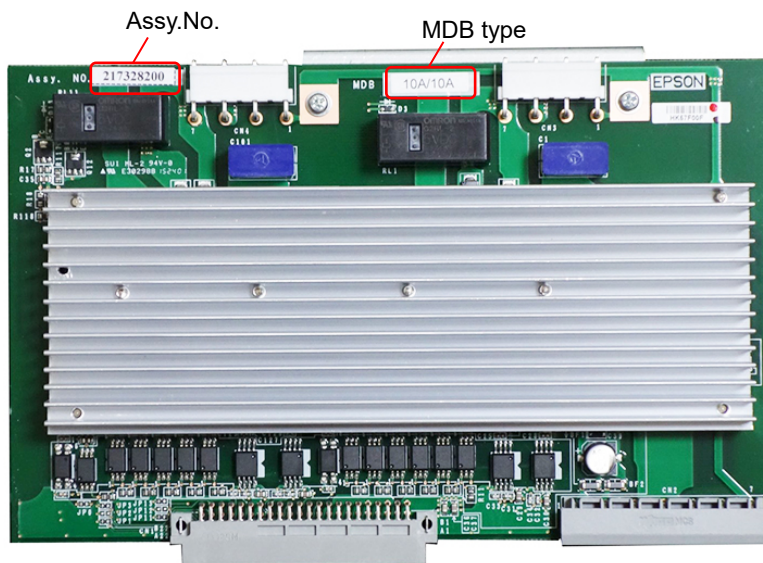

Drive Unit	Manipulator	Joint #1, #2	Joint #3, #4	Joint #5, #6	Remarks
RC700DU	C4	15A/15A	10A/10A		MDB type
		2149935** 2171247**	2145517** 2157372** 2172039**		Assy. No.
RC700DU-A	C4	15A/15A-2	10A/10A		MDB type
		2166640** 2171936** 2172974** 2175538** 2194708** 2168582** 2194709**	2145517** 2157372** 2172973** 2175537** 2195535** 2172039** 2195537**		Assy. No.
		50A/30A	15A/15A-2	10A/10A	MDB type
		2169285** 2205667** 2205668**	2166640** 2171936** 2194708** 2194709**	2145517** 2157372** 2195535** 2195537**	Assy. No.
		30A/5A	15A/5A	30A/5A	MDB type
		2186906** 2188814**	2186907** 2188815**	2186906** 2188814**	Assy. No.

Maintenance 4. Maintenance Parts Replacement Procedures

Drive Unit	Manipulator	Joint #1, #2	Joint #3, #4	Remarks	
RC700DU-A	G1 G3	10A/10A		MDB type	
		2145517**		Assy. No.	
		2157372**			
	G6 RS X5	15A/15A-2		10A/10A	MDB type
		2166640**		2145517**	Assy. No.
		2171936**		2157372**	
		2168582**		2172039**	
	G10 G20	30A/30A		15A/15A-2	MDB type
		2146123**		2166640**	Assy. No.
		2153723**		2171936**	
2171456**		2168582**			



MDB Removal

- (1) Turn OFF the Drive Unit.
- (2) Remove the power plug.
- (3) Remove the Top Panel. (Mounting screw × 6)

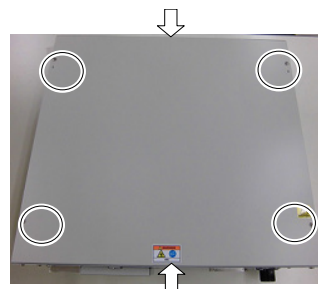

- (4) Remove the output cables of each axis of the MDB.



NOTE Before removing the cables, check positions of the boards and the cables. Install them to the same positions after the replacement.

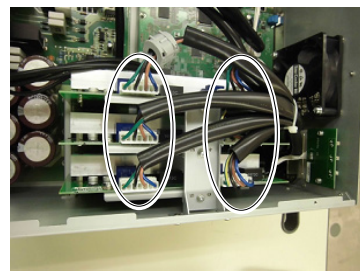

- (5) Remove the MDB clamp 1. (Mounting screw × 5)



- (6) Remove the MDB clamp 2. (Mounting screw × 2)

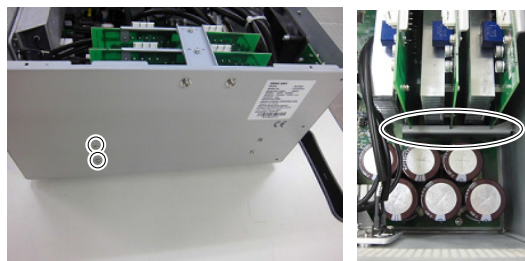

- (7) Remove the MDB clamp 3. (Mounting screw × 2)

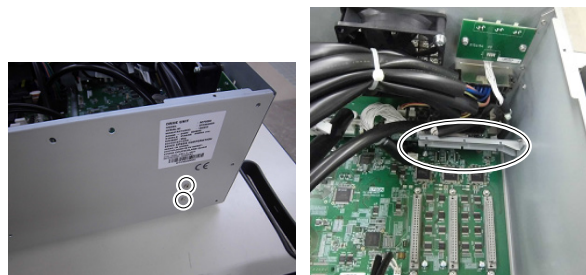

- (8) Pull out the MDBs in the direction shown in the picture.



NOTE When removing the MDBs, make sure to remember the position of each board. Install the boards to the same positions after replacement.

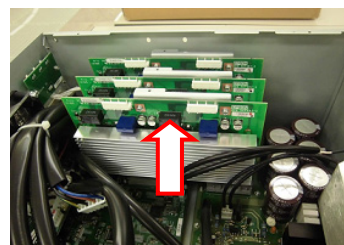

MDB  
Installation

- (1) Install the MDB clamp 3.  
(Mounting screw × 2)

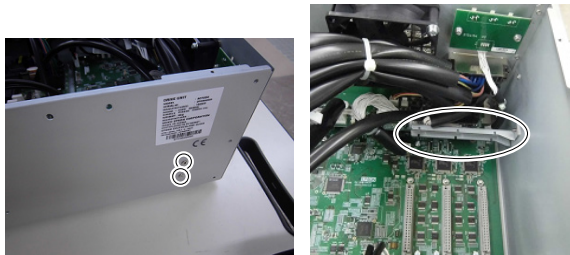

- (2) Insert the MDBs in the direction shown in the picture.

NOTE  

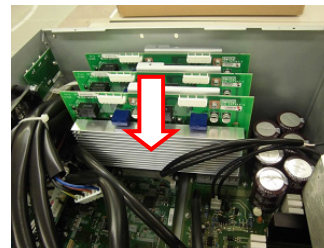

Be careful not to misplace the boards.

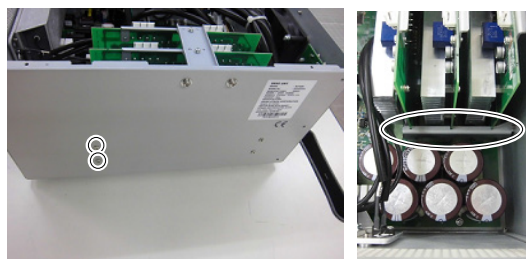

- (3) Install the MDB clamp 2.  
(Mounting screw × 2)
- Set the MDB clamp so that the grooves fit to MDBs.

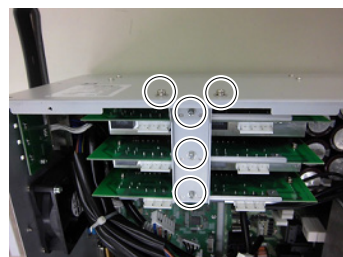

- (4) Mount the MDB clamp 1.  
(Mounting screw × 5)



- (5) Mount the output cable of each axis of the MDBs.

NOTE  

When mounting the output cables, make sure that the numbers on the MDB clamp 1 and on the connectors are the same.

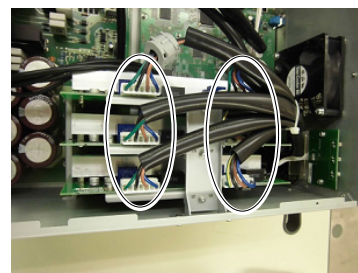

- (6) Mount the Top Panel. (Mounting screw ×6)
- (7) Plug in the power plug. Turn ON the Drive Unit and make sure that the Drive Unit starts properly without any vibration or abnormal noise.

**4.4 DMB**

DMB  
Removal

- (1) Turn OFF the Drive Unit.
- (2) Remove the power plug.
- (3) Remove the Top Panel. (Mounting screw ×6)

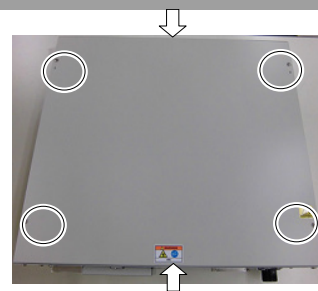

- (4) Remove the cables connected to the following connectors.
 

M/C Signal Connector	EMERGENCY Connector
R-I/O Connector	DU OUT Connector
DU IN Connector	I/O Connector

- (5) Remove the MDBs.  
Refer to *Maintenance: 4.3 MDB*.

- (6) Remove the five connectors from the DMB.

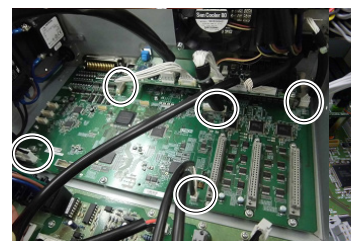

- (7) Remove the DMB mounting screws (×15).

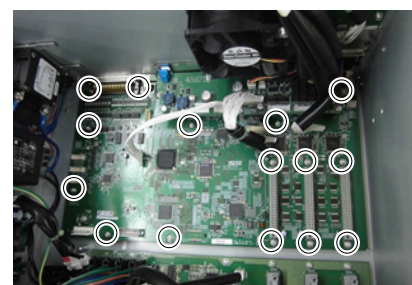

- (8) Remove the fan.  
Refer to *Maintenance: 4.2 Fan*.

- (9) Remove the DMB from the chassis.  
At this point, be careful not to touch the chassis and other parts.

- (10) Remove the plate fixing the connectors on the front side from the DMB and the DMB-SUB boards.



- (11) Remove the DMB-SUB board from the DMB.  
(Mounting screw × 3)



DMB  
Installation

- (1) Install the DMB-SUB board to the new DMB. (Mounting screw × 3)
- (2) Install the plate that secures the connectors on the front side to the DMB and the DMB-SUB boards.
- (3) Insert the DMB into the chassis.

At this point, be careful not to touch the chassis and other parts.

- (4) Mount the fan.  
Refer to *Maintenance: 4.2 Fan*.
- (5) Tighten the DMB mounting screw (×15).

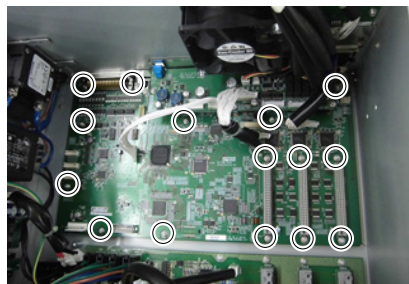

- (6) Mount the five connectors to the DMB.

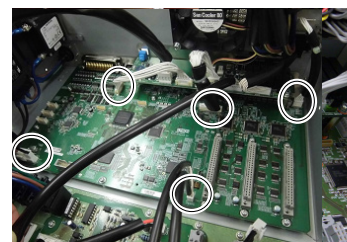

- (7) Mount the MDB.  
Refer to *Maintenance: 4.3 MDB*.
- (8) Install the cables to the following connectors.

M/C Signal Connector	EMERGENCY Connector
R-I/O Connector	DU OUT Connector
DU IN Connector	I/O Connector

- (9) Mount the Top Panel. (Mounting screw ×6)
- (10) Plug in the power plug. Turn ON the Drive Unit and make sure that the Drive Unit starts properly without any vibration or abnormal noise.

## 4.5 DMB-SUB Board

### DMB-Sub Board Removal

- (1) Turn OFF the Drive Unit.
- (2) Remove the power plug.
- (3) Remove the Top Panel. (Mounting screw ×6)

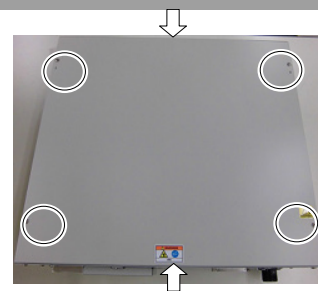

- (4) Remove the cables from the DMB-SUB board.

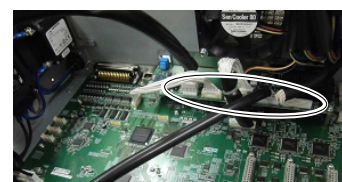

- (5) Remove the screws fixing the DMB-SUB board to the front side plate.



- (6) Remove the DMB-SUB Board from the DMB.  
(Mounting screws ×3)

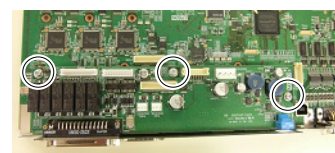

### DMB-Sub Board Installation

- (1) Mount the plate that secures the connectors on the front side to the DMB-SUB board.
- (2) Mount the DMB-SUB Board to the DMB. (Mounting screws ×3)
- (3) Connect the cables to the DMB-SUB Board.
- (4) Mount the Top Panel. (Mounting screw ×6)
- (5) Set the Encoder Voltage Adjustment Switch.

Set the Encoder Voltage Adjustment Switch according to the length of the M/C cable.

Refer to: *Setup & Operation 2. Part Names and Functions*

(9) *Encoder Voltage Adjustment Switch*

- (6) Plug in the power plug. Turn ON the Drive Unit and make sure that the Drive Unit starts properly without any vibration or abnormal noise.

## 4.6 DMB-LED Board

### 4.6.1 DMB-LED Board (RC700DU)

#### DMB-LED Board Removal (RC700DU)

- (1) Turn OFF the Drive Unit.
- (2) Unplug the power plug.
- (3) Remove the Top Panel. (Mounting screw ×6)
- (4) Disconnect the cables connected to the DMB-LED board.
- (5) Remove the DMB-LED board. (Mounting screw ×2)

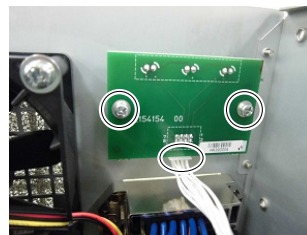
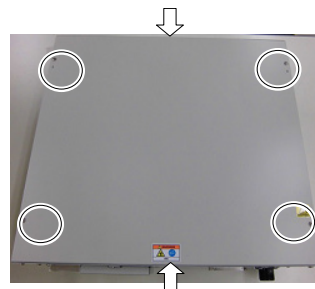

#### DMB-LED Board Installation (RC700DU)

- (1) Mount the DMB-LED board. (Mounting screw ×2)
- (2) Connect the cables to the DMB-LED board.
- (3) Mount the Top Panel. (Mounting screw ×6)
- (4) After connecting the power plug, turn ON the Drive Unit and make sure that the Drive Unit starts properly without any vibration or abnormal noise.

4.6.2 DMB-LED Board (RC700DU-A)

DMB-LED Board Removal  
(RC700DU-A)

- (1) Turn OFF the Drive Unit.
- (2) Unplug the power plug.
- (3) Remove the Top Panel. (Mounting screw ×6)
- (4) Remove the DMB-LED board from the front panel. (Mounting screw ×2)
- (5) Remove the ferrite core from the Support plate. (Mounting screw ×1)
- (6) Disconnect the cables connected to the DMB-LED board.
- (7) Remove the DMB-LED board from the support plate. (Nut ×2)
- (8) Remove the stud bolt from the DMB-LED board. (Stud bolt × 4)

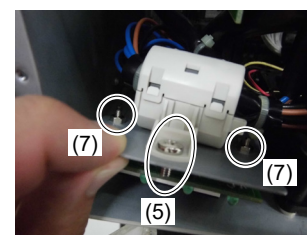
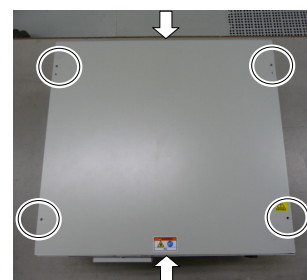

DMB-LED Board Installation  
(RC700DU-A)

- (1) Mount the stud bolt to the DMB-LED board. (Stud bolt × 4)
- (2) Mount the DMB-LED board to the support plate. (Nut ×2)
- (3) Connect the cable to the DMB-LED board.
- (4) Mount the ferrite core to the support plate. (Mounting screw × 1)
- (5) Mount the DMB-LED board to the front panel. (Mounting screw ×4)
- (6) Mount the Top Panel. (Mounting screw ×6)
- (7) After connecting the power plug, turn ON the Drive Unit and check it works normally without vibration and abnormal sound.

## 4.7 DPB

### DPB Removal

- (1) Turn OFF the Drive Unit.
- (2) Unplug the power plug.
- (3) Remove the Top Panel. (Mounting screw × 6)
- (4) Remove the MDB.  
Refer to: Maintenance 4.3 MDB
- (5) Remove eight connectors from the DPB.

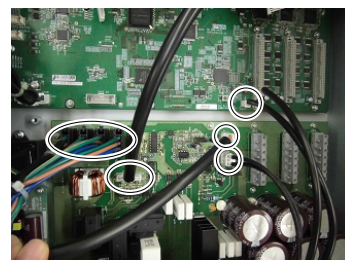
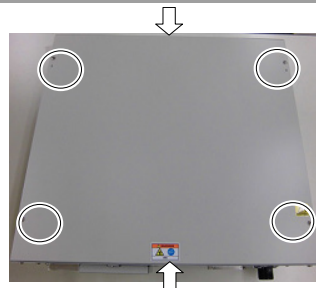

- (6) RC700DU-A only:  
Remove the Fan 2 extension connector.

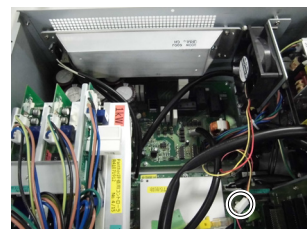

- (7) RC700DU-A only:  
Remove the rear plate from the body.  
(Mounting screw × 5)



- (8) Remove the DPB mounting screws.  
(Mounting screw × 12)

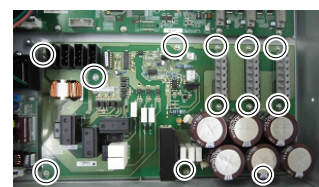

- (9) Remove the DPB from the chassis.



DPB  
Installation

- (1) Insert the DPB to the chassis.
- (2) Fix the DPB with screws. (Mounting screw × 12)
- (3) RC700DU-A only: Mount the rear plate. (Mounting screw × 5)
- (4) RC700DU-A only: Connect the Fan 2 extension connector.
- (5) Connect the eight connectors to the DPB.
- (6) Mount the DMB.  
Refer to: *Maintenance 4.4 DMB*
- (7) Mount the top plate. (Mounting screw × 6)
- (8) After connecting the power plug, turn ON the Drive Unit and check it works normally without vibration and abnormal sound.

## 5. Verifying Robot System Operation

When maintenance has been performed for the Manipulator, the Control Unit, or the Drive Unit including replacing any parts in those units, items must be checked according to the procedures in this section to ensure proper operation.



Check the LED status of the Control Unit by following the steps below.

- (1) Connect all the necessary cables for the system.

 WARNING	<ul style="list-style-type: none"> <li>■ When verifying the robot system operation, prepare for failures with initial settings or wiring. If the Manipulator operates abnormally because of incorrect initial settings or wiring, press the Emergency Stop switch immediately to stop the Manipulator.</li> </ul> <p>Verify the robot system operation in the restricted mode (low speeds and low power) status. Verifying the robot system operation at high speeds may damage the robot system and/or cause serious safety problems as the Manipulator cannot stop operating immediately in case of abnormal operation of the Manipulator.</p>
--	--

 CAUTION	<ul style="list-style-type: none"> <li>■ The serial number of the Manipulator that should be connected is indicated on the Connection Check Label on the Control Unit and the Drive Unit. Connect the Control Unit / Drive Unit and the Manipulator correctly. Improper connection between the Control Unit / Drive Unit and the Manipulator may cause not only improper function of the robot system but also serious safety problems.</li> </ul>
--	--

- (2) Check the LED status during the time from the Control Unit and the Drive Unit are turned ON until the Control Unit boots up by referring to the list below.

	From power-on to boot	While running	
LED	All blink	LED for current operation mode (TEST, TEACH, AUTO, PROGRAM) turns ON.	
7 segment	All lights out		READY (Normal)
			Emergency Stop
			Safeguard
		Four digits	Error

For details of the display, refer to *Robot Controller RC700 / RC700-A Setup & Operation 2.1 LED and Seven-segment LED*.

For error numbers, refer to *Robot Controller RC700/ RC700-A manual* or *EPSON RC+ 7.0 SPEL+ Language Reference*.

- (3) Execute MOTOR ON and check the following:
  - No error is displayed.
  - There is servo excitation and the Manipulator operates normally.
- (4) Execute various motion commands (such as JUMP, etc.). The Manipulator must operate accordingly and normally without vibration or unusual sounds.

## 6. Troubleshooting

### 6.1 Error Code Table

For error numbers, refer to the *Robot Controller RC700 / RC700-A* manual or the *EPSON RC+ 7.0 SPEL+ Language Reference*.

## 7. Maintenance Parts List

Part Name		Code	Old Code	Note
Fan		2157260	R13B060510	
Fan Filter		1596688	R13N865021	Black (While stock lasts)
		2195106	—	White
Motor Driver	10A/10A	2172039	R13N874011	See the table below for motor selection Common: RC700 / RC700-A
		2195537	—	
	15A/5A	2188815	—	
	15A/15A	2171247	R13N874021	
	15A/15A-2	2168582	—	
		2194709	—	
	30A/5A	2188814	—	
30A/30A	2171456	R13NZ90002		
DMB-MAIN	For RC700DU	2157193	R13NZ90003	
	For RC700DU-A	2204998	—	
DMB-SUB		2157195	R13NZ90004	For C4, C8 series
		2171817	—	For G, RS, X5 series
DMB-LED		2157209	R13NZ90005	
DPB	For RC700DU	2171246	R13N844011	Common: RC700
	For RC700DU-A	2171263	—	Common: RC700-A

### Motor driver (\*\* A / \*\* A)

Drive Unit	Manipulator	Joint #1, #2	Joint #3, #4	Joint #5, #6	Remarks
RC700DU	C4	15A/15A	10A/10A		MDB type
		2171247	2172039		Code
		R13N874021	R13N874011		Old Code
RC700DU-A	C4	15A/15A-2	10A/10A		MDB type
		2194709	2195537		Code
	C8	50A/30A	15A/15A-2	10A/10A	MDB type
		2205668	2194709	2195537	Code
	N6	30A/5A	15A/5A	30A/5A	MDB type
		2188814	2188815	2188814	Code

Drive Unit	Manipulator	Joint #1, #2	Joint #3, #4	Remarks
RC700DU-A	G1 G3	10A/10A		MDB type
		2172039		Code
		R13N874011		Old Code
	G6 RS X5	15A/15A-2	10A/10A	MDB type
		2168582	2172039	Code
		—	R13N874011	Old Code
	G10 G20	30A/30A	15A/15A-2	MDB type
		2171456	2168582	Code
		R13NZ90002	—	Old Code