

THE POWER OF



Cables & Value Pack

**SRC0001, SRC0002,
SRC0003, SRC0006,
SRC0008, SRC0009,
SRC0010, SRC0011,
SRC0012, SRC0016,
SRC0017, SRC0018,
SRC0019, SRPA20-VP,
SRC0001-CK**

REDARC SOLAR CABLES AND VALUE PACK

REDARC Solar Cables are suitable for use with REDARC Solar products. REDARC Solar products include Solar Panels, Solar Blankets, Solar Regulators and REDARC BDC / BMS Battery chargers. The cables feature UV stabilised PVC insulation for outdoor applications, and use genuine Anderson™ to Anderson™ SB™ 50 connectors with silver plated terminals.

The REDARC Solar Value Pack (SRPA20-VP) includes a 5 m Anderson™ to Anderson™ cable (SRC0018), a 1.5 m Anderson™ to Battery Clip cable (SRC0009) and a 20 A Solar Regulator (SRPA0240). All products in the REDARC Solar Value Pack (SRPA-VP) use Anderson™ SB™ 50 connectors with silver plated terminals.

WARNING AND SAFETY INSTRUCTIONS

SAVE THESE INSTRUCTIONS - THIS MANUAL CONTAINS IMPORTANT SAFETY INSTRUCTIONS FOR REDARC SOLAR CABLES.

Do not operate Solar products unless you have read and understood their associated manuals, and the system is set up as per their instructions. REDARC recommends that any Solar product is installed by a suitably qualified person.

WARNING

RISK OF EXPLOSIVE GASES:

Working in the vicinity of lead-acid batteries is dangerous. Batteries generate explosive gases during normal operation. For this reason, it is of utmost importance that you follow the instructions when installing and using Solar products.

RISK OF EXPLOSIVE GASES:

Batteries should be mounted in a well ventilated area, as far as possible from any ignition sources. NEVER smoke or allow a spark or flame in the vicinity of a battery or engine. This may cause the battery to explode.

RISK OF OVERCHARGING:

Check the manufacturer's data for your battery and ensure that the voltage of the profile you select does not exceed the manufacturer's recommended maximum charging voltage. If the maximum voltage for your battery type is too high, please select another charging profile.

RISK OF DAMAGE AND INJURY FROM IMPROPERLY SECURED PANELS:

Solar panels mounted to all types of vehicles, including but not limited to, 4x4 Vehicles, RVs, Caravans, are subject to high wind and vibration forces when driving. Solar panels must be securely attached to the vehicle in accordance with all local and national safety standards. In addition, the solar mount manufacturer's instructions must be adhered to or may be required to be exceeded to comply with local and national standards.

CAUTION

1. Solar products should not be used by persons (including children) with reduced physical, sensory or mental capabilities, or lack of experience and knowledge, unless they are supervised or have been instructed on how to use the appliance by a person responsible for their safety. Children should be supervised to ensure that they do not play with the Solar product.
2. Do NOT use Solar products to charge non-rechargeable batteries. Doing so may result in harm to the user and/or damage to the Solar products.
3. Do NOT exceed the current and voltage rating of the cables and connectors. Exceeding the recommended ratings will cause damage to the components.
4. Incorrect connections can subject the Solar products to high voltages or currents that will cause damage. Ensure the recommended connections and sequences are followed.
5. Only use Solar products for charging Lead Acid, Gel, Calcium content, AGM or Lithium Iron Phosphate batteries using a Solar Regulator/Charger suitable for the Battery's chemistry and nominal voltage.
6. Solar products are not intended to supply power to a low voltage electrical system other than to charge a battery.
7. An unconnected Solar panel exposed to light may generate voltages up to their rated open-circuit voltage on their leads. Completely cover all Solar panels with an opaque material during installation, and when connecting or disconnecting conductors to reduce the chance of an electrical spark.
8. Do not use mirrors or other devices to artificially concentrate sunlight on Solar panels.
9. Solar panels used in series, parallel, or series-parallel shall be positioned to receive identical amounts of light to reduce risk of damage.

WARNING AND SAFETY INSTRUCTIONS

10. Partially shaded or partially obscured Solar panels will have reduced output, and can damage the Solar panels.
11. Solar panels will achieve best results when proper battery maintenance is regularly performed. This includes but is not limited to checking water and specific gravity levels of the battery.

PERSONAL SAFETY PRECAUTIONS:

12. To assist with the safe operation and use of the Solar Product:
 - a. Wear complete eye protection and clothing protection. Avoid touching eyes while working near a battery.
 - b. If battery acid contacts your skin or clothing, remove the affected clothing and wash the affected area of your skin immediately with soap and water. If battery acid enters your eye, immediately flood the eye with running cold water for at least 10 minutes and seek medical assistance immediately.

CONTENTS

REDARC SOLAR CABLES AND VALUE PACK	2
WARNING AND SAFETY INSTRUCTIONS	2
1 SRC0001 — 5m / 16.4ft MC4 TO BARE-WIRE CONNECTOR	4
2 SRC0002 — 10m / 32.8ft MC4 TO BARE-WIRE CONNECTOR	5
3 SRC0003 — 1.5m / 4.9ft MC4 TO BARE-WIRE CONNECTOR	6
4 SRC0006 — 300mm / 11.8" MC4 'Y' CONNECTORS	7
5 SRC0008 — 1.5m / 5ft ANDERSON™ TO ANDERSON™ CABLE	8
6 SRC0009 — 1.5m / 5ft ANDERSON™ TO BATTERY CLIP CABLE	9
7 SRC0010 — 1.5m / 5ft ANDERSON™ TO BATTERY TERMINAL CABLE	10
8 SRC0011 — 280mm / 11" SERIES ANDERSON™ TO ANDERSON™ CONNECTOR	11
9 SRC0012 — 280mm / 11" PARALLEL ANDERSON™ TO ANDERSON™ CONNECTOR	12
10 SRC0016 — 1.5m / 5ft ANDERSON™ TO BARE-WIRE CONNECTOR	13
11 SRC0017 — 1.5m / 5ft ANDERSON™ TO MC4 CONNECTOR	14
12 SRC0018 — 5m / 16.4ft ANDERSON™ TO ANDERSON™ CABLE	15
13 SRC0019 — 10m / 32.8ft ANDERSON™ TO ANDERSON™ CABLE	16
14 SRPA20-VP — VALUE PACK	17
15 SRC0001-CK — MC4 CONNECTOR KIT	17
16 SYSTEM WIRING	18
16.1 Wiring Precautions	18
16.2 Fuse Protection	18

1 SRC0001 — 5m / 16.4ft MC4 TO BARE-WIRE CONNECTOR

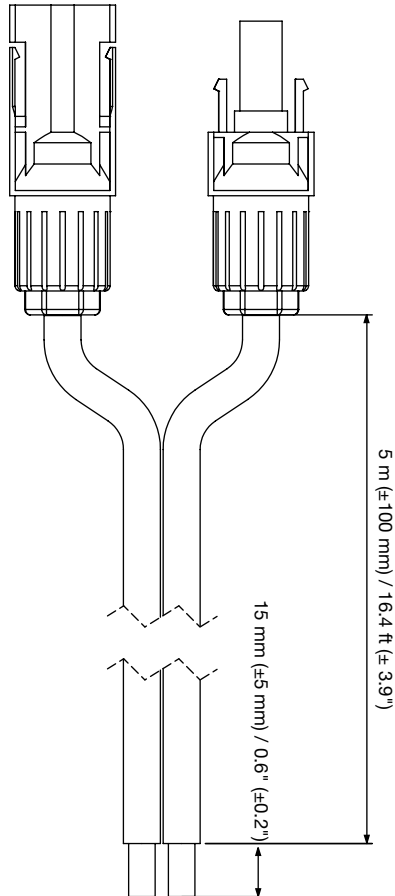

Specifications for MC4 to Bare-Wire Connector

Length	5 m (±100 mm) / 16.4 ft (± 3.9'')	Part Number	SRC0001
		Connector	MC4, bare-wire
Conductor	Tinned Cooper	Current Rating⁽¹⁾	30 A
Conductor size	AWG 11 (Ø2.3 mm)	Voltage Rating	50 VDC max
Insulation/Sheath	UV Stabilised PVC	Colour Coding	Sheath — black
Fuse Type	N/A	Fuse Rating	N/A

(1) Current rating applies when cable is fully extended. Use of cable in coiled state is not recommended.

2 SRC0002 — 10m / 32.8ft MC4 TO BARE-WIRE CONNECTOR

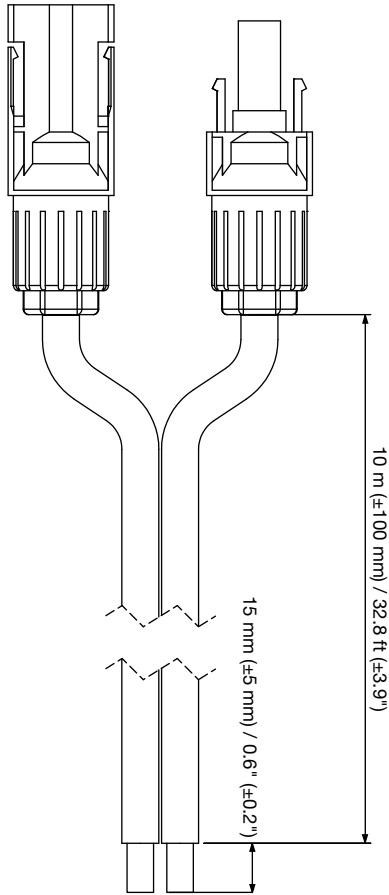

Specification for MC4 to Bare-Wire Connector

Length	10 m (±100 mm) / 32.8 ft (± 3.9'')	Part Number	SRC0002
		Connector	MC4, bare-wire
Conductor	Tinned Cooper	Current Rating⁽¹⁾	30 A
Conductor size	AWG 11 (Ø2.3 mm)	Voltage Rating	50 VDC max
Insulation/Sheath	UV Stabilised PVC	Colour Coding	Sheath — black
Fuse Type	N/A	Fuse Rating	N/A

(1) Current rating applies when cable is fully extended. Use of cable in coiled state is not recommended.

3 SRC0003 — 1.5m / 4.9ft MC4 TO BARE-WIRE CONNECTOR

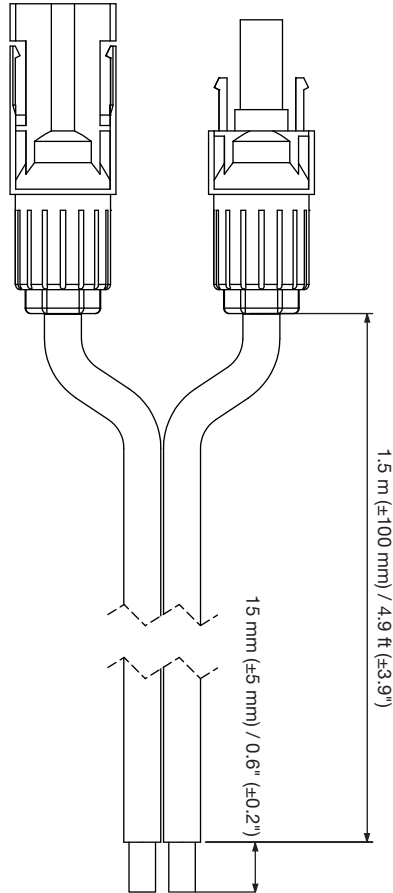

Specifications for MC4 to Bare-Wire Connector

Length	1.5 m (± 100 mm) / 4.9 ft (± 3.9")	Part Number	SRC0003
		Connector	MC4, bare-wire
Conductor	Tinned Cooper	Current Rating⁽¹⁾	30 A
Conductor size	AWG 11 (Ø2.3 mm)	Voltage Rating	50 VDC max
Insulation/Sheath	UV Stabilised PVC	Colour Coding	Sheath — black
Fuse Type	N/A	Fuse Rating	N/A

(1) Current rating applies when cable is fully extended. Use of cable in coiled state is not recommended.

4 SRC0006 — 300mm / 11.8" MC4 'Y' CONNECTORS

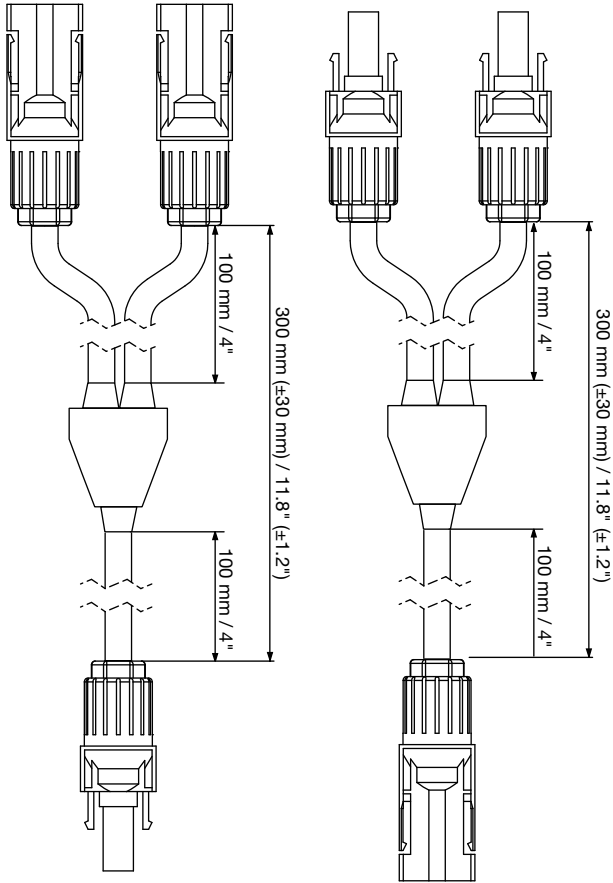

Specifications for MC4 'Y' Connectors

Length	300 mm (±30 mm) / 11.8" (±1.2")	Part Number	SRC0006
		Connectors	MC4 'Y'
Conductor	Tinned Cooper	Current Rating⁽¹⁾	30 A
Conductor size	AWG 11 (Ø2.3 mm)	Voltage Rating	50 VDC max
Insulation/Sheath	UV Stabilised PVC	Colour Coding	Sheath — black
Fuse Type	N/A	Fuse Rating	N/A

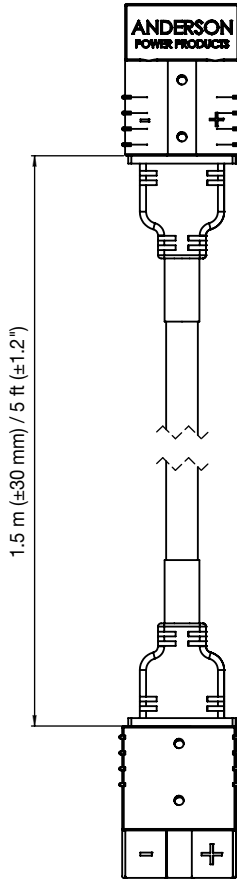

Specifications for Anderson™ to Anderson™ Cable

Length	1.5 m (± 30 mm) / 5 ft (± 1.2'')	Part Number	SRC0008
		Connector	Anderson™ SB™ 50
Conductor	Bare Copper	Current Rating⁽¹⁾	50 A
Conductor size	AWG 11 (Ø2.3 mm)	Voltage Rating	50 VDC max
Insulation/Sheath	UV Stabilised PVC	Colour Coding	Positive lead — red Negative lead — black Sheath — black
		Fuse Type	N/A
		Fuse Rating	N/A

(1) Current rating applies when cable is fully extended. Use of cable in coiled state is not recommended.

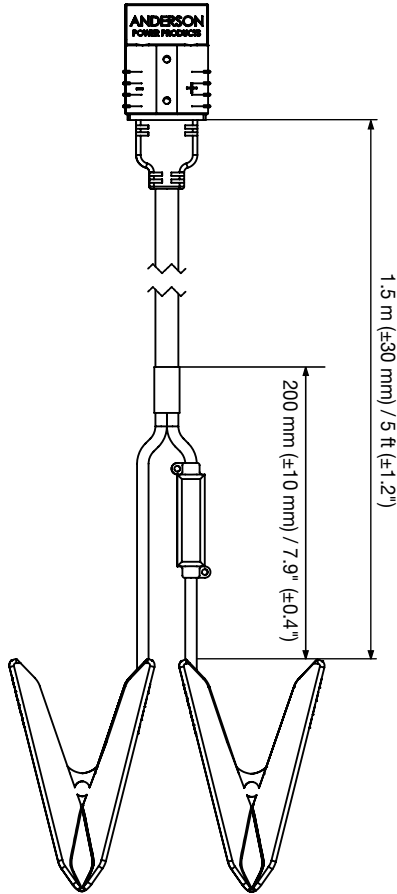

Specifications for Anderson™ to Battery Clip Cable

Length	1.5 m (± 30 mm) / 5 ft (± 1.2")	Part Number	SRC0009
		Connector	Anderson™ SB™ 50, battery clip
Conductor	Bare Copper	Current Rating⁽¹⁾	30 A
Conductor size	AWG 11 (Ø2.3 mm)	Voltage Rating	50 VDC max
Insulation/Sheath	UV Stabilised PVC	Colour Coding	Positive lead — red Negative lead — black Sheath — black
		Fuse Type	MIDI
		Fuse Rating	40 A

(1) Current rating applies when cable is fully extended. Use of cable in coiled state is not recommended.

7 SRC0010 — 1.5m / 5ft ANDERSON™ TO BATTERY TERMINAL CABLE

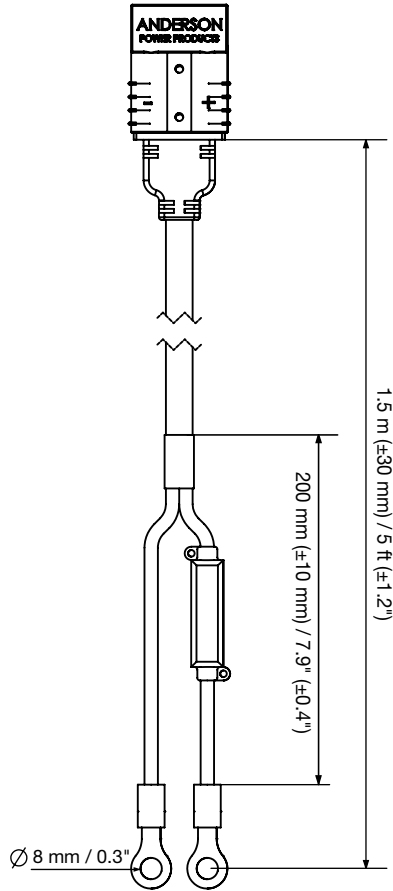

Specifications for Anderson™ to Battery Terminal Cable

Length	1.5 m (± 30 mm) / 5 ft (± 1.2")	Part Number	SRC0010
		Connector	Anderson™ SB™ 50, battery terminal
Conductor	Bare Copper	Current Rating ⁽¹⁾	30 A
Conductor size	AWG 6 (Ø4.1 mm)	Voltage Rating	50 VDC max
Insulation/Sheath	UV Stabilised PVC	Colour Coding	Positive lead — red
			Negative lead — black
Fuse Type	MIDI	Fuse Rating	40 A

(1) Current rating applies when cable is fully extended. Use of cable in coiled state is not recommended.

8 SRC0011 — 300mm / 1ft SERIES ANDERSON™ TO ANDERSON™ CONNECTOR

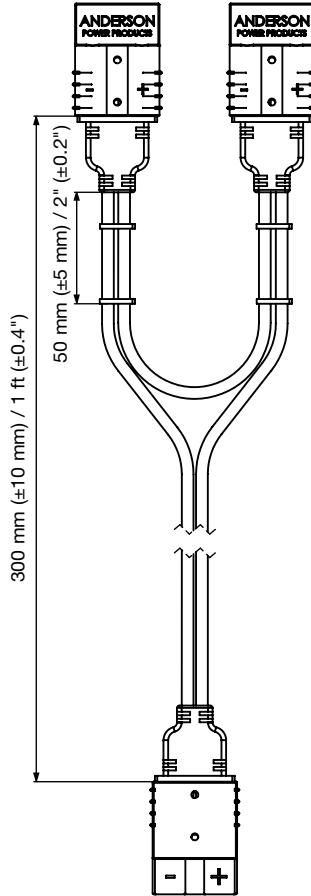

Specifications for Series Anderson™ to Anderson™ Connector

Length	300 mm (± 10 mm) / 1 ft (± 0.4 ")	Part Number	SRC0011
		Connector	Anderson™ SB™ 50
Conductor	Bare Copper	Current Rating	40 A
Conductor size	AWG 11 (Ø2.3 mm)	Voltage Rating	50 VDC max
Insulation/Sheath	UV Stabilised PVC	Colour Coding	Positive lead — red Negative lead — black Sheath — black
		Fuse Type	N/A
Fuse Rating	N/A	Fuse Rating	N/A

9 SRC0012 — 300mm / 1ft PARALLEL ANDERSON™ TO ANDERSON™ CONNECTOR

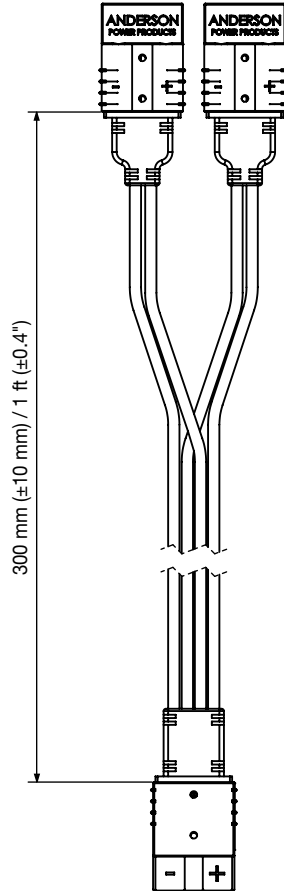

Specifications for Parallel Anderson™ to Anderson™ Connector

Length	300 mm (± 10 mm) / 1 ft (± 0.4 ")	Part Number	SRC0012
		Connector	Anderson™ SB™ 50
Conductor	Bare Copper	Current Rating	40 A
Conductor size	AWG 11 (Ø2.3 mm)	Voltage Rating	50 VDC max
Insulation/Sheath	UV Stabilised PVC	Colour Coding	Positive lead — red
			Negative lead — black
			Sheath — black
Fuse Type	N/A	Fuse Rating	N/A

10 SRC0016 — 1.5m / 5ft ANDERSON™ TO BARE-WIRE CONNECTOR

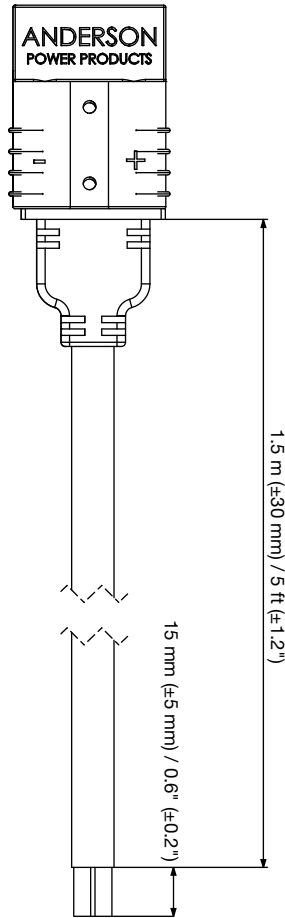

Specifications for Anderson™ to Bare-Wire Connector

Length	1.5 m (± 30 mm) / 5 ft (± 1.2'')	Part Number	SRC0016
		Connector	Anderson™ SB™ 50, bare-wire
Conductor	Bare Copper	Current Rating⁽¹⁾	40 A
Conductor size	AWG 10 (Ø2.6 mm)	Voltage Rating	50 VDC max
Insulation/Sheath	UV Stabilised PVC	Colour Coding	Positive lead — red
			Negative lead — black
Fuse Type	N/A	Fuse Rating	N/A
			Sheath — black

(1) Current rating applies when cable is fully extended. Use of cable in coiled state is not recommended.

11 SRC0017 — 1.5m / 5ft ANDERSON™ TO MC4 CONNECTOR

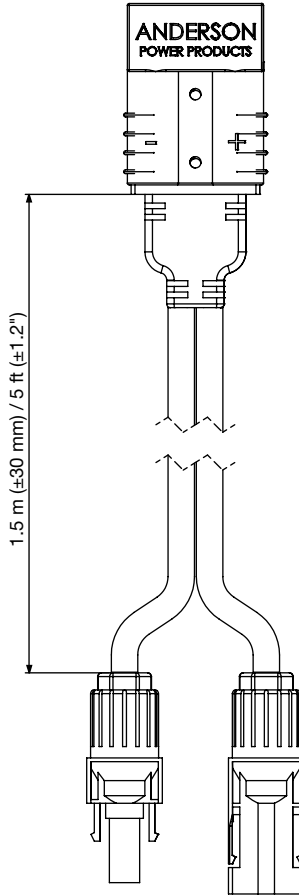

Specifications for Anderson™ to MC4 Connector

Length	1.5 m (±30 mm) / 5 ft (± 1.2'')	Part Number	SRC0017
		Connector	Anderson™ SB™ 50, MC4
Conductor	Bare Copper	Current Rating⁽¹⁾	30 A
Conductor size	AWG 10 (Ø2.6 mm)	Voltage Rating	50 VDC max
Insulation/Sheath	UV Stabilised PVC	Colour Coding	Sheath — black
Fuse Type	N/A	Fuse Rating	N/A

(1) Current rating applies when cable is fully extended. Use of cable in coiled state is not recommended.

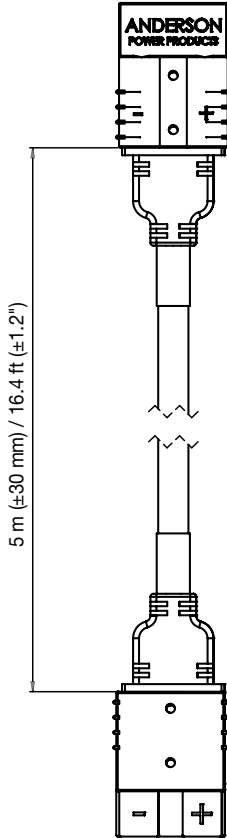

Specifications for Anderson™ to Anderson™ Cable

Length	5 m (± 30 mm) / 16.4 ft (± 1.2")	Part Number	SRC0018
		Connector	Anderson™ SB™ 50
Conductor	Bare Copper	Current Rating⁽¹⁾	40 A
Conductor size	AWG 10 (Ø2.6 mm)	Voltage Rating	50 VDC max
Insulation/Sheath	UV Stabilised PVC	Colour Coding	Positive — red Negative — black Sheath — black
Fuse Type	N/A	Fuse Rating	N/A

(1) Current rating applies when cable is fully extended. Use of cable in coiled state is not recommended.

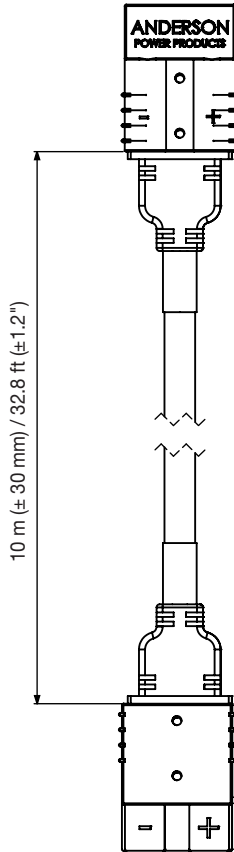

Specifications for Anderson™ to Anderson™ Cable

Length	10 m (± 30 mm) / 32.8 ft (± 1.2'')	Connector	Anderson™ SB™ 50
Conductor	Bare Copper	Current Rating⁽¹⁾	30 A
Conductor size	AWG 10 (Ø2.6 mm)	Voltage Rating	50 VDC max
Insulation/Sheath	UV Stabilised PVC	Colour Coding	Positive — red Negative — black Sheath — black
Fuse Type	N/A	Fuse Rating	N/A

(1) Current rating applies when cable is fully extended. Use of cable in coiled state is not recommended.

14 SRPA20-VP — VALUE PACK

The SRPA20-VP offers a complete regulator and cable kit for a portable setup. The Anderson™ SB™50 connectors allow for simple plug and play set up of the system. The included cables allow the panels to be positioned up to 5 m from the regulator

Value Pack Contents

1. SRPA0240 — 20 A Solar Regulator
2. SRC0018 — 5 m Anderson™ to Anderson™ cable
3. SRC0009 — 1.5 m Anderson™ to battery clip cable

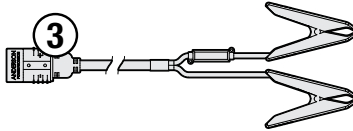
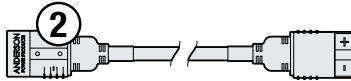
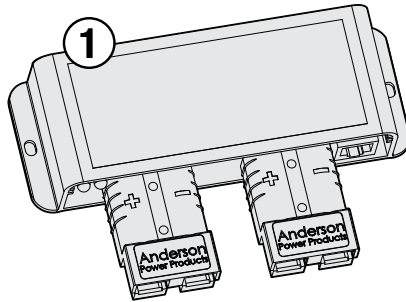

15 SRC0001-CK — MC4 CONNECTOR KIT

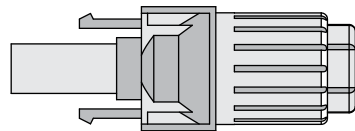
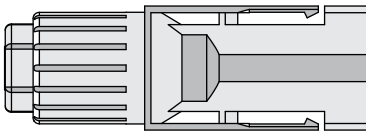

The SRC001-CK includes a male and female MC4 connector.

16.1 Wiring Precautions

- Ensure that all connections are made using REDARC recommended connectors and cables or other suitably rated connectors and cables.
- Ensure that the maximum system current does not exceed the current rating of the cables.
- Ensure that grounding and fusing is adequate and sound for the system.
- Ensure that all additional and or non-REDARC Anderson™ plug terminals are soldered correctly or crimped with the correct Anderson™ crimping tool.
- All cable entries into the vehicle or trailer must be suitably sealed.
- If the regulator has a dedicated Solar input ground (negative) terminal, ensure that the negative ground from the Solar Panels is connected directly to the regulator. Refer to the manufacturer's instructions.
- The SRC0009 Battery clip cable is intended for a portable short term connection, and is not to be left connected permanently.

16.2 Fuse Protection

Fuse protection is required for wire and component protection in case of short circuit. Fuses must be fitted as close as possible to the battery positive terminal.

REDARC recommend using MIDI style bolt down fuses as they ensure a low resistance connection. The REDARC FK40 and FK60 fuse kits are recommended.

Blade type fuses are not recommended as they can result in high resistance connection which causes excess heat and may damage the fuse holder and/or the wiring.

Self-resetting circuit breakers are not recommended as they may trip prematurely due to the heat generated by the current flowing through the wires.

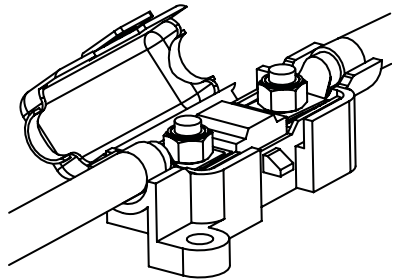
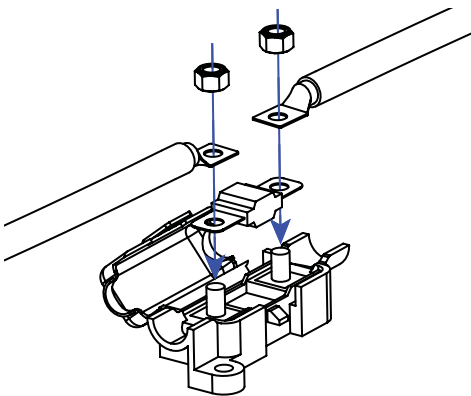

WARRANTY

Limited Warranty

For full warranty terms and conditions, visit the link below or refer to the contact details applicable to your region.

Australia, New Zealand

www.redarc.com.au/warranty

REDARC Electronics Pty Ltd
23 Brodie Road (North),
Lonsdale SA 5160
Australia

Australia	1300 REDARC (1300 733 272)
New Zealand	+64 9 222 1024
UK and Europe	+44 (0)20 3930 8109

North America

www.redarcelectronics.com/warranty

REDARC Corporation
c/o Shallco, Inc.
308 Component Dr.
Smithfield, NC 27577
USA

USA	+1 (704) 247 5150
Canada	+1 (604) 260 5512
Mexico	+52 (558) 526 2898

FREE TECHNICAL ASSISTANCE

For product and technical support contact your regional distributor, call our head office between 8:00 a.m. to 5:30 p.m. Australian Central Standard Time, Monday to Friday, or send us an e-mail.

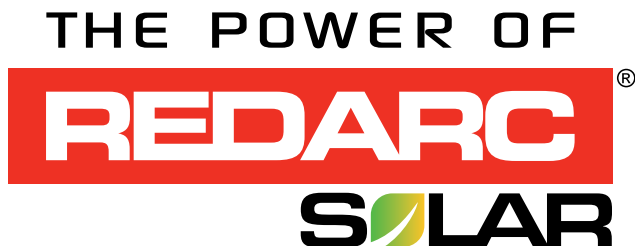

Australia (and other Global regions)

power@redarc.com.au
www.redarc.com.au
1300 REDARC (1300 733 272)

New Zealand

power@redarcelectronics.co.nz
www.redarcelectronics.co.nz
+64 9 222 1024

North America

power@redarcelectronics.com
www.redarcelectronics.com

United States

+1 (704) 247-5150

Canada

+1 (604) 260-5512

Mexico

+52 (558) 526-2898

UK/Europe

power@redarcelectronics.eu
www.redarcelectronics.eu
+44 (0)20 3930 8109

www.redarc.com.au