



Brilliant Aiming Solutions™

Trijicon, Inc.
 P.O. Box 930059
 49385 Shafer Ave.
 Wixom, MI 48393

(248) 960-7700
 Fax: (248) 960-7725
 info@trijicon.com
 www.trijicon.com

©2009 Trijicon, Inc. | Printed in U.S.A. | MANUAL-BAC | 0510

Operator's Manual:

Trijicon® ACOG® (Advanced Combat Optical Gunsight)



BAC Models

- ▼ 3.5x35
- ▼ 4x32



Brilliant Aiming Solutions™



Operator's Manual:
Trijicon ACOG[®] (Advanced Combat Optical Gunsight)



BAC Models

- ▼ 3.5x35
- ▼ 4x32



Brilliant Aiming Solutions™

TABLE OF CONTENTS

	Page
Warnings and Cautions	3
Introduction.....	5
Characteristics	6
Controls and Indicators	7
Identification.....	8
Preparation for Use	10
Installation Procedures.....	12
Adjustment Procedures.....	19
Reticle References	23
Chevron Reticle.....	23
Donut Reticle.....	26
Triangle Reticle.....	29
Horseshoe Reticle	32
Circle Chevron Reticle	35
Operation	37
Safety.....	40
Cleaning and General Care	42
Troubleshooting	45
3.5 and 4x32 BAC ACOG® Models & Available Accessories.....	46
Patents and Trademarks.....	50
Limited Lifetime Warranty	51

WARNINGS AND CAUTIONS

Warning

Before installing optic on a weapon, ensure the firearm is CLEAR. Remove the magazine, pull the charging handle to the rear and ensure the chamber is clear.

☠️ RADIOACTIVE MATERIALS SAFETY PRECAUTIONS ☠️

BAC ACOG®s contain radioactive material for nighttime illumination. The radiation source is Hydrogen-3 (^3H), commonly known as tritium. Tritium is an odorless, tasteless, colorless gas that reacts to the human body in the same manner as natural hydrogen. The human body does not easily retain hydrogen or Tritium as a gas. However, the oxide, HTO, which is formed by the burning of Tritium, is 10,000 times more hazardous. For this reason great care should be taken to avoid flame in the presence of the ACOG® with a Tritium lamp which is broken or is suspected of leaking. If the Tritium lamp in the ACOG® scope breaks follow the procedures on the following page. The ACOG® is regulated under an EXEMPT LICENSE from the United States Nuclear Regulatory Commission (NRC) held by Trijicon, Inc. Disassembly of the scope is prohibited except by Trijicon, Inc.

Handling a Damaged ACOG® (exposed internals, fire, or crushed)

DO NOT handle a defective unit if you have open skin cuts or abrasions (use gloves). If the Tritium lamp in an ACOG® is broken or suspected of being broken, work in a well ventilated area and avoid inhaling air near the unit. Place the unit in a sealed plastic bag and contact Trijicon for return and proper disposal. Immediately following contact with the unit wash your hands with soap and water.

DO NOT eat, drink, smoke, or apply cosmetics in the presence of a damaged ACOG®.

CAUTION

DO NOT allow fiber optic collector to contact harsh chemicals.

INTRODUCTION

The Advanced Combat Optical Gunsight (ACOG®) with our dual-illumination technology features a unique combination of advanced fiber optics and self-luminous tritium. This dual-illumination technology, originally developed for the military and proven in combat, allows the aiming point to be always illuminated. Tritium illuminates the aiming point in total darkness, while the fiber-optic light collector adjusts reticle brightness according to light levels. This automatically balances aiming point brightness with shooting conditions allowing the Bindon Aiming Concept (BAC) to function. The 3.5x35 and 4x32 BAC models are designed to provide enhanced target identification and hit probability for the M16 and AR-15 rifle out to 800 meters.

CHARACTERISTICS

Descriptive Power/ Objective Lens	Eye Relief	Exit Pupil	Field of View	Length	Weight w/out Mount	Field of View @ 100 Yards	Adjustment Increments @ 100 yards (Internal Adjusters)
3.5x35	2.4 in (61 mm)	.39 in (10 mm)	5.5°	8 in (203 mm)	14 oz (397 g)	28.9 ft (9.69 m)	3 clicks (4 clicks)
4x32	1.5 in (38 mm)	.32 in (8 mm)	7.0°	5.8 in (147 mm)	9.9 oz (10.9 g)	36.8 ft (12.29 m)	2 clicks (3 clicks)

CONTROLS AND INDICATORS



Figure 1

IDENTIFICATION & MARKINGS

External Markings

Figure 2 identifies where the serial number for all 3.5x35 and 4x32 ACOG®'s can be found. This number is unique for each ACOG® sold.



Figure 2

Internal Markings

Figure 3 illustrates how to identify the reticle. Each model ACOG® has a reticle code. This code is found at the bottom of the field of view when looking into the optic.

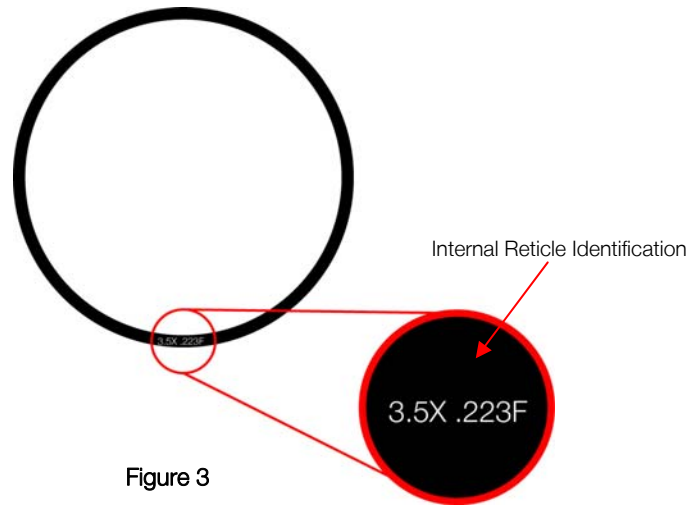

Figure 3

PREPARATION FOR USE

Inspection

It is recommended that the tritium lamp be checked prior to the use of the optic and every six months or immediately following any incident which might lead to lamp failure such as the dropping of the ACOG® onto a hard surface.

To determine that the tritium lamp is functioning in the ACOG®, enter a dark room and look through the optic. The reticle should be illuminated red, amber or green as shown in **Figure 4** on page 11. The illumination provided by the tritium lamp is very faint and will be hard to see without a dark adapted eye. Remain in the dark room for approximately 10 minutes to adapt your eyes to the dark.

The reticle is illuminated in low light or complete darkness. If the reticle does not appear to illuminate in the dark, please contact TRIJICON, INC. See further cautions under **SAFETY** on page 40.

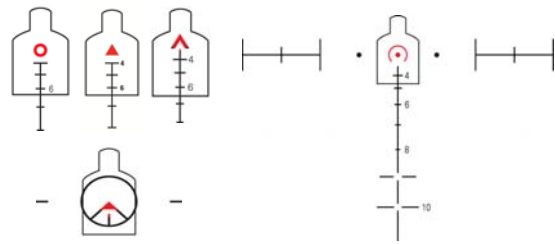

3.5x35

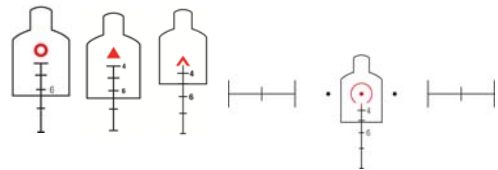

4x32

Figure 4
(Other colors available)

INSTALLATION PROCEDURES

WARNING:

Before installing the optic on a firearm, ensure the weapon is CLEAR. Remove the magazine, pull the charging handle to the rear and ensure the chamber is clear.

Flattop Version

The BAC ACOG® with flat top adapter is easily attached to the M4 flattop receiver MIL-STD-1913 Rail. Prior to attempting to mount the optic, loosen the Thumb Screws and pull the Interface Clamp Bar back against the Thumb Screws as illustrated in **Figure 5**. Place the ACOG® onto the flattop receiver rail.

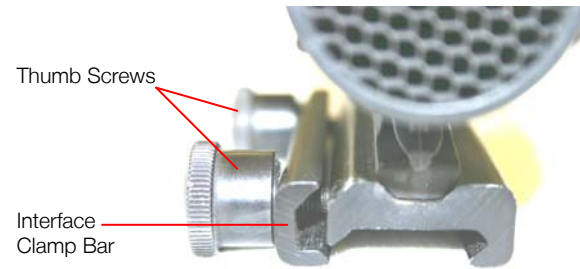

Figure 5

Be sure to align the Interface Studs located on the bottom of the adapter with the grooves on the MIL-STD-1913 Rail of the flattop receiver as illustrated in **Figure 6**.

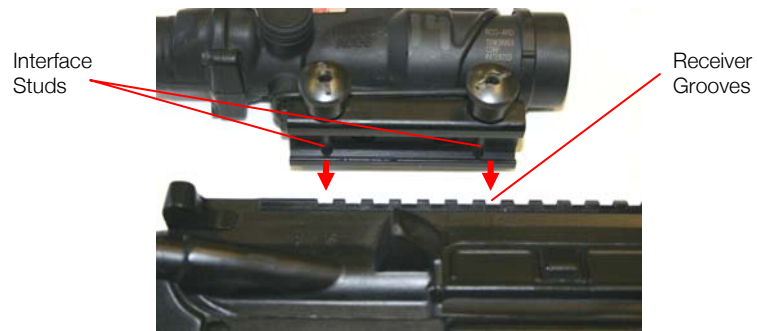

Figure 6

The BAC ACOG® can be placed in any of the slots on top of the receiver to allow for eye relief adjustment. Once the ideal position has been determined, apply forward pressure on the optic and tighten the knobs firmly using finger pressure only. Then, add no more than another ¼ turn utilizing a coin or a bladed screwdriver. This will ensure the mount will not loosen under recoil.

Installing the ACOG® in the same position on the flattop rail and using the same torque on the Thumb Screws will ensure maximum zero retention. To replicate the same torque setting, tighten using the recommended method and mark the Thumb Screws and Interface Bar Clamp (**Figure 7**) with indelible marker or other semi permanent means.



Figure 7

Adapter Disassembly

The TA51 mount is removed by removing the two screws from the underside of the mount as identified in **Figure 8**. The screws have a thread locking compound applied to them by the manufacturer.



Figure 8

NOTE: Use a 1/4 inch flat tip screwdriver to remove the screws.

Carry Handle Versions

The ACOG® is easily attached to the M16 and AR-15 carrying handle. One screw set is provided with your scope. The forward screw hole is toward the objective lens and is provided with a specially shaped washer to fit the inside surface of the M16/AR-15 carrying handle. The forward screw hole should be aligned with the existing hole in your weapon's handle. The specially shaped washer matches the curved surface of the handle and assures a tight clamping that will not work loose. As an accessory, Trijicon, Inc. offers a thumb screw for quick release from the carry handle.



Figure 9

Installation Procedure - M16/AR-15 with Carrying Handle

The special washer should be placed on the screw after the lock washer so that the U shape fits under the handle against the curved surface. Using the provided hex key, the screws should be tightened snugly, but not over tightened.

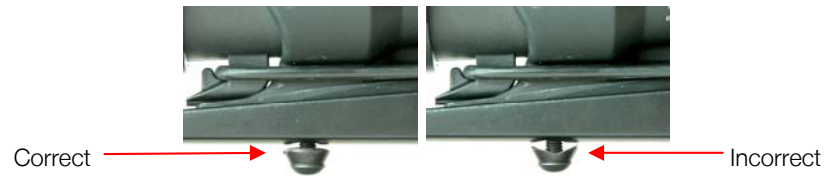

Figure 10

The mounting foot has a special hole through the base that allows the original iron sights to be used in an emergency.

NOTE: Use caution on some older AR-15 and M16A1 rifles. The flip up rear aperture sight must be in the "leaf toward the shooter's eye" position. If it is in the opposite position, it will be trapped under the rear edge of the ACOG® base. This is less secure and puts the scope at an angle, which makes it impossible to zero the weapon.

Installation on Other Firearms

Trijicon offers a variety of adapters for various firearms (see page 46).

ADJUSTMENT PROCEDURES

CAUTION

The windage and elevation adjusters should never be moved all the way to the extremes in adjustment. It is possible that over-adjustment will damage the precise alignment of the prism assembly inside the riflescope. If the adjuster resistance increases, the limits of adjustment travel are being approached. Adjust further only with caution.

As the limits of the adjustment are reached, the adjustment mechanism will become more and more difficult to adjust. If the adjustment mechanism is adjusted past this point, it will break. Adjustment beyond the center of the adjustment range should not be necessary. If it seems that you need more adjustment than is available, please contact Trijicon, Inc.

The ACOG[®] is internally adjustable. Adjustment is made using the adjuster mechanisms located inside the adjuster caps on the top and right-hand side of the scope. The ACOG[®] is shipped with a pre-centered setting. Normally this means that only small adjustments are necessary. Do not adjust the scope to the extremes. It is possi-

ble that over-adjustment will damage the precise alignment of the prism assembly inside the riflescope (see **CAUTION** above).

The method of adjustment with the ACOG® 4x32 is slightly different than other scopes. Adjustment increments are 1/2 inch per click at 100 yards. This means that 2 clicks (3 clicks internal adjuster) are required to move the bullet one inch on the target.

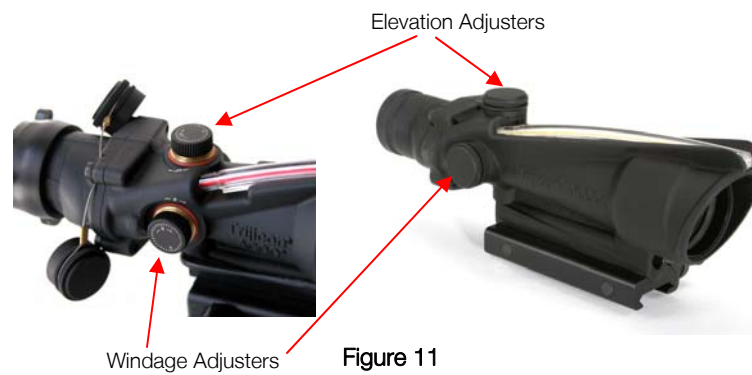

Figure 11

Adjustment increments with the ACOG® 3.5x35 are 1/3 inch per click at 100 yards. This means that 3 clicks (4 clicks internal adjusters) are required to move the bullet one inch on the target.

To make adjustments remove the adapter cap. The arrows on the adjusters point in the direction which they must be moved to cause the bullet to move in that same direction. In other words, if the point of impact is two inches to the left of the aiming point, the adjuster on the side of the 4x32 riflescope should be moved 4 clicks in the direction marked R (right) while the adjuster on the side of the 3.5x35 riflescope should be moved 6 clicks in the direction marked R (right). This will move the bullet 2 inches to the right and onto target. Similarly, if the bullet is striking low on the target, you must move the adjuster on the top of the riflescope in the direction U (up). [Of course if the bullet is right or high of center, the adjusters must be turned the other directions, away from the R and U directions indicated.] The amount of clicks can be detected through audible and physical feedback.



Figure 12



Figure 13

For carry handle models the units come centered for mounting in the carry handle. The flattop versions will be centered for using on the flattop rail. Normally this means that only small adjustments are necessary.

Adjuster Caps

The adjuster caps, identified in **Figure 14**, are designed for added protection of the adjusters. It is recommended that the adjuster caps be reinstalled after every adjustment. The caps must be tightened until the adjuster cap makes contact with the main housing. This should be accomplished with fingers only. This will prevent possible damage to the cap or the adjuster housing threads. No use of tools is required to tighten the caps.

CAUTION: Damage may occur to the cap or the threads of the adjuster housing if the cap does not make contact with the main housing when the cap is exposed to impact.

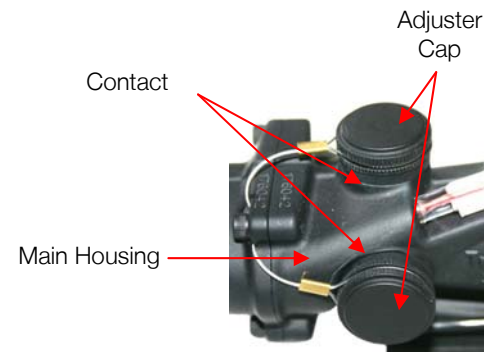

Figure 14

RETICLE REFERENCES

The Bullet Drop Compensator (BDC)

The entire reticle pattern is a Bullet Drop Compensator, designed to compensate for the trajectory of the 5.56mm, 6.8 mm or 7.62 mm round (depending on the model) from 100-800 meters without making mechanical adjustments to the sight. When zeroed properly, the Point of Aim/Point of Impact at the designated distance is shown in **Figure 15**.

Chevron Reticle

To zero the BAC ACOG® at 100 meters use the tip of the illuminated reticle to acquire Point of Aim/Point of Impact (**Figure 15**). This method ensures maximum accuracy to 800 meters utilizing the Bullet Drop Compensator. Follow the Adjustment Procedure to move Point of Impact.

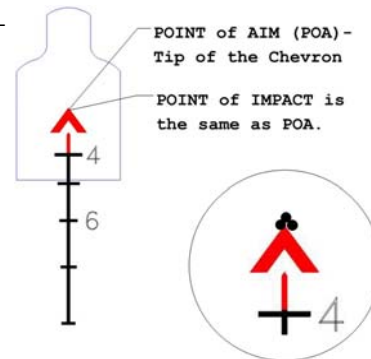

Figure 15

Ranging Feature

The base of the reticle and the horizontal stadia lines represent 19" at the indicated range (19" is the average width of a man's shoulders). Range your target using the base of the chevron for 300m and the width of the horizontal stadia lines for 400-800m as identified in **Figure 16**.

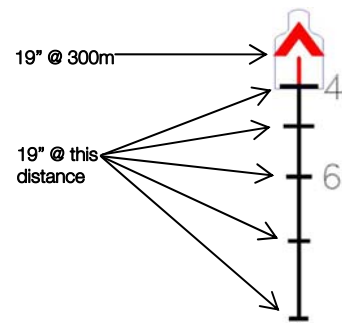

Figure 16

Beyond 300m, determine which stadia line best fits the target's shoulders and use that 'crosshair' as your Point of Aim. Because the BDC is calibrated for the correct trajectory, your Point of Aim is your Point of Impact at each distance. **Figure 17** illustrates proper sight picture at each distance.

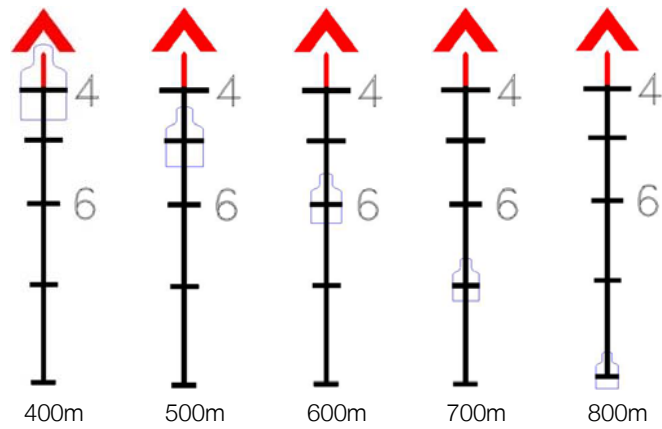

Figure 17

Donut Reticle

To zero the BAC ACOG® at 100 meters use the top of the illuminated reticle to acquire Point of Aim/Point of Impact (**Figure 18**). This method ensures maximum accuracy to 800 meters utilizing the Bullet Drop Compensator. Follow the Adjustment Procedure to move Point of Impact.

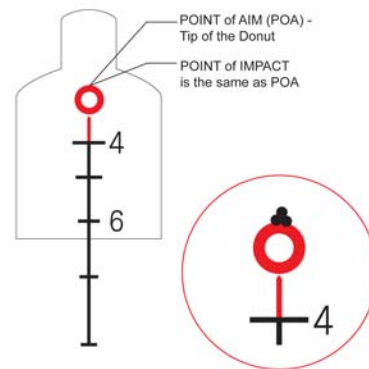

Figure 18

Ranging Feature

The horizontal stadia lines below the reticle represent 19" at the indicated range (19" is the average width of a man's shoulders). Range your target for 300m and the width of the horizontal stadia lines for 400-800m as identified in **Figure 19**.

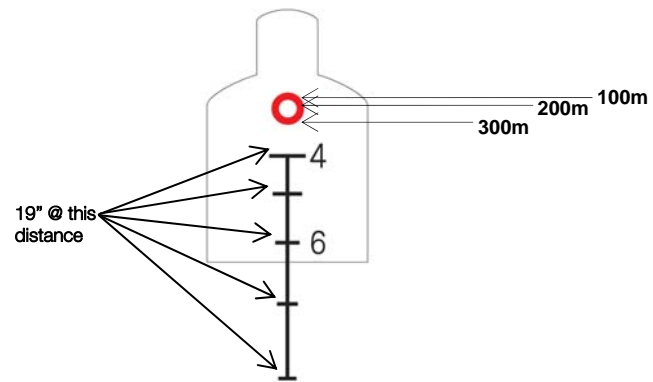

Figure 19

Beyond 300m, determine which stadia line best fits the target's shoulders and use that 'crosshair' as your Point of Aim. Because the BDC is calibrated for the correct trajectory, your Point of Aim is your Point of Impact at each distance. **Figure 20** illustrates proper sight picture at each distance.

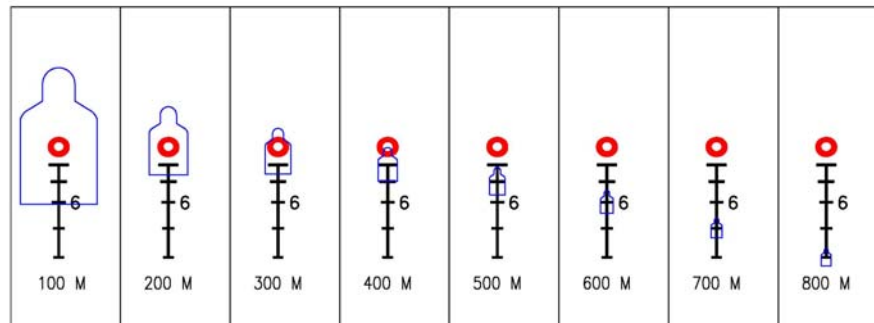

Figure 20

Triangle Reticle

To zero the BAC ACOG® at 100 meters use the tip of the illuminated reticle to acquire Point of Aim/Point of Impact (**Figure 21**). This method ensures maximum accuracy to 800 meters utilizing the Bullet Drop Compensator. Follow the Adjustment Procedure to move Point of Impact.

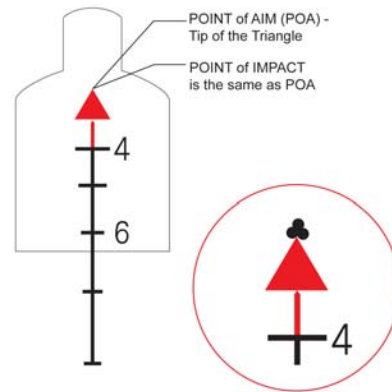

Figure 21

Ranging Feature

The base of the reticle and the horizontal stadia lines represent 19" at the indicated range (19" is the average width of a man's shoulders). Range your target using the base of the triangle for 300m and the width of the horizontal stadia lines for 400-800m as identified in **Figure 22**.

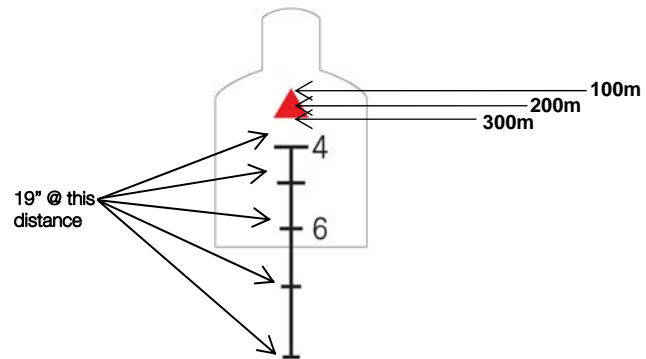

Figure 22

Beyond 300m, determine which stadia line best fits the target's shoulders and use that 'crosshair' as your Point of Aim. Because the BDC is calibrated for the correct trajectory, your Point of Aim is your Point of Impact at each distance. **Figure 23** illustrates proper sight picture at each distance.

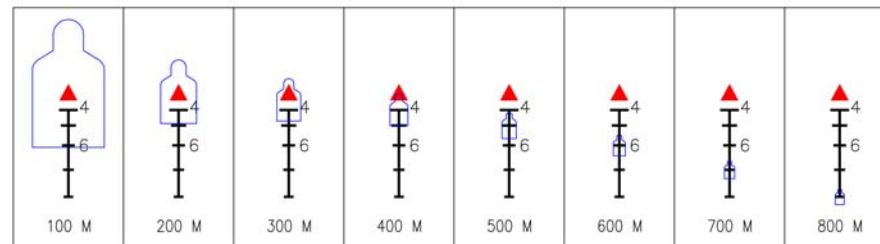

Figure 23

Horseshoe Reticle

To zero the BAC ACOG® at 100 meters use the center dot of the illuminated reticle to acquire Point of Aim/Point of Impact (Figure 24). This method ensures maximum accuracy to 800 meters utilizing the Bullet Drop Compensator. Follow the Adjustment Procedure to move Point of Impact.

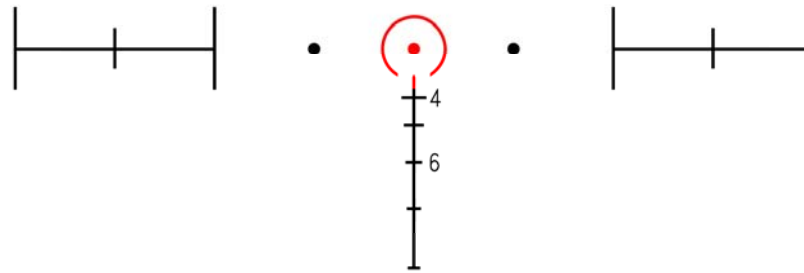

Figure 24

Ranging Feature

The opening at the base of the horseshoe and the horizontal stadia lines below the reticle represent 19" at the indicated range (19" is the average width of a man's shoulders). Range your target using the base of the horseshoe for 300m and the width of the horizontal stadia lines for 400-800m as identified in **Figure 25**.

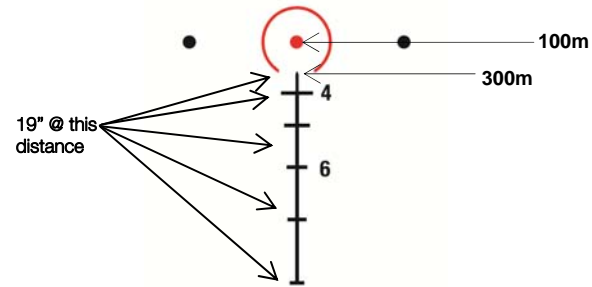

Figure 25

Beyond 300m, determine which stadia line best fits the target's shoulders and use that 'crosshair' as your Point of Aim. Because the BDC is calibrated for the correct trajectory, your Point of Aim is your Point of Impact at each distance. **Figure 26** illustrates proper sight picture at each distance.

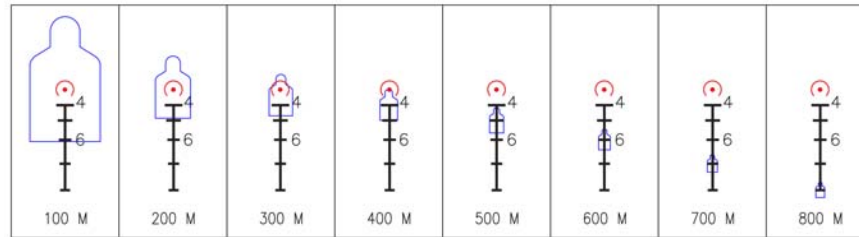

Figure 26

Circle Chevron Reticle

To zero the BAC ACOG® at 100 meters use the top of the illuminated reticle to acquire Point of Aim/Point of Impact (Figure 27). This method ensures maximum accuracy to 800 meters utilizing the Bullet Drop Compensator. Follow the Adjustment Procedure to move Point of Impact.

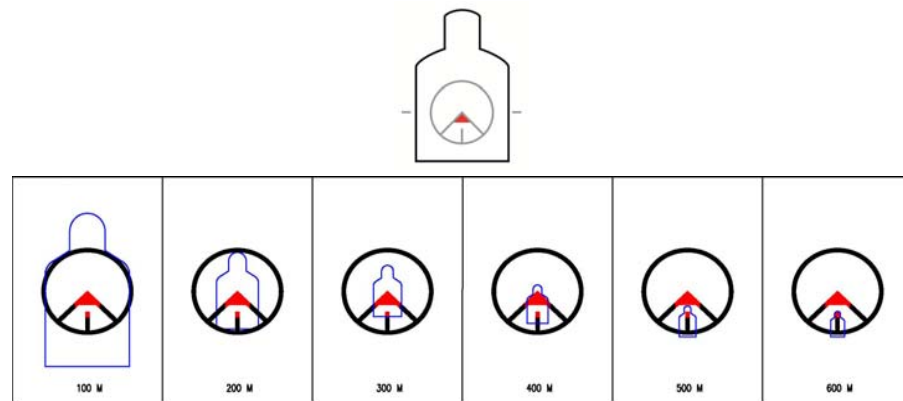

Figure 27

BAC ACOG® Target Reference System

Some BAC ACOG® reticles include a horizontal mil-scale graduated in 5 mil increments. The distance from the center post to the first mil bar is 10 mils left side and 10 mils right side.

NOTE: Due to the design of the optic, the right side of the mil scale will become blurry. This is normal.

The horizontal mil scale is primarily used as a target referencing system. It provides an actual horizontal measurement for a shooter to identify and accurately relay the position of another target to others around. This is a very useful tool for Military and Law Enforcement teams who rely on quick target acquisition for the success of their missions.

OPERATION

Quick Target Acquisition

The BAC ACOG[®] is designed to be utilized with BOTH eyes OPEN for targets from muzzle to 300 meters, providing quick target acquisition and engagement when needed. This allows the scope to be utilized as a reflexive sight when speed is critical. Train yourself to:

- ▼ Keep BOTH eyes OPEN
- ▼ Focus on the target
- ▼ Bring the weapon/optic up into your line of sight—DO NOT switch focus to the reticle

At extreme close ranges, where time is critical to survival, keep BOTH eyes OPEN, put color reticle on target, and engage. Do not take the time to obtain a full field of view, center the reticle, or identify the shape of the reticle. Simply put color on target and squeeze the trigger. At this speed no magnification is noticed until after firing.

As the distance between you and the target increases, so should the time taken to engage more accurately. The Both Eyes Open shooting technique can be used very

effectively from muzzle to 300 meters when needed (immediate threat). This is why the reticle is illuminated to 300 meters.

The Bindon Aiming Concept (BAC)

The BAC feature allows the shooter to track and engage moving targets quickly.

Utilizing the Both Eyes Open aiming method, when the weapon is being moved, the image as seen through the ACOG® with your shooting eye blurs much quicker than the view from your non-shooting eye (because it is magnified 4x). The brain chooses the non-blurry view from the non-shooting eye automatically (switches focus). As soon as you are close to the proper aim on target, weapon movement slows, the blur ceases, and your brain instantly selects the greater detail of the magnified view.

This means when the weapon is moving to the target you will not notice any magnification. All you will see is the illuminated chevron in the target area, like a reflexive sight. Once you slow the weapon on the target, the target will 'Zoom' in at 4x, allowing you to identify and engage more accurately if necessary.

This aiming concept happens naturally (without conscious thought) for those with equal or close to equal vision in both eyes. It takes practice keeping BOTH eyes OPEN and focusing on your target.

Determining Your Dominant Eye

To maximize the ACOG[®]'s potential (shooting with both eyes open), you must know which eye is dominant. To determine this, conduct the following test:

1. With BOTH eyes OPEN, hold your index finger out in front of your line of sight.
2. Pick up an aiming point and keep your index finger on it.
3. Close your non-shooting eye. If your index finger/aiming point moves, you are cross eye dominant.

To use any aiming device to its full potential you must use your dominant eye to aim. This may mean learning to shoot from your opposite side. If you are cross-eye dominant (shooting with your weak eye), there will be a shift in your Point of Impact ranging from slight to major dependent upon the disparity between your eyes.

If you choose to aim with your non-dominant eye, it is recommended that you keep your non-shooting eye closed (or occluded) and use the ACOG[®] like a traditional rifle scope. This method is going to be slower at close ranges, but there will be no shift in impact.

SAFETY

The ACOG[®] scope contains radioactive material for nighttime illumination. The radiation source is Hydrogen-3 (³H), commonly known as tritium. Tritium is a naturally occurring, odorless, tasteless, colorless gas that reacts with the human body in the same manner as natural hydrogen. The body does not easily retain hydrogen or tritium as a gas. However, the oxide, HTO, which is formed by the burning of tritium, is 10,000 times more hazardous. For this reason great care should be taken to avoid flame in the presence of the ACOG[®] scope with a tritium lamp which is broken or is suspected of leaking.

If the tritium lamp in the ACOG[®] is broken or is suspected of being broken, place the unit in a sealed plastic bag and contact Trijicon, Inc. for handling and replacement instructions.

After contact with a unit with a broken lamp, a person should wash their hands carefully with soap and water. Do not handle such a defective ACOG[®] scope if you have open skin cuts or abrasions. Work with a defective unit only in a well-ventilated area and avoid inhaling air near the unit.

Do not eat, drink, smoke or apply cosmetics in the presence of a defective unit. Repair of these defective units is only authorized by the manufacturer, Trijicon, Inc. Contact Trijicon, Inc. for handling and replacement instructions.

CLEANING AND GENERAL CARE

CAUTION

DO NOT allow the fiber optic light collector tube of the ACOG[®] (Figure 1) to come into contact with harsh organic chemicals such as Acetone, Trichloroethane, or other cleaning solvents. They will affect the appearance of the fiber optic light collector tube though they will not affect its performance.

The ACOG[®] requires very little maintenance. If the lenses become dirty, wash using fresh water and a soft clean cloth. Be sure to wash the lenses fully before wiping them with a soft cloth. The lenses can be scratched if dirt is pulled along the lens by the cloth. The outside lens may fog over in cold weather. Remove fog by using a dry, clean soft cloth.

Anti-fog solutions can be applied to the exterior of the lenses to help prevent fogging during temperature changes.

Using the Lens Pen

To clean the BAC ACOG® utilizing the Lens Pen (Figure 28), first depress and push forward the Lens Brush Slider, exposing the Lens Brush. Use this brush to remove all foreign material from the unit if fresh water is not available. Pay special attention to the lenses.



Figure 28

CAUTION

Remove all foreign material from the lenses before cleaning them with the lens pen. This will prevent damage to the lenses.

Next, remove the cap from the opposite end of the Lens Pen to expose the Felt Lens Cleaner. Ensure there is NO foreign material on the felt surface. Starting in the center

of the lens, press the felt surface of the lens cleaner against the lens and in a spiral motion, work from the center to the outside edge of the lens. Repeat if necessary.

When finished, depress Lens Brush Slider and retract the brush into the Lens Pen. Replace the cap over the Felt Lens Cleaner as seen in **Figure 29**.



Figure 29

TROUBLESHOOTING

This section contains troubleshooting information and tests for locating and correcting most of the troubles which may develop in the operation of the BAC ACOG®. Each trouble symptom for an individual unit is followed by a list of test or inspections for determining probable causes and suggested actions to remedy the problem.

The BAC reticle is blurred or fuzzy:

1. Inspect the eyepiece lens to ensure it is free of any foreign materials and/or smudges. Clean the lenses if needed as per Cleaning and General Care section.
2. Inspect the objective lens to ensure it is free of any foreign materials and/or smudges. Clean the lenses if needed as per Cleaning and General Care section.
3. Contact Trijicon for repair or replacement.

The BAC optic will not adjust:

Contact Trijicon for return information.

THE BAC optic will not zero:

1. Inspect the mounting on the firearm and to the base of the optic.
2. Mount the optic to another firearm to ensure the problem is the optic and not the firearm.
3. Contact Trijicon for return information.

3.5x35 & 4x32 ACOG® MODELS & AVAILABLE ACCESSORIES

Optics

MFG #	Description
TA11	ACOG® 3.5x35 Scope, Dual Illumination Red Donut .223 Ballistic Reticle
TA11B	ACOG® 3.5x35 Scope, Dual Illumination Red Circle/Chevron Reticle
TA11C	ACOG® 3.5x35 Scope, Dual Illumination Red Donut .308 Ballistic Reticle
TA11D	ACOG® 3.5x35 Scope, Dual Illumination Red Triangle .223 Ballistic Reticle
TA11E	ACOG® 3.5x35 Scope, Dual Illumination Red Chevron .308 Ballistic Reticle w/ TA51 Mount
TA11F	ACOG® 3.5x35 Scope, Dual Illumination Red Chevron .223 Ballistic Reticle w/ TA51 Mount
TA11F-A	ACOG® 3.5x35 Scope, Dual Illumination Amber Chevron .223 Ballistic Reticle w/ TA51 Mount
TA11-G	ACOG® 3.5x35 Scope, Dual Illuminated Green Donut .223 Ballistic Reticle
TA11H	ACOG® 3.5x35 Scope with Horseshoe Reticle .223 Ballistic Reticle w/ TA51 Mount

MFG #	Description
TA11H-308	ACOG® 3.5x35 with Horseshoe .308 M240 BDC Reticle w/TA51 Mount
TA31	ACOG® 4x32 Scope, Dual Illumination Red Donut .223 Ballistic Reticle
TA31A	ACOG® 4x32 Scope, Dual Illumination Red Triangle .223 Ballistic Reticle
TA31F	ACOG® 4x32 Scope, Dual Illumination Red Chevron .223 Ballistic Reticle w/ TA51 Mount
TA31F-G	ACOG® 4x32 Scope, Dual Illuminated Green Chevron .223 Ballistic Reticle w/ TA51 Mount
TA31H	4x32 ACOG® with Horseshoe/Dot Reticle and M4 BDC w/TA51 Mount
TA31H-6.8	ACOG® 4x32 Scope, Dual Illuminated Red Horseshoe/Dot 6.8 Ballistic Reticle w/ TA51 Mount
TA31RMR	ACOG® 4x32 w/Dual Illuminated Crosshair Reticle w/4.0 MOA Trijicon RMR and TA51 Flattop Mount
TA31F	ACOG® 4x32 Scope, Dual Illuminated Red Chevron .223 Ballistic Reticle, 4.0 MOA RMR™ Sight, TA51 Mount and Dust Cover

ACOG® Mounts

MFG #	Description
TA03	ACOG® Adapter for H&K Rifles
TA12	A.R.M.S.® Throw Lever Adapter for Picattiny Rails
TA12W	A.R.M.S.® Throw Lever Adapter for Weaver Rails
TA18	A.R.M.S.® #10 ACOG® Multi-Position Channel Mount
TA51	ACOG® Picattiny Rail Adapter with Colt style thumbscrews
TA51W	ACOG® Weaver Adapter with Colt style thumbscrews
TA70	M14/M1A Low Profile Picattiny Rail Mount
TA77	ACOG® Extended Eye Relief Picattiny Rail Adapter with Colt style thumbscrews

ACOG® Accessories

MFG #	Description
TA30	ACOG® Extra Screw & Washer Set
TA35	Rubber Eyepiece for 4x32 and 3.5x35 ACOG® Scope Models
TA52	Rubber Caps for 4x32 ACOG® Scope Models
TA53	ACOG® Thumb Screw
TA53A	ACOG® Thumb Screw (RCO)
TA57	Tenebraex killFLASH® Anti-Reflection Device for 4x32 ACOG® Scope Models

TA63	Scopecoat fitted for 3.5x35 ACOG® Scope Models
TA64	Scopecoat fitted for 4x32 ACOG® Scope Models (not for NSN models)
TA66	Tenebraex killFLASH® Anti-Reflection Device for 3.5x35 ACOG® scope
TA69	Scopecoat for 4x32 ACOG® with DOC/TRD
TA71	ACOG® Adjuster Caps & Lanyard
TA86	RCO ACOG® Pouch
TA88	Medium Sized Pelican Case for TriPower, 1.5x, 2x, 3x and 4x Model ACOG's®
TA89	Large Sized Pelican Case for 3.5x and 6x Model ACOG's®
TA90	4x32 Flip Cap Set (requires TA91 killFLASH®)
TA91	Tennebrex killFLASH® Anti-Reflection Device for 4x32 RCO ACOG® Scope
TA94	4x32 Flip Cap for Objective (requires TA91 killFLASH®)
TA95	4x32 Flip Cap for Eye Piece
TA96	4x32 ACOG® Heavy Duty Scopecoat
LENSPEN	Trijicon LENS PEN® for all optics

** Denotes a special order item*

LENSPEN® is a registered trademark of International Parkside Products Inc.
A.R.M.S.® is a registered trademark of Atlantic Research Marketing Systems, Inc.
killFLASH® is a registered trademark of Tenebraex Corporation.
Scopecoat™ is a registered trademark of Devtron Diversified (Devtron Scopecoat)

PATENTS AND TRADEMARKS

The ACOG® is covered by the following patents:

- ▼ U.S. 4,806,007
- ▼ Germany D.B.P. No. P3853127.5
- ▼ Great Britain EP 0315379
- ▼ Canada 1,305,341
- ▼ Austria EP 0315379
- ▼ Australia 605076
- ▼ South Africa 88/8185
- ▼ Switzerland EP 0315379+NO
- ▼ France EP 0311579
- ▼ Japan 2632976

Other U.S. and foreign patents are Pending.

The ACOG® is covered by the following design trademarks:

- ▼ U.S. 3,190,442
- ▼ U.S. 3,047,581
- ▼ U.S. 3,047,582

Other U.S. and foreign trademarks are pending.

LIMITED LIFETIME WARRANTY

The original owner of the Trijicon® product registered with this card is entitled to repair or replacement (at our option) of the registered item if it should fail due to defects in material or workmanship during normal use. This warranty specifically applies to the optical systems and metal structure of the product and does not apply to the illumination system. The tritium lamp is warranted to glow for five years for orange night sights, ten years in non-fiber optic scopes, twelve years in green and yellow night sights or fifteen years in fiber optic scopes from date of original manufacture. If repair is necessary, please contact our Customer Service Department for return instructions. This warranty does not apply to defects caused by anything which is deemed abnormal, abusive, or improper including any fault resulting from an accident or improper service. Special Note: Trijicon® PRODUCTS CONTAIN TRITIUM AND ARE REGULATED BY THE NUCLEAR REGULATORY COMMISSION. THEY MAY NOT BE DISASSEMBLED BY ANYONE OTHER THAN TRIJICON, INC WHICH HOLDS THE NECESSARY LICENSES. Any attempt at disassembly or repair will annul this warranty. This warranty gives you specific legal rights, and you may also have other rights which vary from state to state.

Trijicon, Inc.
49385 Shafer Avenue
P.O. Box 930059
Wixom, MI 48393-0059
1-800-338-0563
248-960-7700
www.trijicon.com