



LASER AMMO
TRAINING TECHNOLOGIES

LaserPET II

PERSONAL ELECTRONIC TARGET

IMPROVE YOUR SHOOTING
SKILLS ANYTIME, ANYWHERE

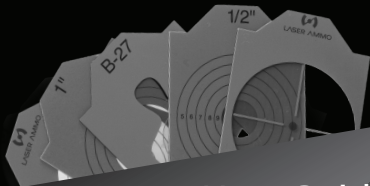

User Guide

*Before using Laser Ammo products,
please read the user guide in full*

Introduction

Laser Ammo's electronic target systems are designed to improve shooting skills such as drawing, target acquisition, trigger squeeze, pistol control and much more, while building a solid foundation for accuracy. All targets can be combined with any of our SureStrike™ laser training cartridges for immediate audio, visual and numeric feedback with multiple training options.

The LaserPET II™ is built for any level of shooter, to train on their speed, accuracy, holstering and reload time. With 6 different training programs and new features that include: Bright 4-digit Numeric Screen, Flash and Sound Activation and Response, Shot Timer, Split and Elapsed Time Scores.

This electronic target system is equipped with user defined drill parameters, five (5) different target cards that changes the hit zone from 0.5" up to 1.8", external power mini USB connector (not included), and is useable in both indoor and shaded outdoor environments. Combined with either our Red or IR SureStrike™ laser training cartridges, the LaserPET II™ is the best and most advanced personal training tool on the market today.

Diagram

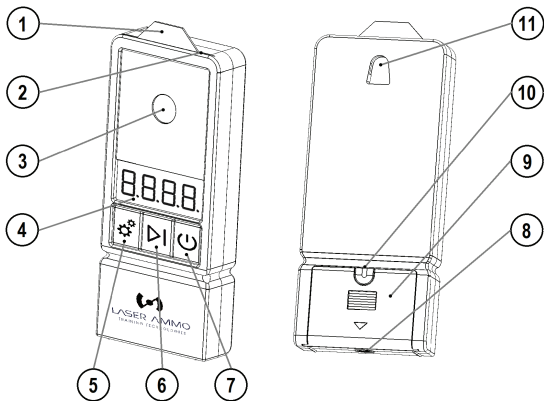

1. Target Card
2. Target Insert Slot
3. Sensor Screen
4. Numerator Display



5. Setting
6. Program Run
7. On/off

8. Tripod Mount
9. Battery Cover
10. Micro USB Connector
11. Wall Mount

Safety Information

- ⚠ Unload your firearm.
- ⚠ Physically and visually inspect the chamber, bore and magazine well to ensure all ammunition has been removed.
- ⚠ Store ammunition in an area that is separate from your training area.
- ⚠ **WARNING:** Failure to follow safety instruction may result in injuries or death.
- ⚠ Always personally verify that all ammunition has been removed before training.
- ⚠ Do not allow any live ammunition in the training area.

Getting Started

- Install two (2) AAA batteries in the battery compartment ⑨
Or connect a micro USB cable and charger (not included) to the USB port through the battery compartment.
- Choose preferred Target card ①, remove protective film and insert into Target Insert Slot ②
- Place the target in preferred position using the provided tripod ⑧ or wall mount ⑩
- Press  to turn target ON or OFF ⑦
 - Battery power level bars will show momentarily
 - o (low) to oooo (full) ④
- Press  'Settings' ⑤ to set target / training parameters.
 - Settings options are detailed in "Setting Target Parameters."
- Press  'Program Run' ⑥ to change between the six training programs.
 - The different Program drills are detailed below in "Programs-Training Drills" on pages 5 - 7.
- You are ready to Go! Aim your Red or IR SureStrike™ prepared firearm at the opening on the Training Card ③ and fire.

Programs - Training Drills

P1 – Hit Counter

Basic target program to count hits.

- Start shooting the target. Target will flash and beep and displays the number of hits.
- To reset, press **▶I** until you return to P1.

P2 – Shot Timer: Measures reaction time to 1st hit.

- Target will delay for a random time followed by a FLASH and BEEP to indicate "GO" and start an elapsed timer.
- Stop the timer by shooting the target.
 - ⊙ Try clearing failure drills like a stovepipe, double feed or fail to seat.
- Your hit time score will be displayed for a few seconds before the drill will automatically re-start.

P3 – Trigger Control / Pressured Shooting

Counts the number of hits within a pre-set run-time*

- Target will count down the pre-set Ready Time* followed by a FLASH and BEEP to indicate "GO" and start the run-time countdown.
 - ⊙ Practice quick, controlled, repeated shots under the time pressure or shooting and reloads.
- Your total hits score will be displayed for a few seconds before the drill automatically re-starts.

Programs - Training Drills

P4 – Double-Tap/Reload Timer

Measures time from 1st to 2nd hits.

- Target will count down the pre-set ready-time* followed by a BEEP and the Numerator Display will continue to FLASH to indicate it's ready for 1st hit.
- Once you hit the target, a timer will start until your 2nd hit stops it.
- Try controlled double-tap or reload drills by shooting the target, reload/magazine change and shooting the target again.
- Your time score between 1st and 2nd hits will be displayed for a few seconds before the drill automatically re-starts.

P5 – Multiple Shot Timer, Elapse Time

Measures elapse time between start and each hit.

- The required number of shots to complete the drill will momentarily display*
- Target will delay for a random time followed by a FLASH and BEEP to indicate a start and an elapsed timer will begin.
- Stop the timer by hitting the target the required number of shots to complete the drill.
- Your time scores will be displayed consecutively by indicating "0-#" followed by the corresponding time score.
- Once all scores are displayed, the drill will automatically re-start.

Programs - Training Drills



PS – Multiple Shot Timer, Split Time

Measures split time between hits.

- The required number of shots to complete the drill will momentarily display*
- Target will delay for a random time followed by a FLASH and BEEP to indicate a start and an elapsed timer will begin.
- Stop the timer by hitting the target the required number of shots to complete the drill.
- Your time scores will be displayed consecutively by indicating "#Hit" followed by the corresponding time score.
- Once all scores are displayed, the drill will automatically re-start.

* See "Setting Target Parameters" on page 8.

Setting Target Parameters

Press  to enter the “settings” mode, move between settings, and exit “settings”. Press  to change settings value.

SO – Sound: Buzzer sound on/off.

- “SO 1” - Sound ON
- “SO 0” - Sound OFF
 - Use  to switch between the two sound settings

PA – Pre-Drill Ready Time: Number of seconds before drill starts

- “PA 2” to “PA 6” - selectable countdown between 2 and 6 sec.
 - Use  to change the countdown seconds
 - Applicable for programs P3 and P4

RU - Run Time: The total number of seconds the program will last

- “RU 2” to “RU 6” - selectable between 2 and 6 seconds.
 - Use  to change the run time seconds
 - Applicable for program P3 only

HI - Hits to complete the drill: Needed hits to complete drill

- “HI 2” to “HI 6” - selectable between 2 and 6 hits.
 - Use  to change the number of hits
 - Applicable for programs P5 and P6 only

Note: The settings are shared by each program. Changing a setting will affect all programs.

It is always recommended to remove the batteries before storage.

Warranty

Laser Ammo warrants that this product shall be free from material defects and defects in workmanship for the earlier occurrence of:

A period of one (1) year from the date of the purchaser's receipt of the product.

Notice of any warranty claim must be received by Laser Ammo, in writing, prior to the expiration of the warranty period. Laser Ammo reserves the right to inspect the product before honoring the warranty.

Laser Ammo's warranty is limited solely to the above and applies only for the period set forth.

Laser Ammo will not be liable for any loss, damage, direct, incidental or consequential damages of any kind, whether based upon warranty, contract, negligence, or strict liability, or arising in connection with the sale or use of the product by the user or any third party. Laser Ammo's warranty does not cover any damage to the product that results from improper installation, accident, abuse, misuse, natural disaster, insufficient or excessive electrical supply, abnormal mechanical or environmental conditions, or any unauthorized disassembly, repair, or modification.

Warranty

This limited warranty does not apply to any product on which the original identification information has been altered, obliterated or removed.

Laser Ammo will, at its sole option, either repair or replace any part of the product that proves defective by reason of improper workmanship or materials.

In all events, Laser Ammo's maximum liability to the purchaser related to any warranty claim or defect with respect to the product shall not exceed the contract price for the specific product claimed to be defective or unsuitable, or alleged to have been the cause of any damage to the purchaser or any third party.

The foregoing is in lieu of all other warranties, oral, expressed or implied, including, but not limited to, any implied warranties of fitness for a particular purpose.

The provisions of this section shall be applicable to both implied warranties (if any) and expressed warranties.

The provisions of this section shall be applicable to both implied warranties (if any) and expressed warranties.



LASER AMMO
TRAINING TECHNOLOGIES

Product of Laser Ammo USA, Inc.
Phone: (516) 858-1262 (U.S.)

Laser-Ammo.com