

Papercraft

## **SUNWING**

Size - D350 x W800 x H450mm

Material : 19 sheets of A4 paper



This product is designed by Trunk Cultural & Creative Co., LTD.

---

©2022 Sony Interactive Entertainment Europe. Developed by Guerrilla.

Horizon Forbidden West is a trademark of Sony Interactive Entertainment LLC.



## Recommended printing paper

The official finished product is printed on approx. 235 gsm paper.

Please print on 160 gsm to 180 gsm or above A4 paper.

When printing, please choose double-sided printing, long edge flip, and color printing.

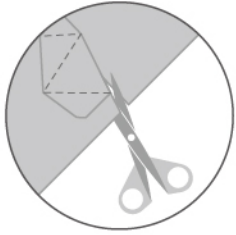

1. Cut the shapes along the solid lines.

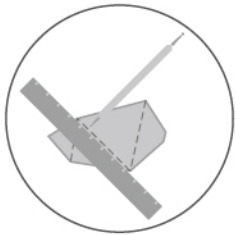

2. Use a creasing pen (or the back of a cutter knife) to score along the dotted lines.

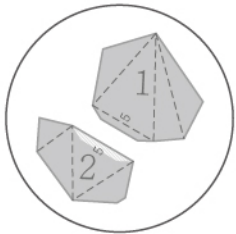

3. Paste or insert the pieces in numerical order (big numbers), then match the small numbers and glue the flaps. (no need to follow numerical order)

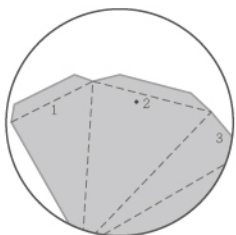

4. Start gluing from the flaps marked with "." to facilitate subsequent steps.

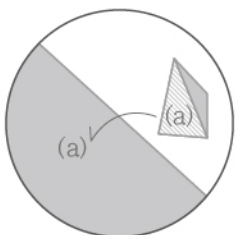

5. After the extra parts are assembled, match the number of parts with the same number on the main body, then paste them to the glue area or insert them.

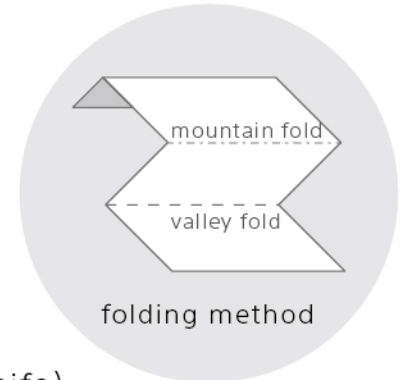



'R = right side  
'L = left side

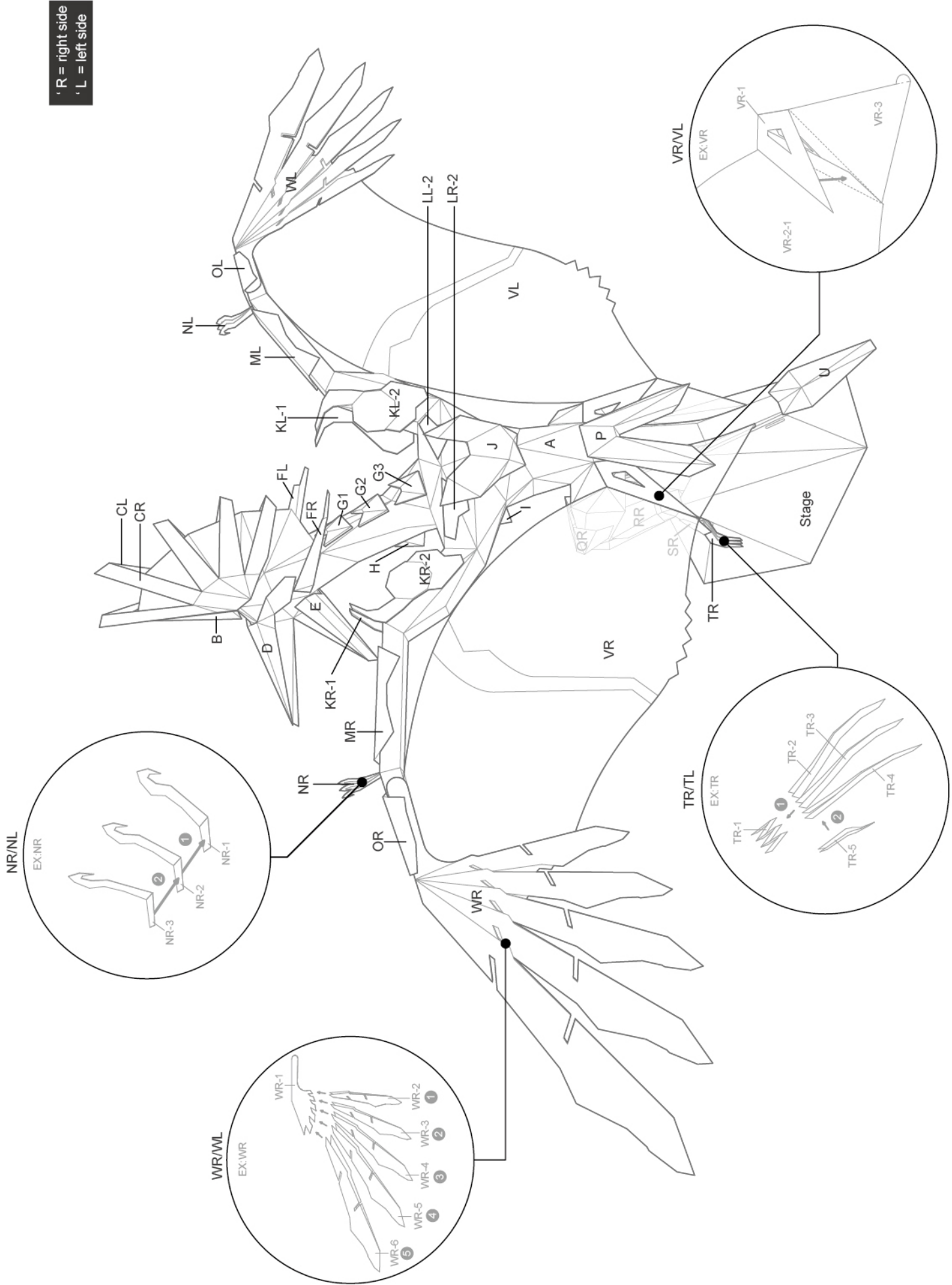



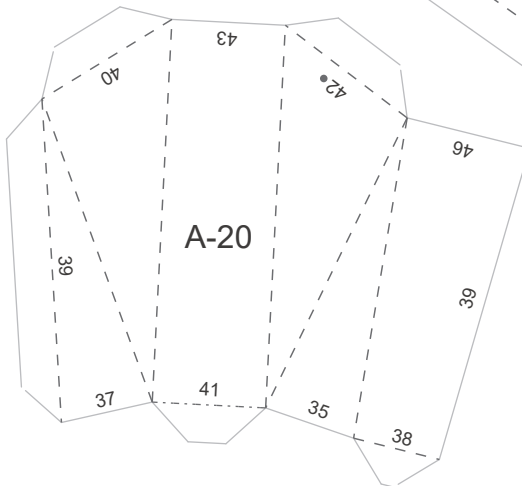
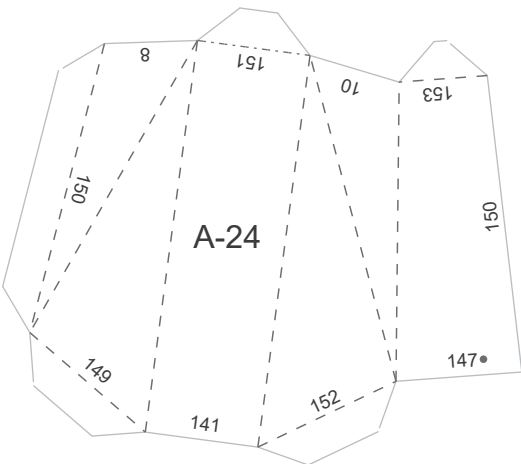
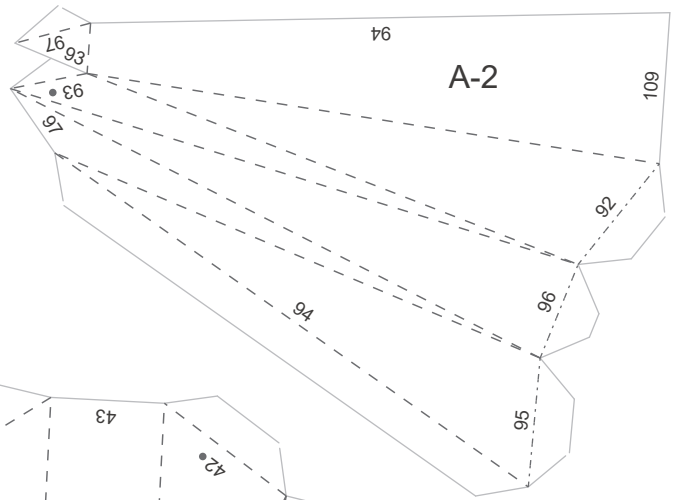
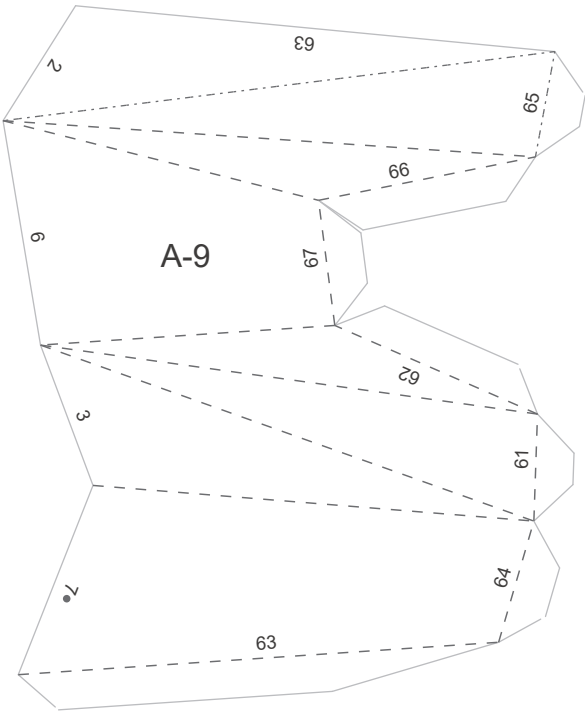
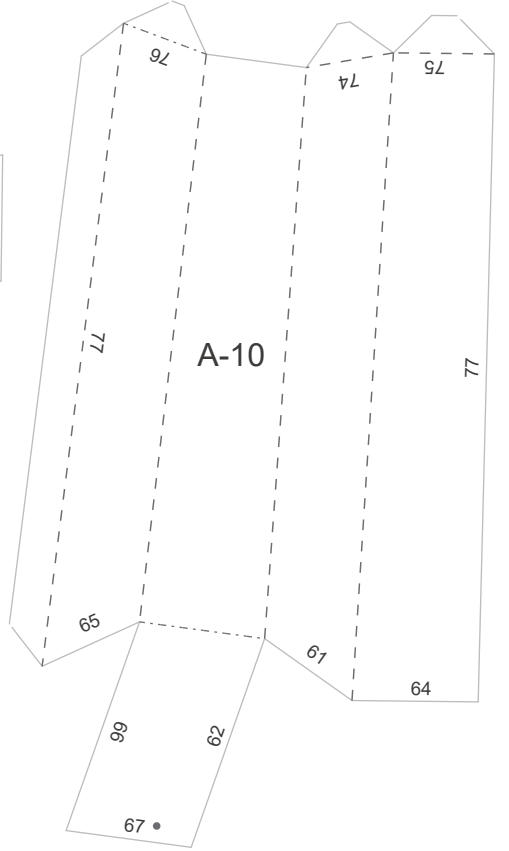
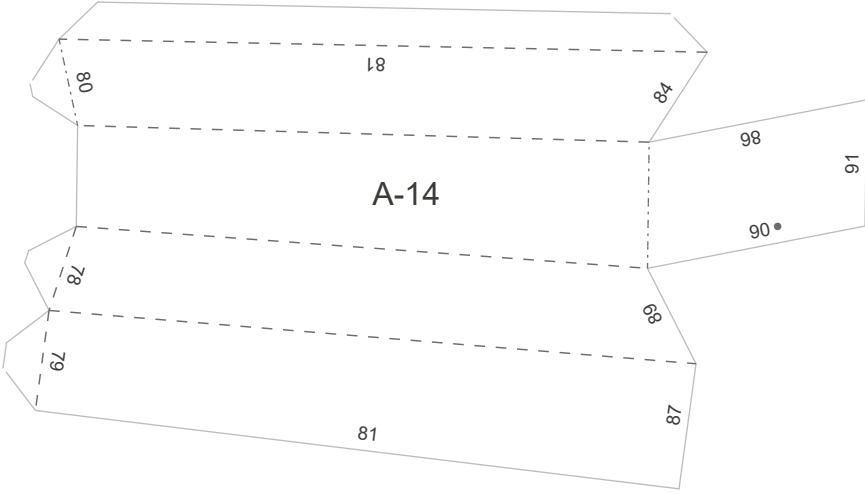
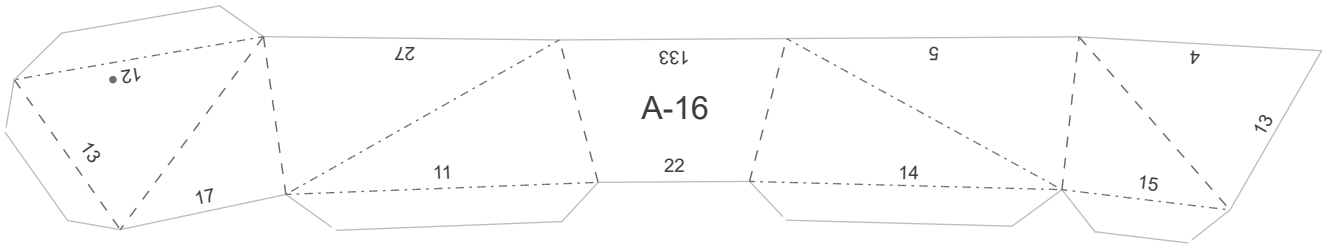

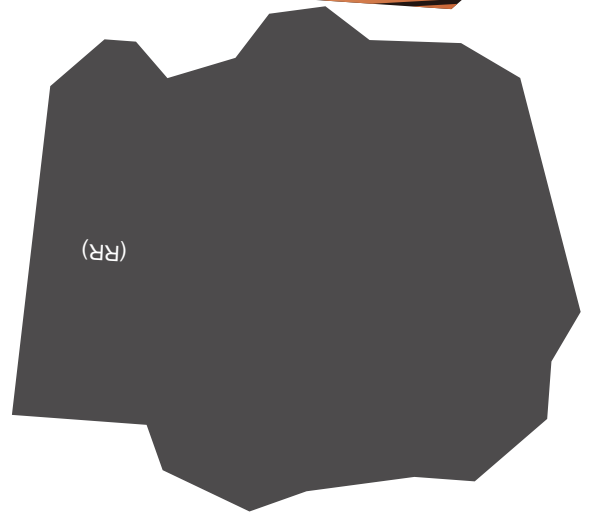
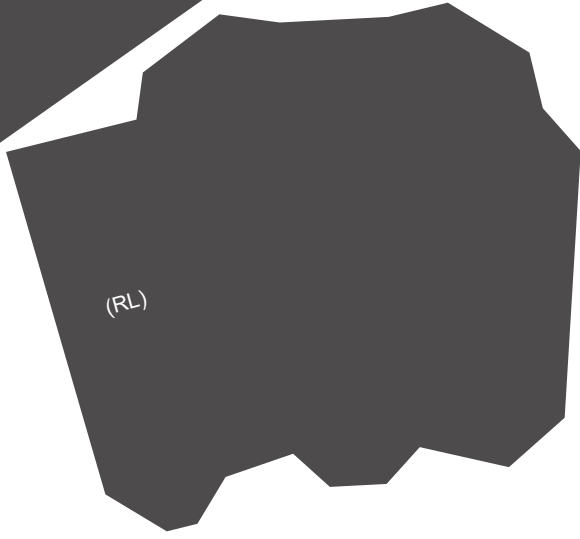
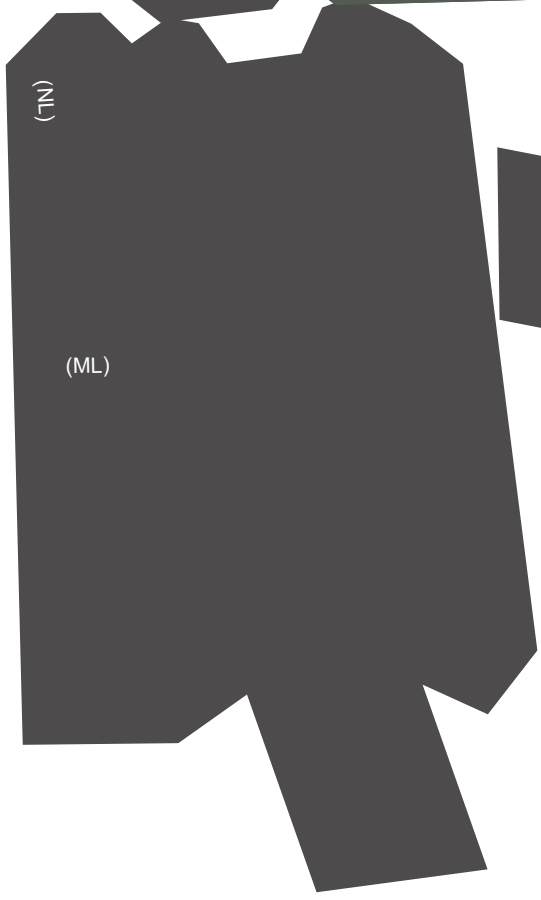
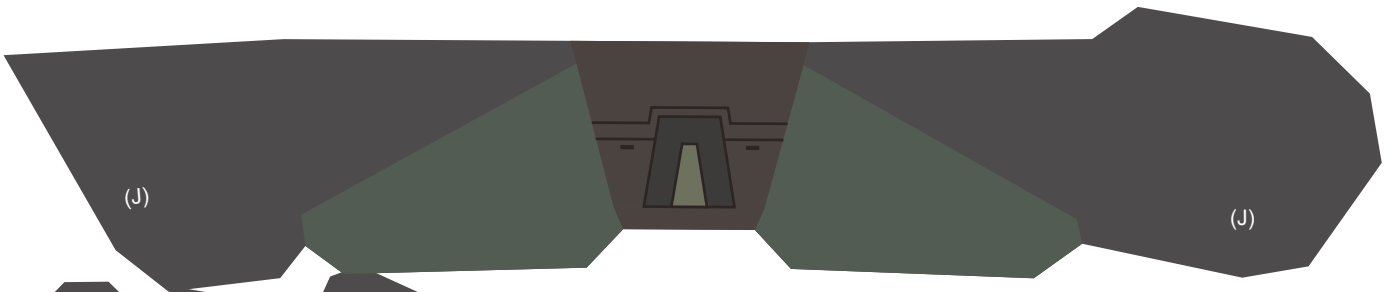







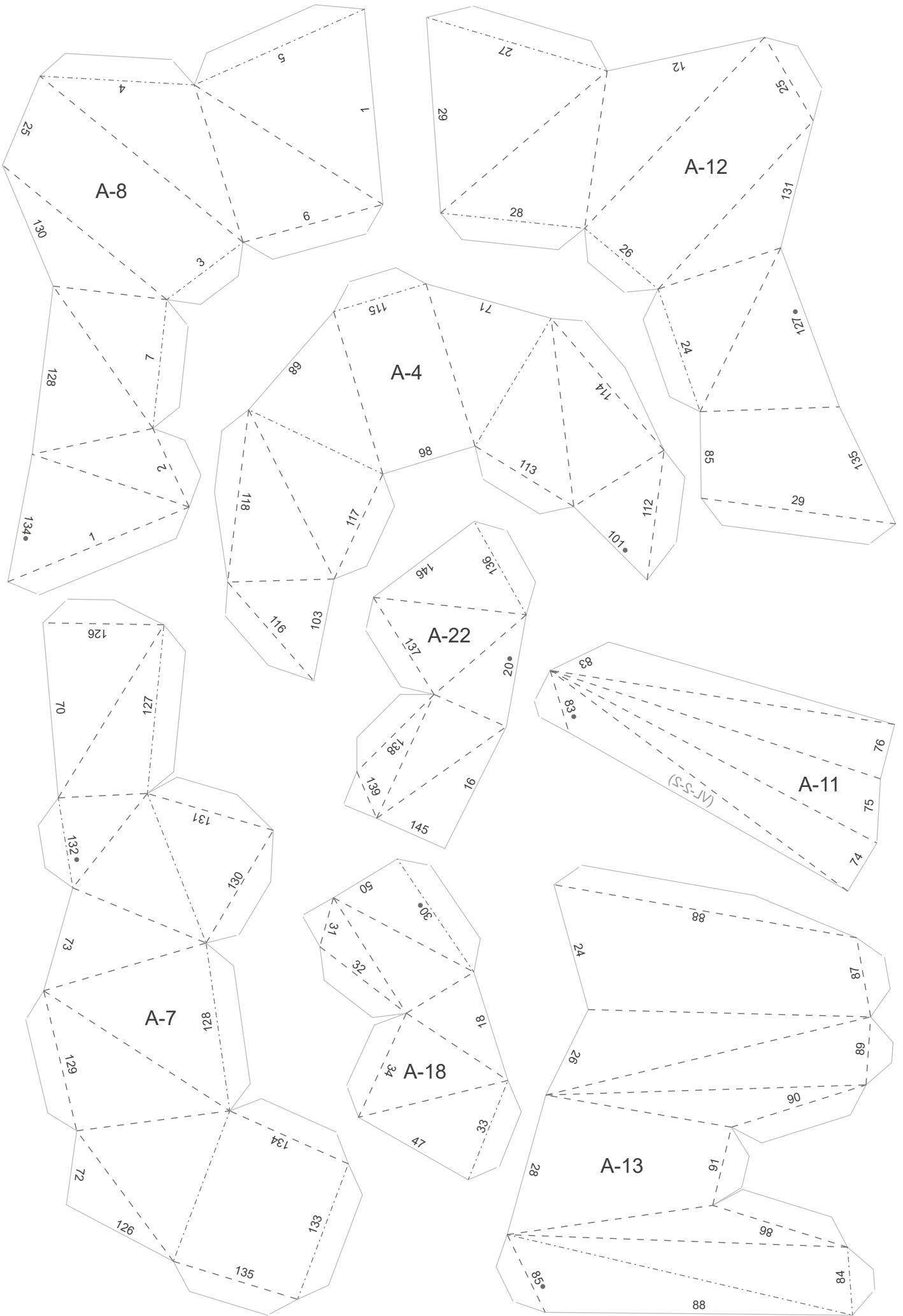

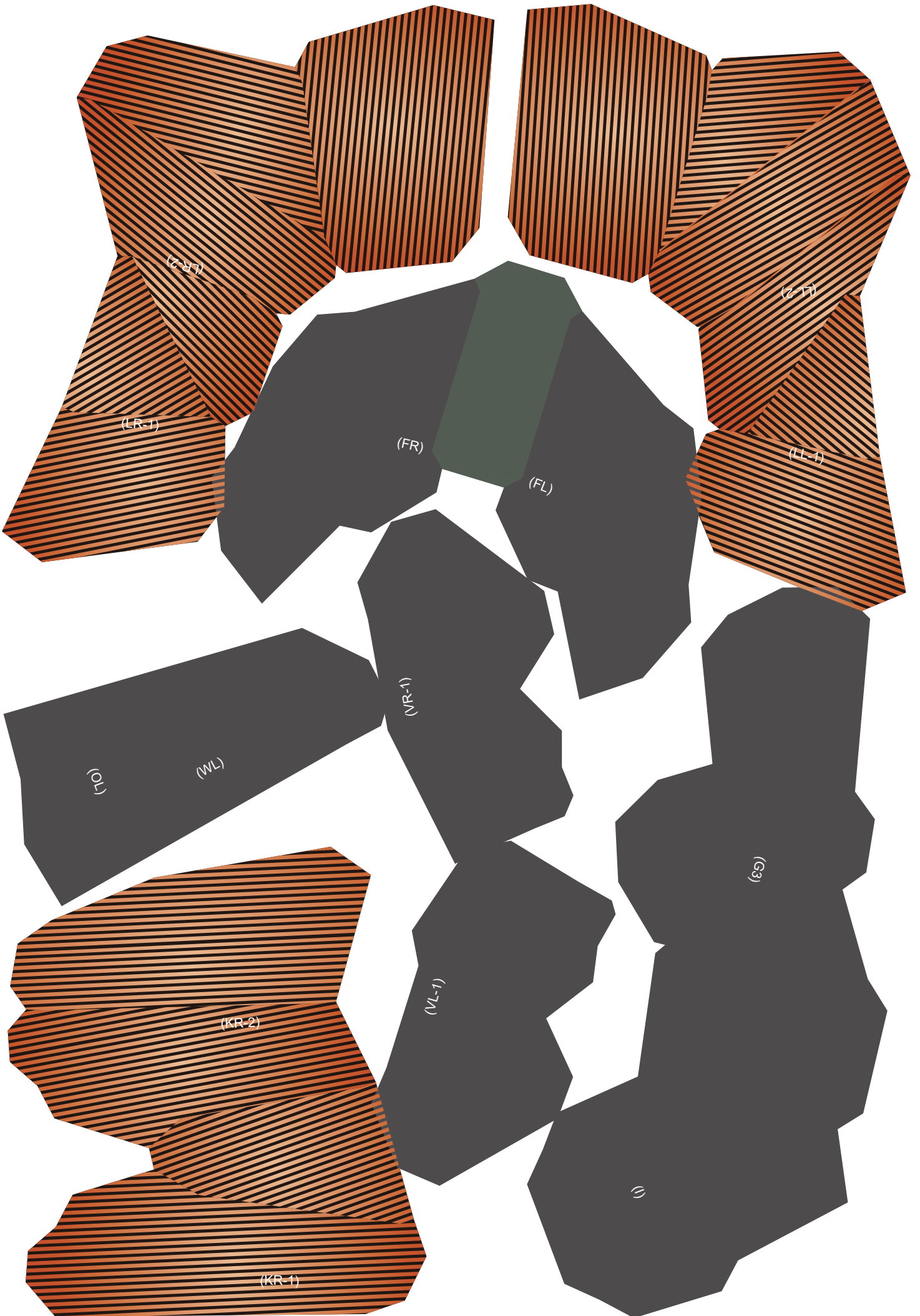

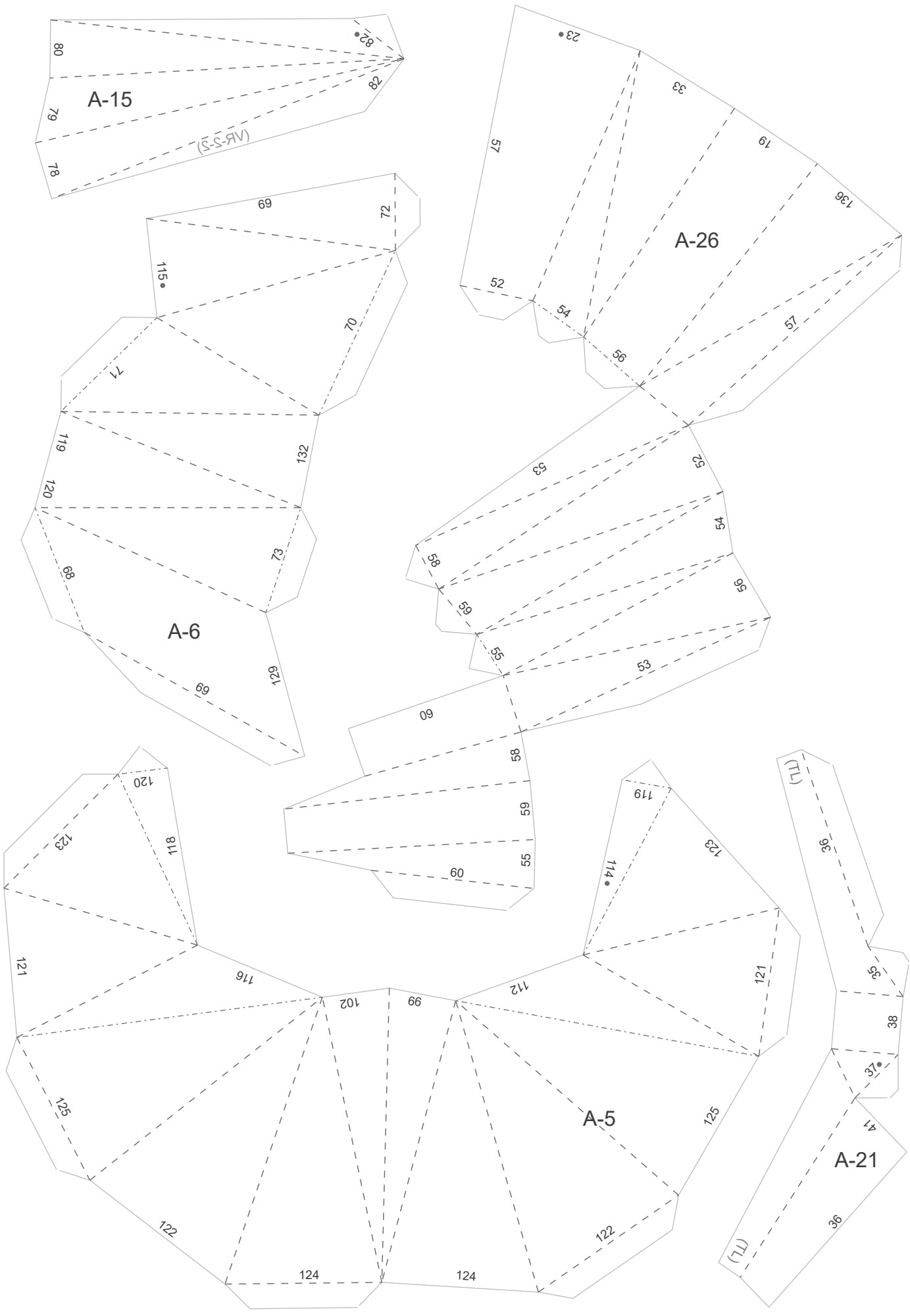

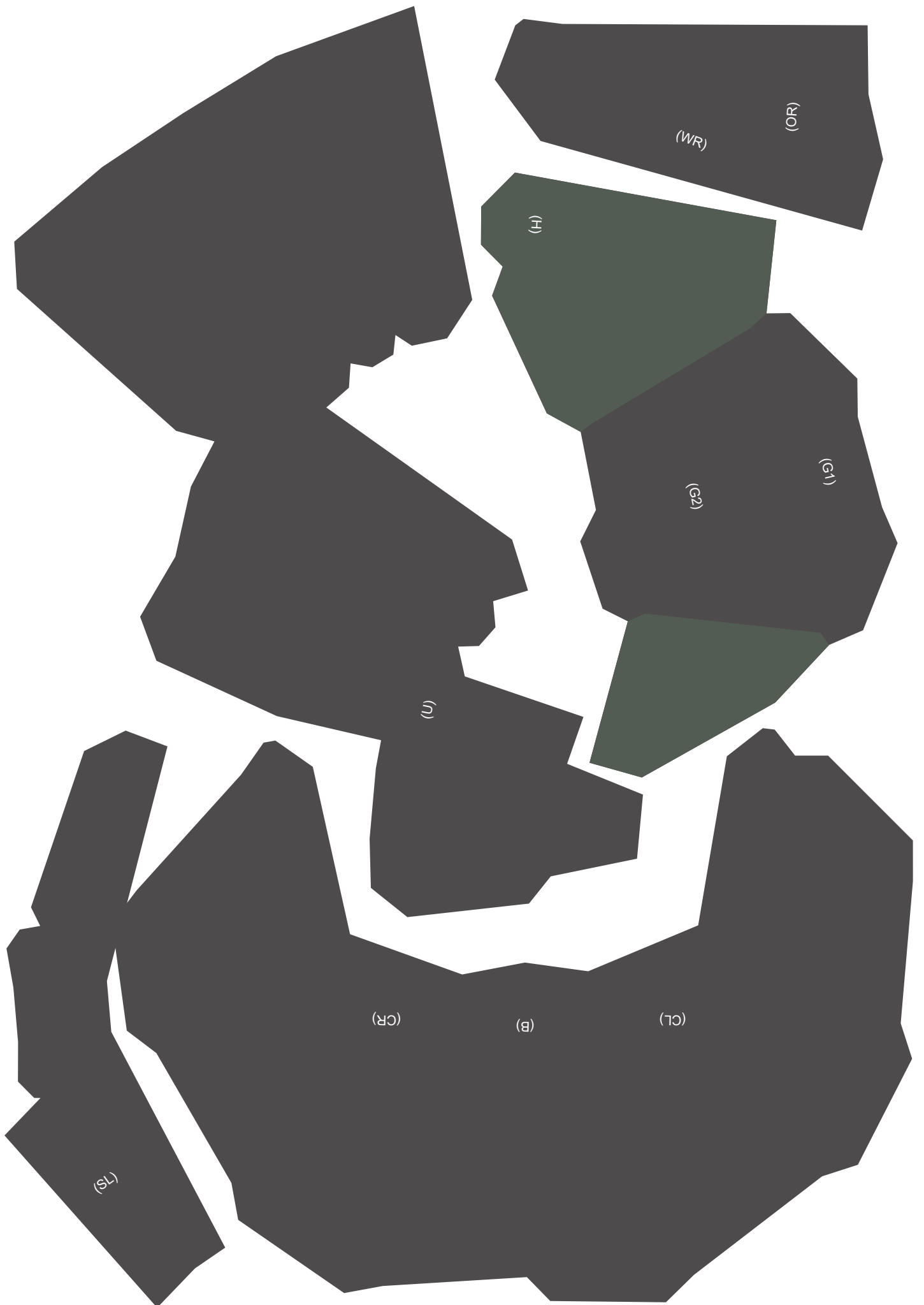

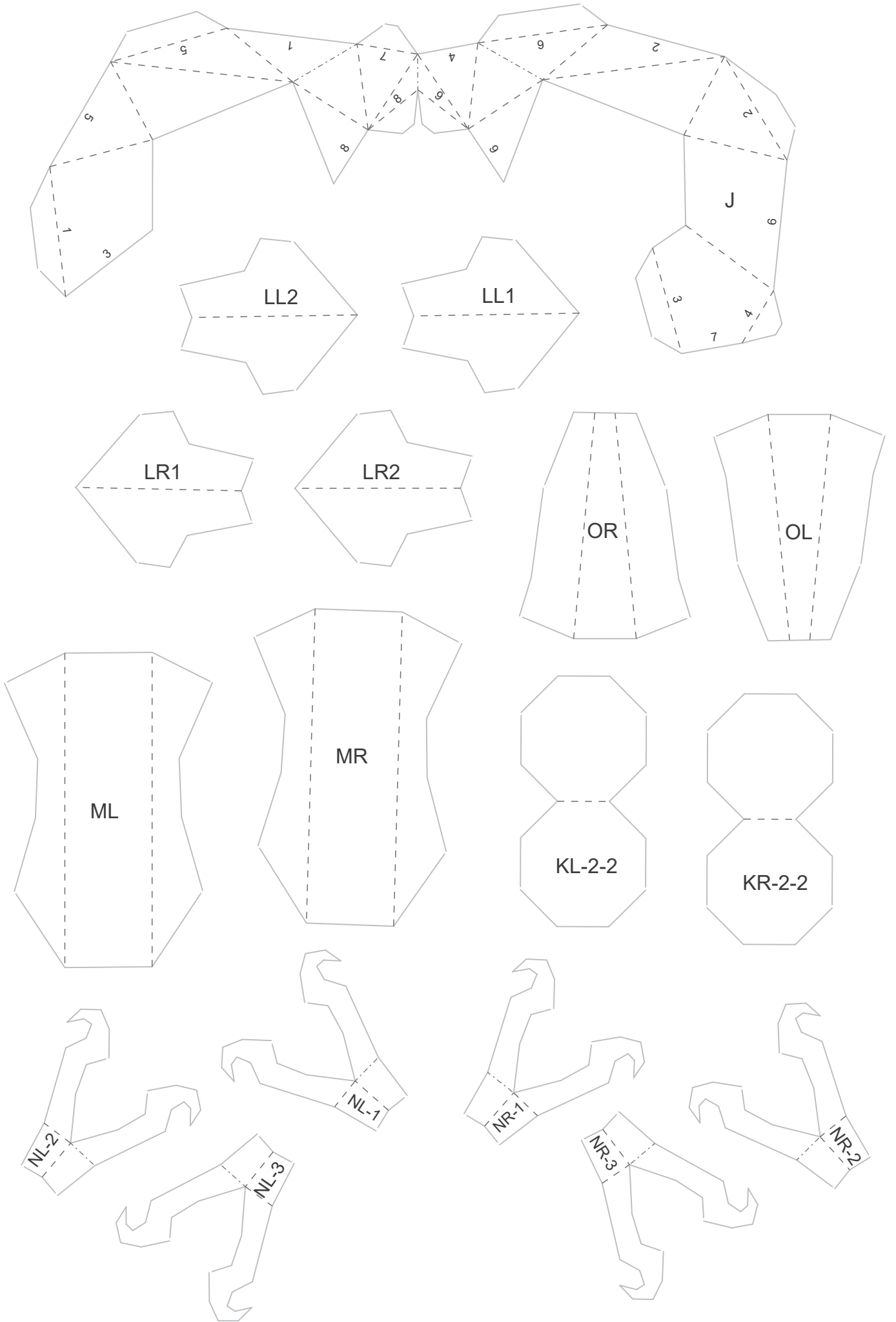

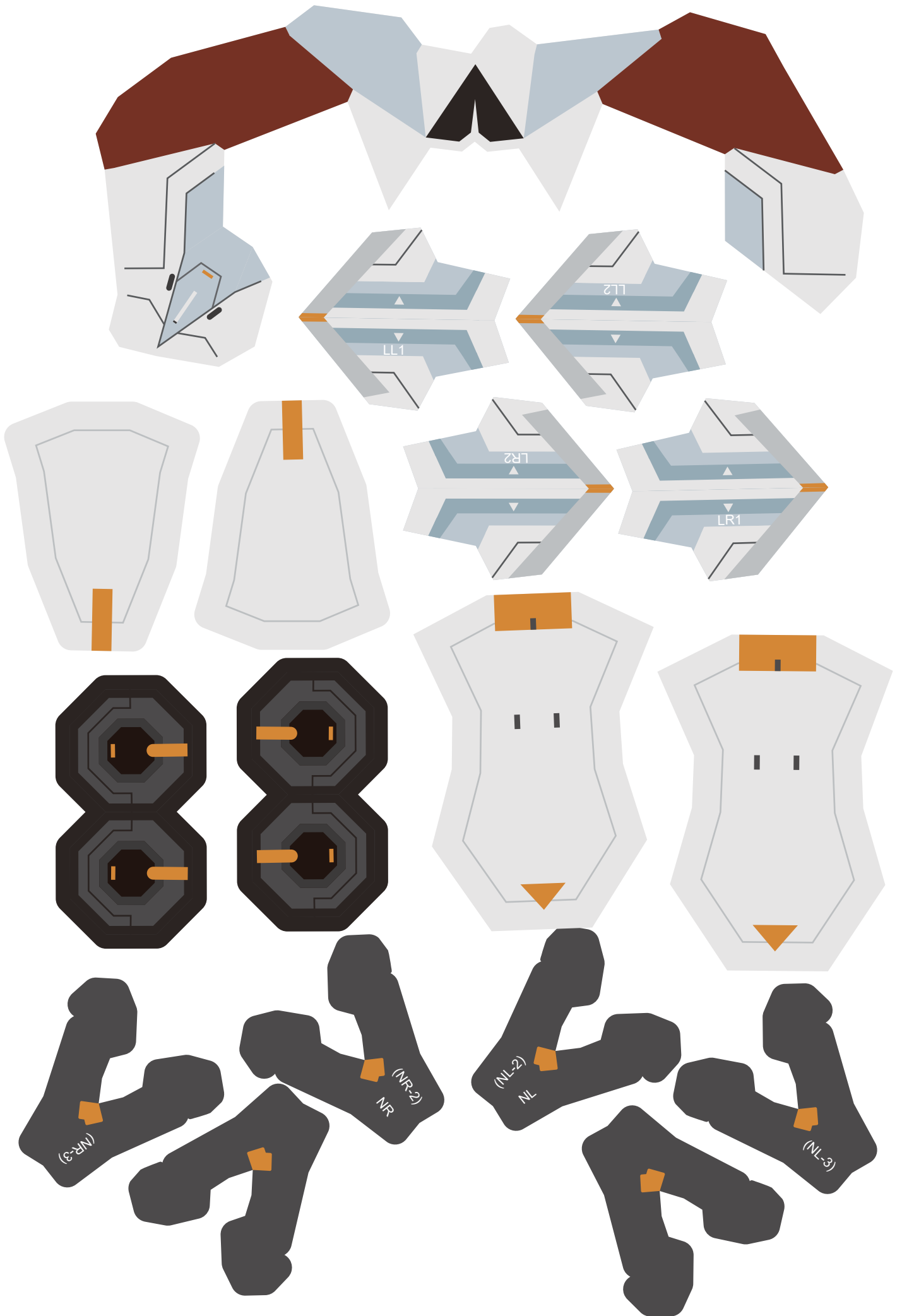



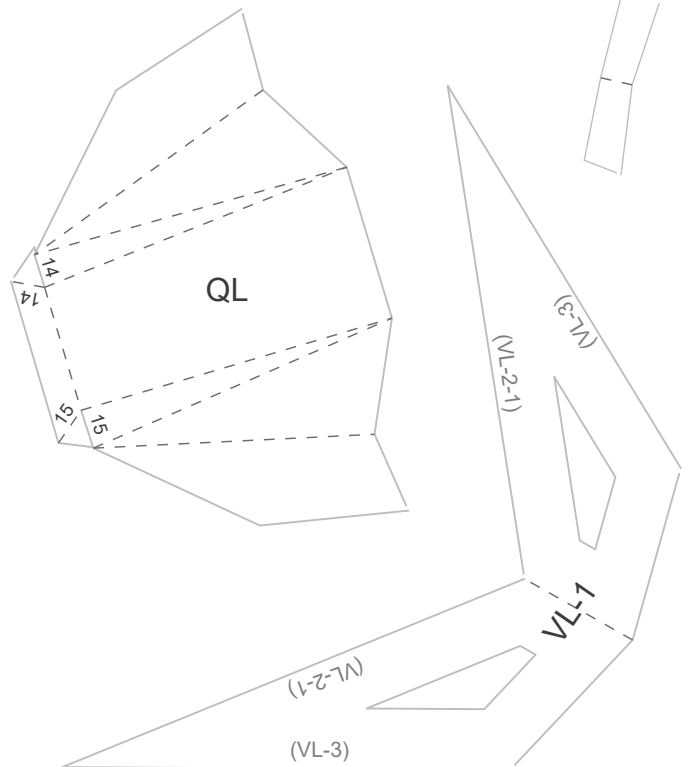
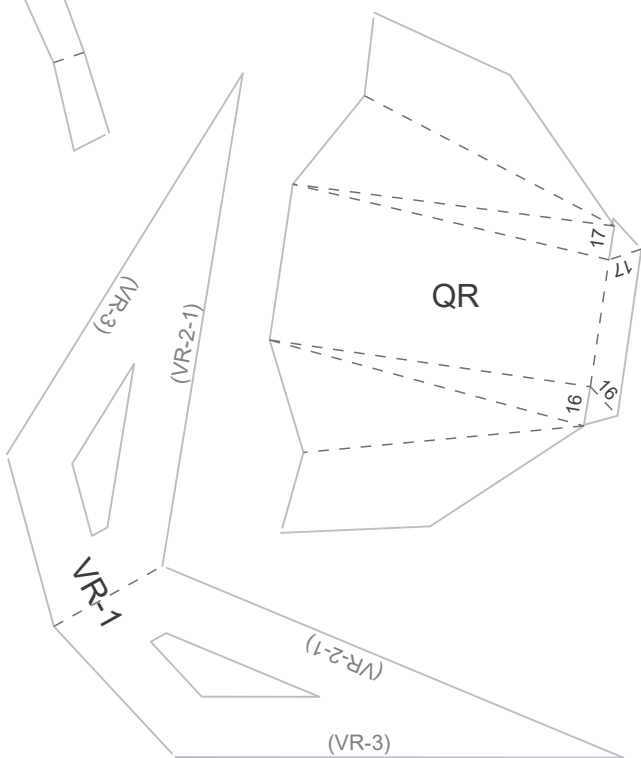
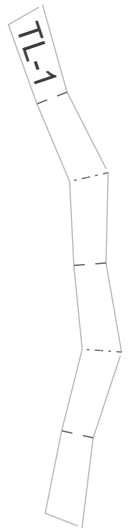
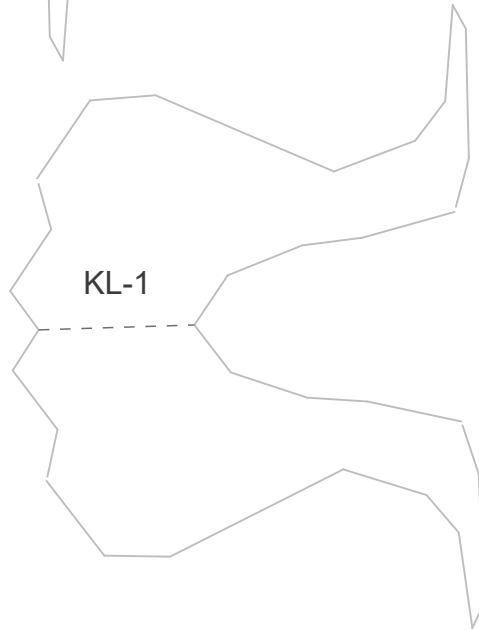
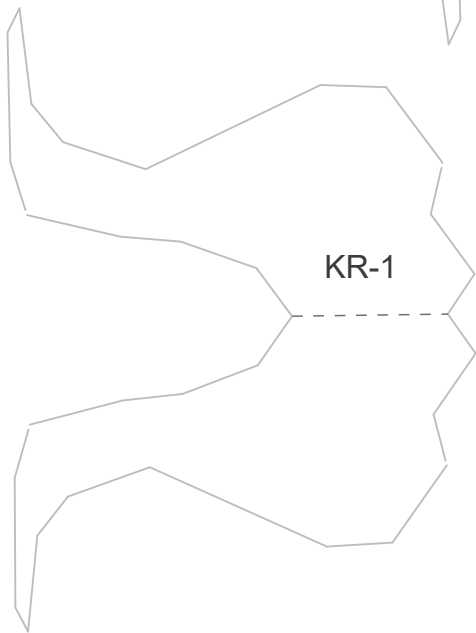
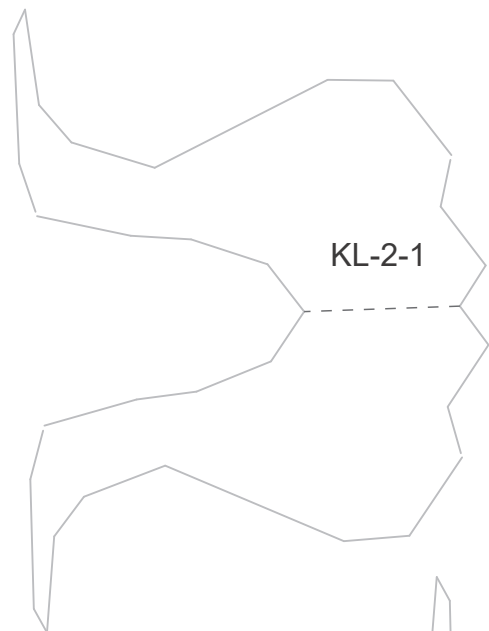
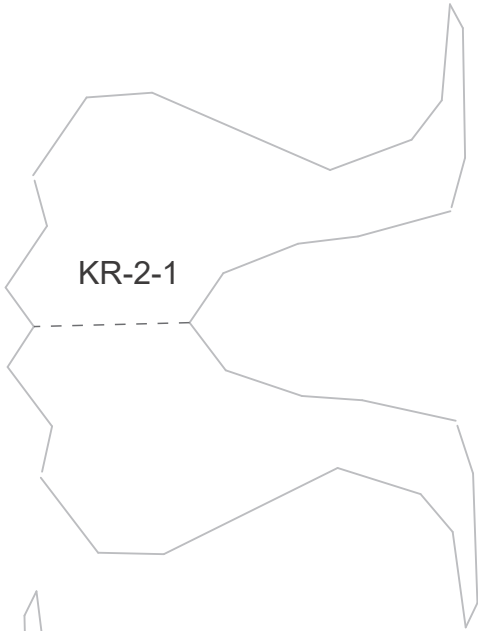



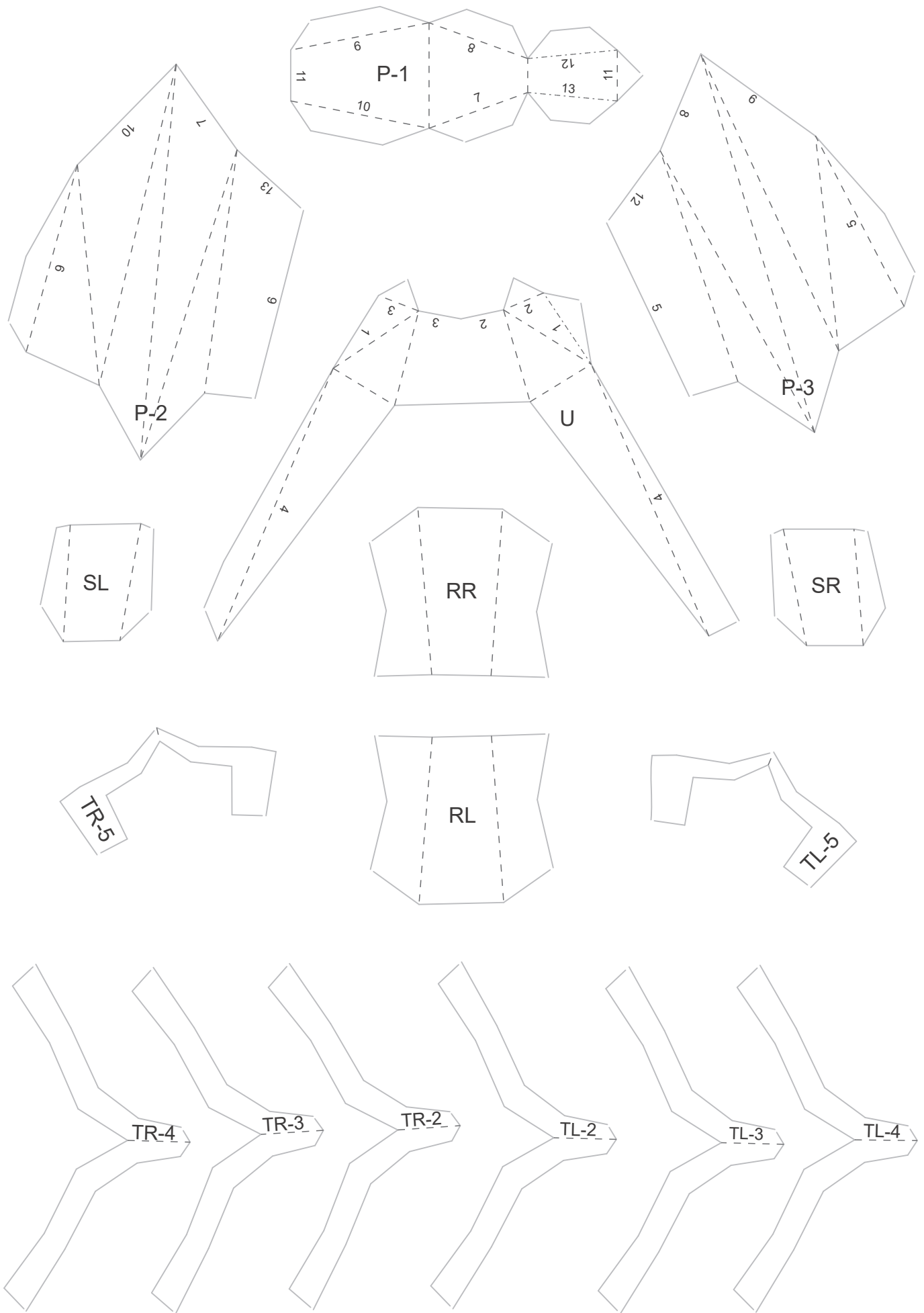



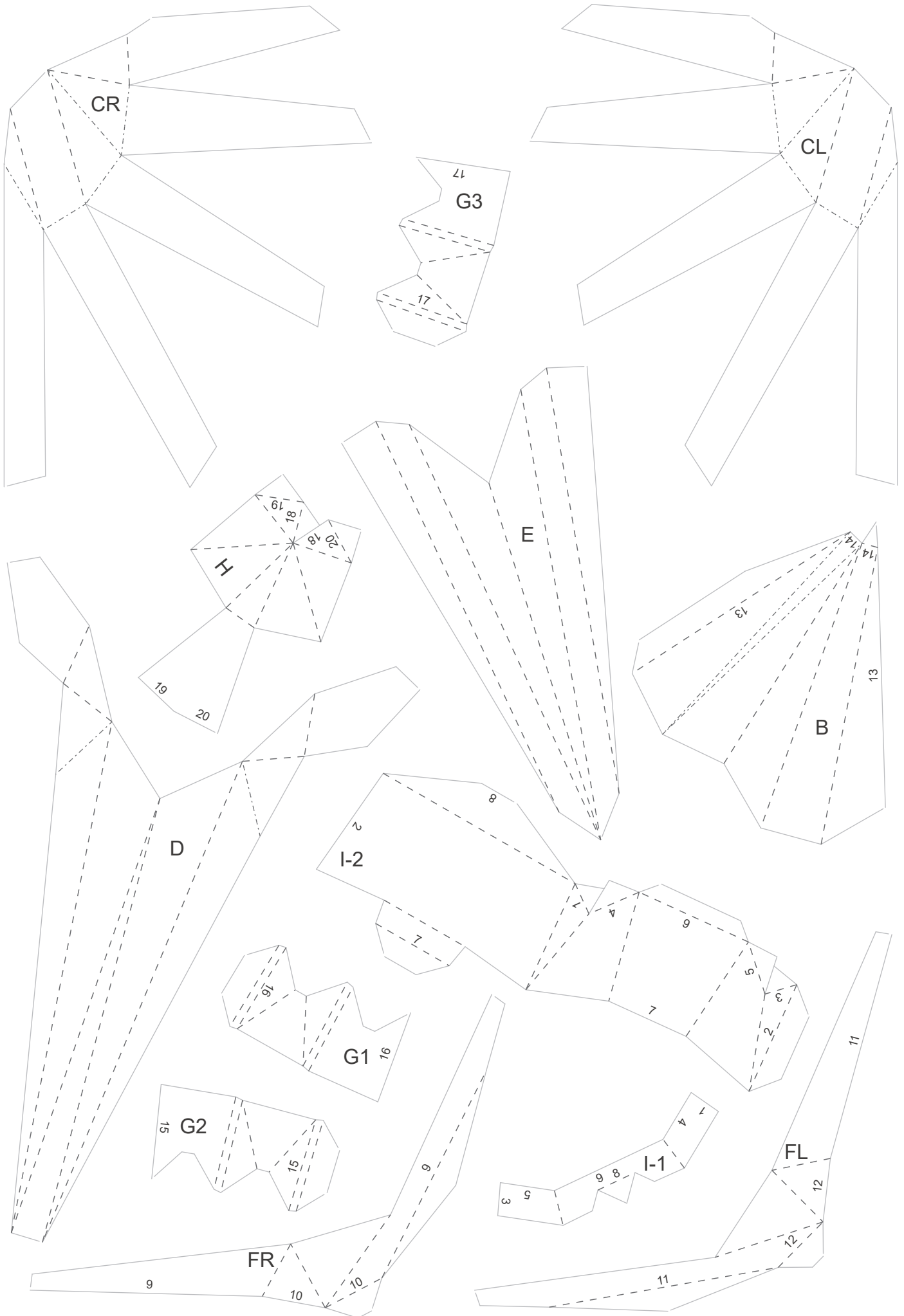



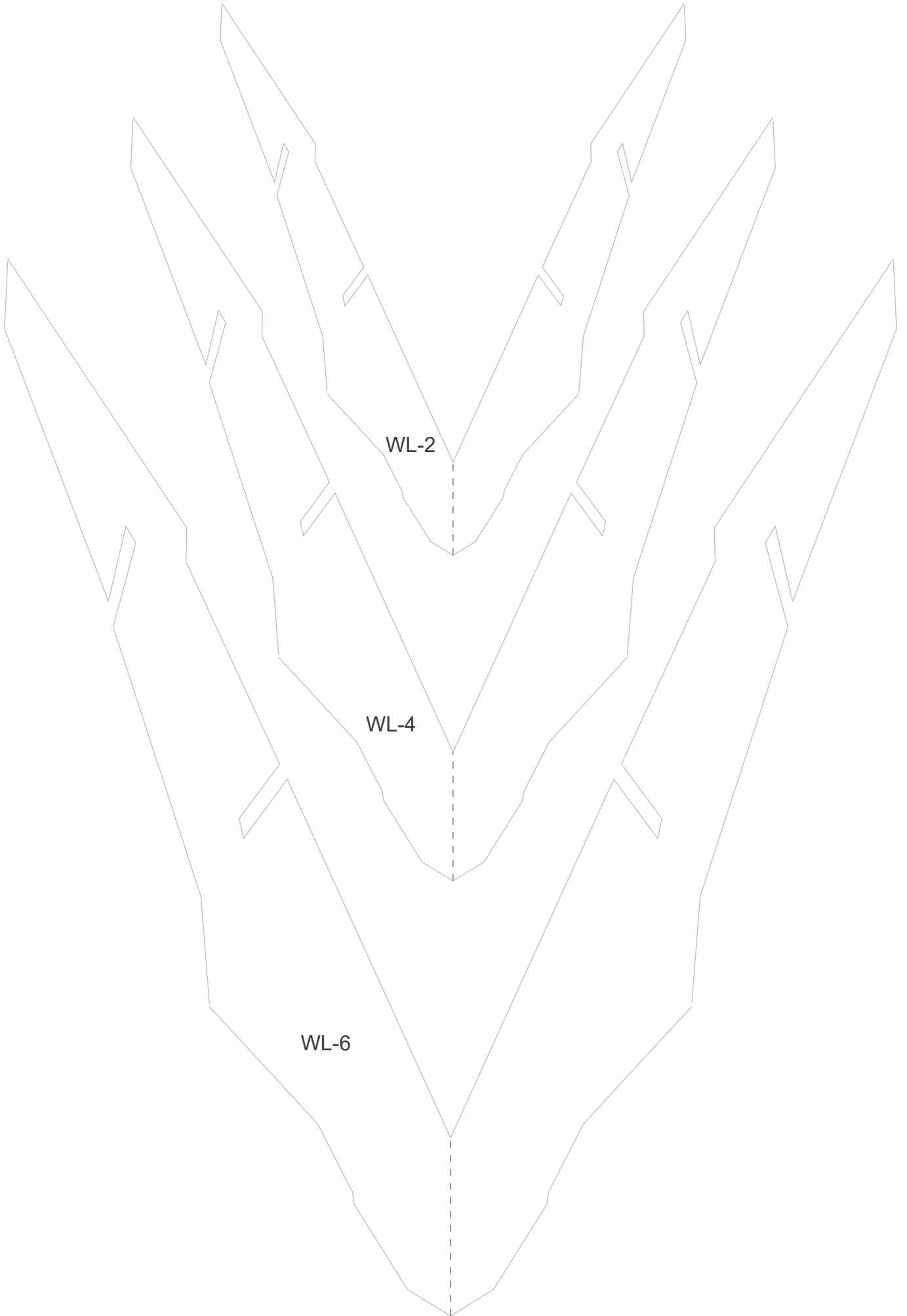

WL-2

WL-4

WL-6

