

International Overview Training: Post-2017 Tax Reform

Topic II Tax Reform Changes to International Tax Provisions



**Large Business
& International**

IRS Front Matter Items

- The IRS Mission Statement
- 14 General Principles of Ethical Conduct for Federal Employees
- Your Rights as a Taxpayer

Learning Objectives

At the end of this lesson, you will be able to:

- A. Identify the international provisions changed by 2017 US tax reform, commonly referred to as the Tax Cuts and Jobs Act (TCJA)
- B. Identify the elements of the updated International Matrix for TCJA, including strategic priorities
- C. Locate the International Knowledge Base



A-1. TCJA International Provisions: Overview



**Large Business
& International**

Tax Systems Overview

- In a **worldwide system of taxation**, a jurisdiction imposes tax on its residents on all income earned both at home or abroad. Double taxation is mitigated by foreign tax credits (FTCs). Taxpayers may pay residual tax on foreign income if the foreign tax rate is less than the domestic tax rate.
- In a **territorial system of taxation**, a jurisdiction imposes tax only on income earned at home. The hallmark of territoriality is a participation exemption, or dividends received deduction (DRD), for foreign dividends. No domestic tax on foreign income.

Tax Systems Overview (Cont'd)

- Most jurisdictions have a **hybrid system** with components of both worldwide and territorial systems. For example, most territorial systems tax certain types of foreign income via anti-deferral or subpart F-like rules and also tax foreign income earned by branches.

Overview of Pre-TCJA US Tax System

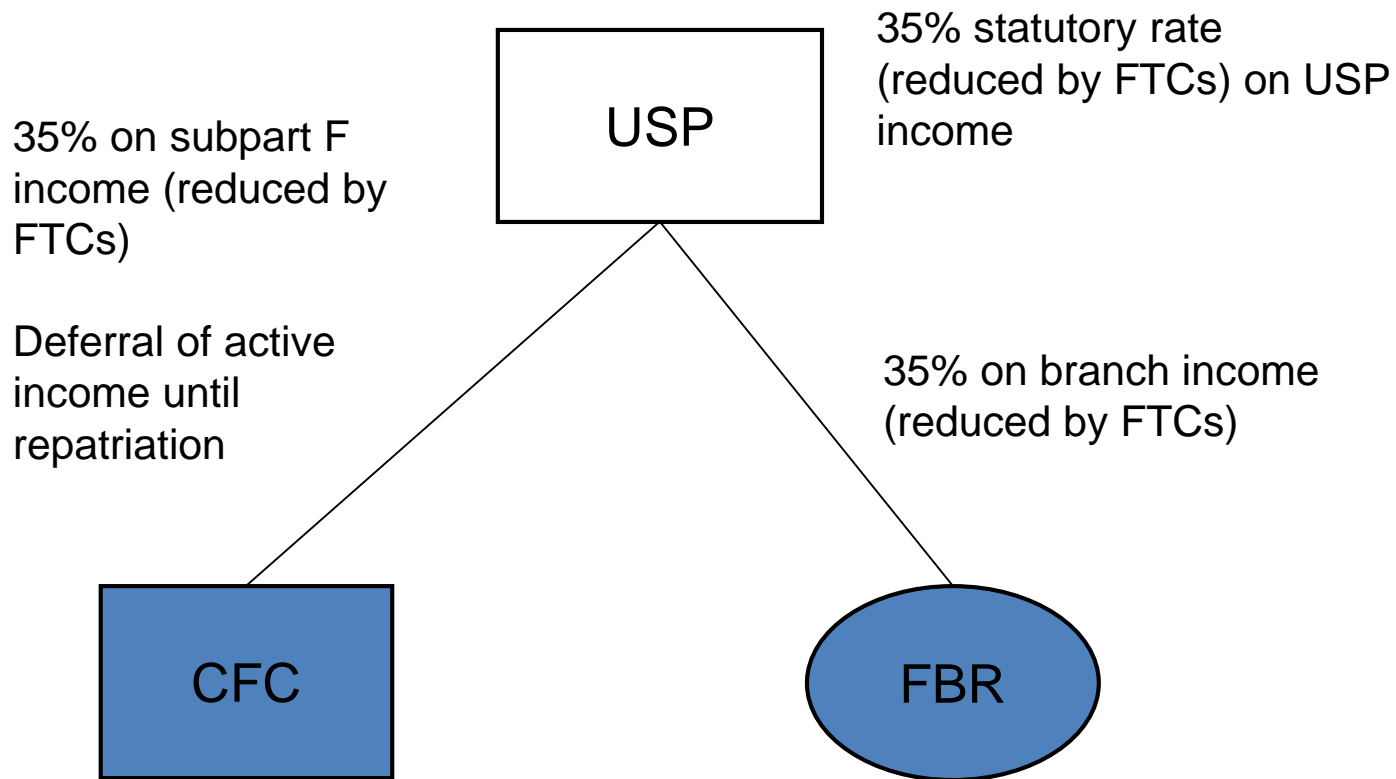

TCJA Overview

- On December 22, 2017, the President signed H.R. 1: An Act to provide for reconciliation pursuant to titles II and V of the concurrent resolution on the budget for fiscal year 2018, commonly known as TCJA
- TCJA lowered the statutory C corporation tax rate to 21% and made significant changes to the US international tax system

TCJA International Changes

- One-time transition tax on untaxed earnings of certain foreign corporations
- Exemption of foreign dividends, using 100% DRD, also known as the participation exemption
- Subpart F retained full and immediate taxation of certain mobile controlled foreign corporation (CFC) income; however, new tax at reduced rate on other CFC income, known as Global Intangible Low-Taxed Income or GILTI

TCJA International Changes (Cont'd)

- Reduced rate on income derived from foreign activities of a US corporation, known as Foreign-Derived Intangible Income or FDII
- Minimum tax on deductible payments made by US corporations to related foreign persons, known as Base Erosion and Anti-Abuse Tax or BEAT
- Disallowance of deductions related to hybrid instruments and transactions

Overview of Post-TCJA US Tax System

Payments from USP to foreign related parties subject to BEAT

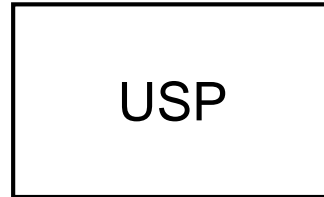

21% statutory rate (reduced by FTCs) on USP income other than, FDII, which is taxed at 13.125%*

21% on subpart F income (reduced by FTCs)

10.5%* on GILTI (partially reduced by FTCs, but new basket)

100% DRD for residual

21% on branch income (reduced by FTCs, but new basket)

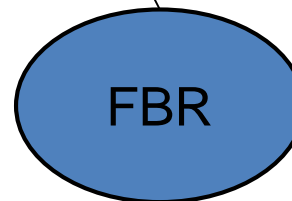

* Effective tax rate resulting from deduction

Overview of Post-TCJA US Tax System

Effective Tax Rates on Outbound Activities

	USP Income from Foreign Corporations				USP Income Earned Directly		
IRC	Participation Exemption	GILTI	Subpart F	Transition Tax	FDII	Foreign Branch	Other Income
Rate	0%	10.5%	21%	8% or 15.5%	13.125%	21%	21%
FTCs	No FTCs	FTCs (haircut), but separate FTC basket, and no carry-forward or carryback	FTCs	FTCs (haircut)	FTCs	FTCs, but separate FTC basket	FTCs

Overview of Post-TCJA US Tax System

- Worldwide components of TCJA: GILTI, subpart F
- Territorial components of TCJA: participation exemption
- New US tax system has been described by some as “taxed now or never” – *now* under GILTI/subpart F, *never* under participation exemption

Overview of Post-TCJA US Tax System (Cont'd)

Conclusion:

With the enactment of the TCJA, the US system remains a hybrid, although it has shifted away significantly from a worldwide system (with deferral) and toward a territorial system.



A-2. TCJA International Provisions: Participation Exemption



**Large Business
& International**

Participation Exemption

- Generally, dividends from a foreign corporation to a US shareholder are subject to US tax
 - Before TCJA, the DRD applied on the domestic-source (but not foreign-source) portion of such dividends under IRC 245
- TCJA enacted a participation exemption system under which foreign-source earnings of a foreign corporation can be repatriated to a corporate US shareholder without US tax
 - 100% DRD for the foreign-source portion of dividends from certain foreign corporations to certain 10% vote or value corporate US shareholders under IRC 245A
 - Domestic corporate shareholder cannot be a REIT, RIC, or S corporation
 - Effective for dividends paid after Dec. 31, 2017

Participation Exemption (Cont'd)

\$50 245A DRD

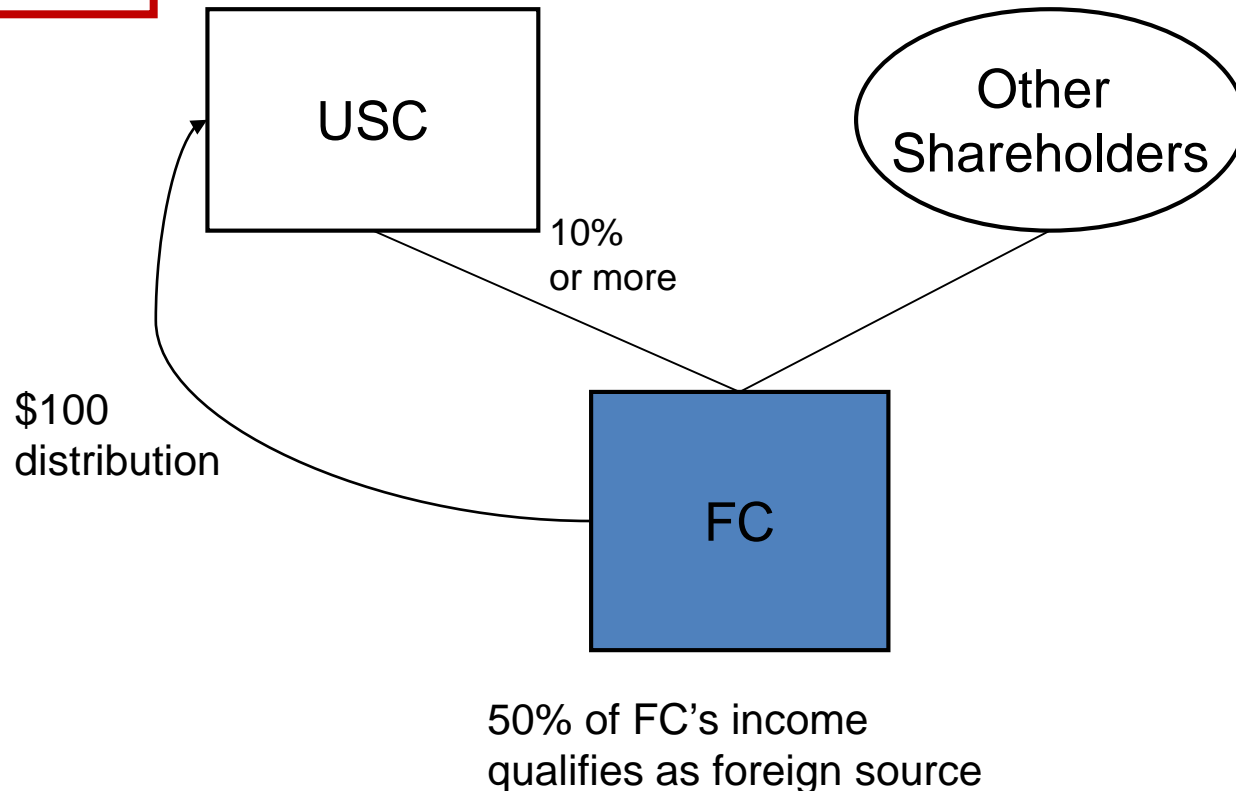

Participation Exemption (Cont'd)

- No deemed paid foreign tax credit or deduction for foreign taxes paid or accrued by the CFC with respect to E&P for which the DRD is allowed
- DRD not available for hybrid dividends
 - Amount received from a CFC for which the CFC received a deduction or other tax benefit related to taxes imposed by a foreign country
 - Dividend from lower-tier CFC to upper-tier CFC is treated as subpart F income

Participation Exemption (Cont'd)

No 245A DRD

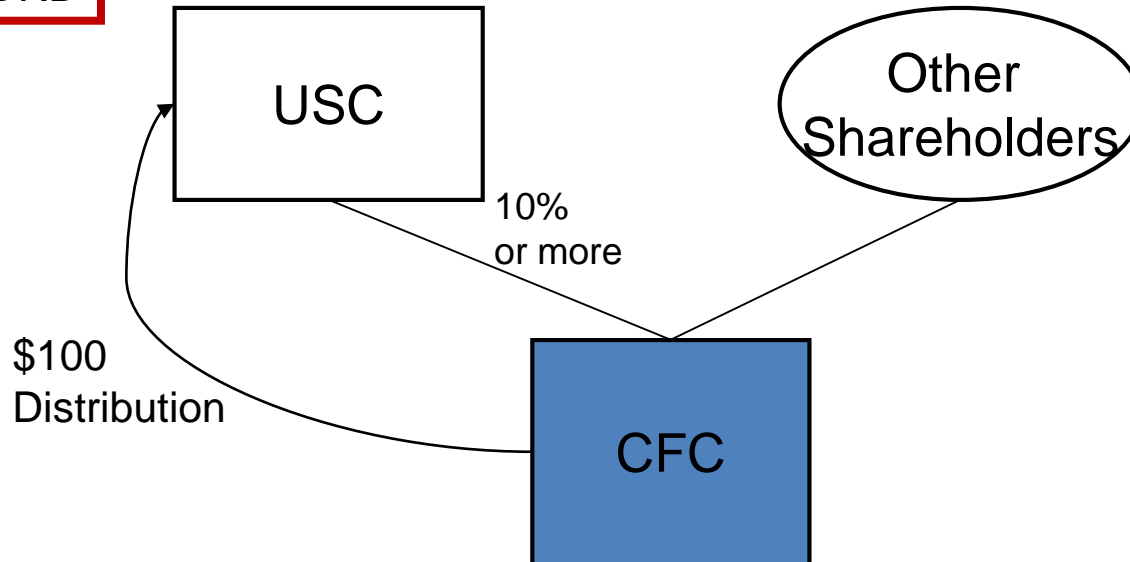

100% of CFC's income qualifies as foreign source;
CFC is entitled to a deduction for the distribution under local law

Participation Exemption (Cont'd)

- In addition to actual dividends, investments in US property by a CFC are substantially equivalent to dividends and therefore are taxed under subpart F
- With the enactment of the participation exemption, certain actual dividends are not taxed but income inclusions from investments in US property remain subject to tax
- To maintain symmetry, Treasury and the IRS issued regulations to not tax such inclusions to the extent that such inclusions would not be taxed if the amount was received as an actual dividend

Other TCJA Changes Related to Participation Exemption

- Rules providing that gain from the sale or exchange of foreign corporation stock that is treated as a dividend is eligible for participation exemption (IRC 1248(j))
 - Similar rules apply with respect to the sale by a CFC of a lower-tier CFC (IRC 964(e)(4))
- Rules providing basis adjustment for foreign corporation stock upon sale (IRC 961(d))
- Effective after Dec. 31, 2017



A-3. TCJA International Provisions: Transition Tax



**Large Business
& International**

Transition Tax

- Participation exemption would permit certain untaxed foreign earnings to be distributed to certain corporate US shareholders without being subject to US tax
- To transition to the participation exemption regime, TCJA enacted a tax on certain previously untaxed foreign earnings of certain foreign corporations with US shareholders under IRC 965

Transition Tax (Cont'd)

- This transition tax is effectuated by increasing the subpart F income of a specified foreign corporation (SFC) for its last tax year beginning before Jan. 1, 2018 by the greater of certain of its post-1986 earnings and profits (E&P) as of:
 - November 2, 2017 (which is the date that TCJA was introduced in the House), or
 - December 31, 2017

Transition Tax: Calculation

- A US shareholder of an SFC must include in its income the pro rata share of accumulated post-1986 deferred foreign income of the SFC for the last taxable year of the SFC beginning before January 1, 2018, and the amount required to be included in income is reported on the US shareholder's return for the taxable year in which or with which its SFC's taxable year ends
 - An SFC is a CFC or a foreign corporation with respect to which one or more domestic corporations is a US shareholder (at least 10% voting power)
 - Accumulated post-1986 deferred foreign income includes the post-1986 earnings and profits of an SFC, with some exceptions
 - Post-1986 earnings and profits are determined by only taking into account periods during which a foreign corporation was an SFC
 - A deficit in the post-1986 E&P of one or more SFCs of a US shareholder generally may offset the accumulated post-1986 deferred foreign income of the US shareholder's SFCs that have a positive E&P balance

Transition Tax: Rate

- US shareholder with an inclusion under IRC 965 allowed a participation deduction intended to result in the inclusion being taxed at a 15.5% rate to the extent attributable to the US shareholder's aggregate foreign cash position (generally, the sum of its pro rata shares of its SFCs' cash positions), and at 8% otherwise
 - SFC's cash position consists of cash, net accounts receivable, and the FMV of the cash-equivalent assets held by the SFC
- Reduced foreign tax credit applies to the inclusion to mirror the reduced tax rates applied pursuant to the participation deduction

Transition Tax: Rate (Cont'd)

- Tax is due with the US shareholder's return for the taxable year in which or with which its SFC's last taxable year beginning before January 1, 2018 ends, unless an election is timely made

Transition Tax: Deferral Elections

- US shareholders and owners of domestic pass-through entities that are US shareholders may elect to pay the transition tax in interest-free installments over 8 years
 - 8% of the tax due in each of the first 5 years, 15% due in year 6, 20% due in year 7, and 25% due in year 8
 - Tax deferred may be due sooner if an acceleration event occurs, but in some cases, an acceleration event will not accelerate payment of the tax if a transfer agreement is timely filed
- Shareholders of S corporations that are US shareholders may elect to defer payment of the transition tax indefinitely until a triggering event occurs
 - In some cases, a triggering event will not accelerate payment of the tax if a transfer agreement is timely filed
 - If a triggering event occurs and continued deferral is not possible, the US shareholder may elect to pay the tax over 8 years



Transition Tax: Additional Resources

- Answers to questions related to IRC 965 that are not covered in the final regulations may be found here:
 - “Questions and Answers about Reporting Related to Section 965 on 2017 Tax Returns,” *available at* <https://www.irs.gov/newsroom/questions-and-answers-about-reporting-related-to-section-965-on-2017-tax-returns>
 - “Questions and Answers about Tax Year 2018 Reporting and Payments Arising under Section 965,” *available at* <https://www.irs.gov/newsroom/questions-and-answers-about-tax-year-2018-reporting-and-payments-arising-under-section-965>

Recap

- TCJA enacted significant changes to the US international tax system
- US tax system remains a hybrid with elements of worldwide and territorial tax systems
- TCJA international provisions covered so far:
 - Participation exemption
 - Transition tax
- More TCJA international overview to come:
 - GILTI
 - FDII
 - BEAT
 - Hybrids and others

International Overview Training: Post-2017 Tax Reform

Topic II Tax Reform Changes to International Tax Provisions Day 2



**Large Business
& International**

Welcome Back and Overview

- TCJA lowered the statutory C corporation tax rate to 21% and made significant changes to the US international tax system
- TCJA international provisions covered:
 - Participation exemption
 - Transition tax
- Today we will continue with overview of TCJA international provisions
- Identify the elements of the updated International Matrix
- Navigate to the International Knowledge Base



A-4. TCJA International Provisions: Foreign Tax Credits



**Large Business
& International**

Deemed Paid Foreign Tax Credit

- Before TCJA, a 10% corporate US shareholder of a foreign corporation was deemed to have paid a portion of the foreign corporation's foreign income tax under IRC 902 when it received a dividend from that foreign corporation
- Because such dividends are now eligible for a 100% DRD, TCJA repeals this deemed paid foreign tax credit
- Effective for tax years of foreign corporations beginning after 2017 and to tax years of US shareholders with or within which such tax years of foreign corporations end

Deemed Paid Foreign Tax Credit (Cont'd)

- TCJA retains a deemed-paid credit for subpart F inclusions and extends it to GILTI inclusions (IRC 960(a) and (d))
- TCJA modifies this credit so that allowable credit based on current-year taxes attributable to subpart F income rather than a multi-year pooling approach
- TCJA also provides rules applicable to foreign taxes attributable to distributions of previously taxed income
- Effective for tax years of foreign corporations beginning after 2017 and to tax years of US shareholders with or within which such tax years of foreign corporations end

Other Foreign Tax Credit Changes

- TCJA creates a separate foreign tax credit limitation basket for foreign branch income (IRC 904(d)(1)(B)) and GILTI income (IRC 904(d)(1)(A))
- TCJA repealed the fair market value method of valuing assets for purposes of interest expense apportionment under IRC 864(e)(2); now, tax basis must be used in all cases
- Dividends eligible for IRC 245A DRD are not treated as exempt, but under IRC 904(b)(4), expenses apportioned to dividends are added back in computing the IRC 904 FTC limitation

Other Foreign Tax Credit Changes (Cont'd)

- TCJA also allows taxpayers to elect to recapture overall domestic loss accounts more quickly and recharacterize US source income as foreign source income (IRC 904(g)(5))
- TCJA modifies the sourcing of income from sales of taxpayer-produced inventory to be based solely on place of production (IRC 863(b))
- Effective for taxable years beginning after Dec. 31, 2017



A-5. TCJA International Provisions: Global Intangible Low-Taxed Income



**Large Business
& International**

Global Intangible Low-Taxed Income, or GILTI

- Introduction of a new participation exemption system without base protection measures could incentivize taxpayers to allocate income to CFCs operating in low-tax or zero-tax jurisdictions
- TCJA retained full and immediate taxation of certain passive and mobile CFC income (subpart F income)
- TCJA enacts new IRC 951A, known as GILTI, to subject other CFC income to current taxation
- TCJA also enacted a deduction for certain US shareholders to reduce the rate of tax on GILTI

GILTI Calculation

- GILTI calculation applies a formulaic approach to subject income above a “normal return” to current taxation
- Unlike subpart F, GILTI is determined at US shareholder level
- US shareholder does not compute a separate GILTI inclusion amount with respect to each CFC but instead computes a single GILTI inclusion amount by reference to all of its CFCs

GILTI Calculation (Cont'd)

- GILTI inclusion amount begins with the calculation of certain items of each CFC
 - **Tested income or tested loss** determined at each CFC, and **pro rata share** of tested income or tested loss flows up to each US shareholder and netted at US shareholder level to determine US shareholder's **net CFC tested income**
 - **Qualified business asset investment (QBAI)** and interest expense determined at each CFC, and pro rata share of QBAI from tested income CFCs and interest expense flows up to each US shareholder to determine US shareholder's QBAI and interest expense
 - **Net deemed tangible income return (net DTIR)** is 10% of QBAI less certain interest expense
 - Net CFC tested income less net DTIR equals GILTI

GILTI Calculation: Tested Income

Net CFC Tested Income = \$400
(\$600 - \$200)

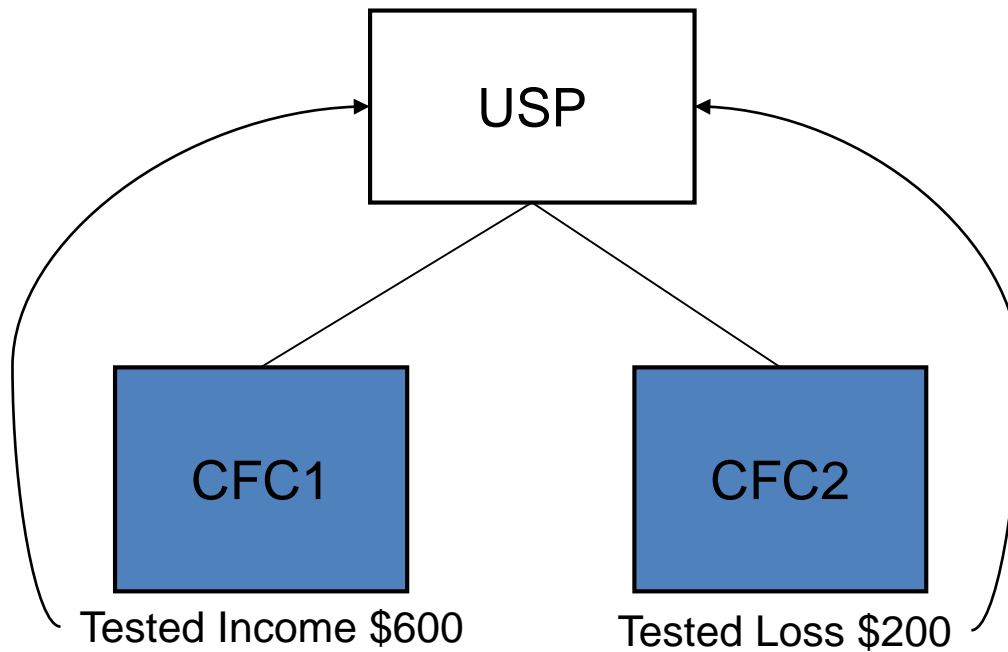

GILTI Calculation: Net DTIR

$$\text{Net DTIR} = 10\% \times \$100 = \$10$$

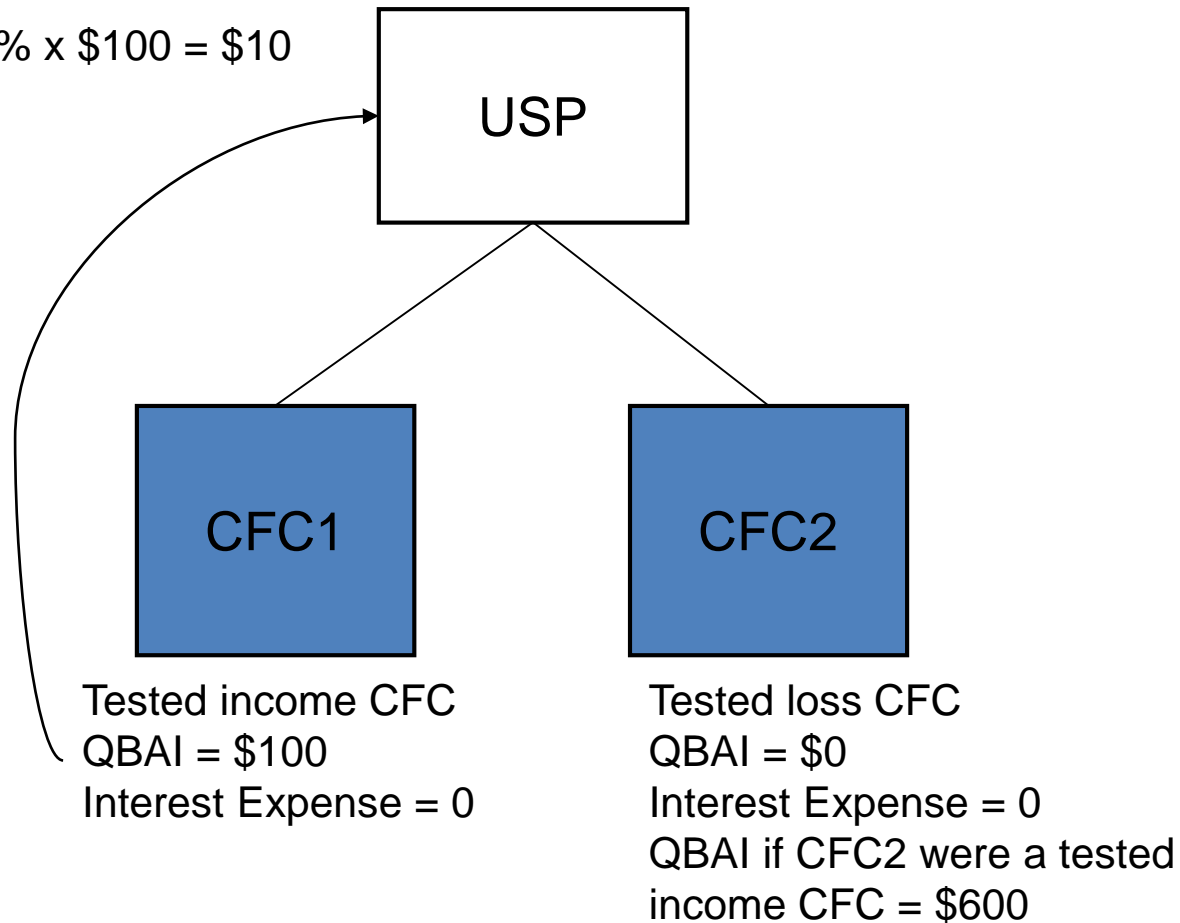

GILTI Calculation: Results

Net CFC tested income = 400

Net DTIR = 10% x \$100 = \$10

GILTI = Net CFC tested income less Net DTIR

GILTI = \$400 - \$10

GILTI = \$390

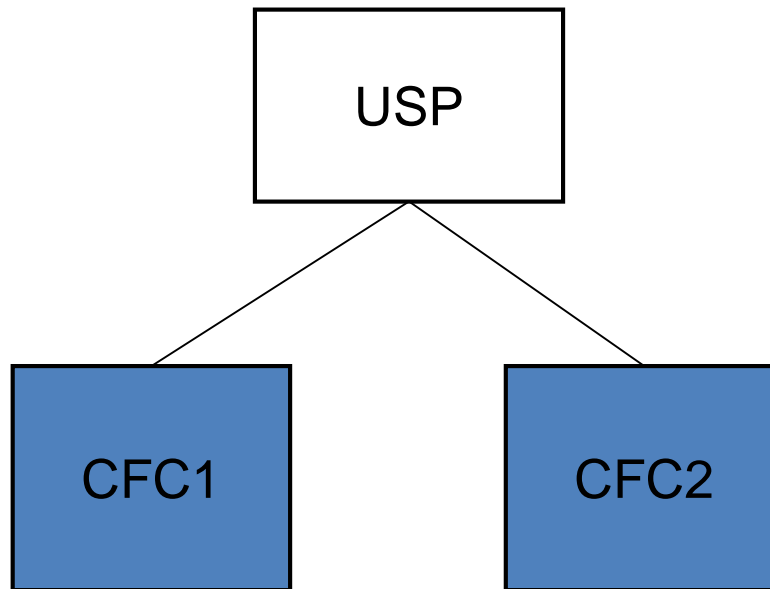

GILTI Income Inclusion and Deduction

- GILTI amount included currently in US shareholder's income
- Corporate US shareholders are generally allowed a deduction equal to 50% of GILTI and IRC 78 gross-up with respect to GILTI for 2018-2025 (37.5% of GILTI starting in 2026)
- Individual US shareholders not allowed deduction
 - US individuals can elect under IRC 962 to be subject to tax at corporate rates, including on GILTI under proposed regulations. Electing US individual shareholders are still subject to tax at individual rates when earnings are distributed.
- Deduction discussed further in next section



GILTI FTCs

- TCJA provides a deemed paid credit of 80% of foreign taxes attributable to tested income under IRC 960(d)
- Separate foreign tax credit basket so that these taxes are not credited against US tax imposed on other foreign-source income
- No carryforward or carryback of taxes in GILTI basket

GILTI

- Effective for tax years of foreign corporations beginning after Dec. 31, 2017, and for tax years of US shareholders in which or with which such tax years of foreign corporations end
- Regulations include **anti-abuse rules** for taxpayers with fiscal year-end CFCs that entered into transactions or arrangements with other CFCs, before GILTI applied, that would have allowed them
 - to transfer assets, including intangible assets like intellectual property, to a related party without having to include in tested income any gains realized and
 - to create basis that the taxpayer would then depreciate or amortize (the taxpayer would use these deductions to reduce tested income, or create or increase a tested loss).



A-6. TCJA International Provisions: Deduction for GILTI and FDII



**Large Business
& International**

Deduction for GILTI and Foreign-Derived Intangible Income, or FDII

- TCJA enacted new IRC 250, which provides corporate deductions on the sum of GILTI and FDII subject to a taxable income limitation
- Purpose of GILTI Deduction: To avoid a negative impact on the competitiveness of US multinationals relative to their foreign peers from taxing the GILTI inclusion amount at the full US tax rate, TCJA provides a 50% deduction with respect to GILTI and the related IRC 78 gross-up with respect to GILTI
 - 50% of GILTI for 2018-2025, 37.5% of GILTI starting in 2026

Deduction for FDII and GILTI (Cont'd)

- Purpose of FDII Deduction: To neutralize the effect of providing a deduction with respect to GILTI earned by a domestic corporation through a CFC, TCJA also provides a corresponding deduction for certain foreign-derived income, known as foreign derived intangible income, or FDII, earned directly by the domestic corporation
 - 37.5% of FDII for 2018-2025, 21.875% of FDII starting in 2026
- Overall Purpose of IRC 250 Deduction: To neutralize the role tax considerations play in the location of income attributable to foreign activity
- Effective for taxable years beginning after Dec. 31, 2017

Deduction for FDII and GILTI (Cont'd)

- Deductions available to domestic corporation
 - US individuals can elect under IRC 962 to be subject to tax at corporate rates and may claim GILTI deduction (US individuals still subject to shareholder-level tax on distribution)
 - Deduction not available for S corporations or RICs or REITs
- If, for any taxable year, the sum of a domestic corporation's FDII and GILTI deductions exceed its taxable income, the excess is allocated pro rata to reduce the corporation's FDII and GILTI solely for purposes of computing deduction

FDII Deduction

- FDII calculation applies a formulaic approach to determine deduction amount
- FDII amount is generally the amount of net income above a “normal return” attributable to (1) property sold to foreign persons or (2) services provided to a person, or with respect to property, outside the US
 - Normal return determined based on 10% of QBAI similar to determination under GILTI
 - Special rules for related party sales and services

FDII Deduction (Cont'd)

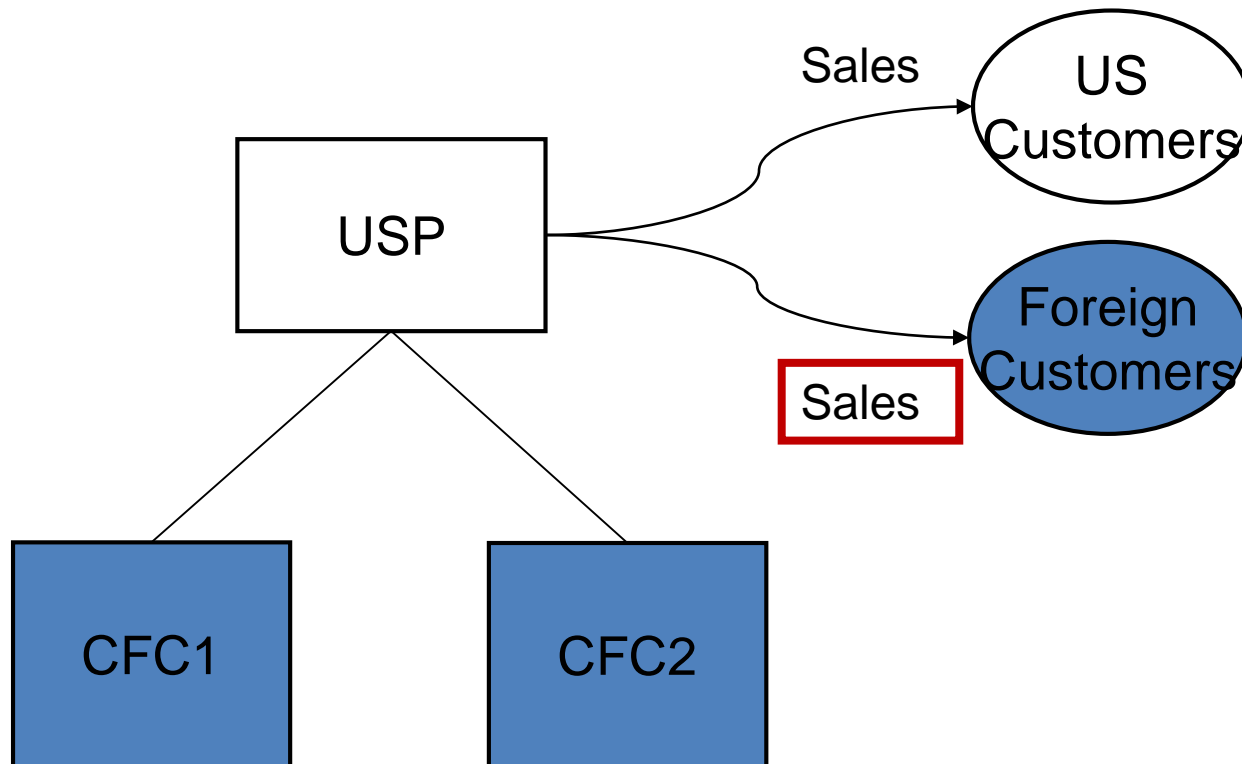



A-7. TCJA International Provisions: Base Erosion and Anti-Abuse Tax



**Large Business
& International**

Base Erosion and Anti-Abuse Tax, or BEAT

- TCJA enacted a new tax under IRC 59A, known as BEAT
- BEAT applies to a domestic corporation (1) that is part of a group with at least \$500 million of annual domestic gross receipts over a three-year averaging period and (2) that has a “base erosion percentage” of 3% (2% for certain banks and securities dealers) or higher for the tax year
 - Generally, the base erosion percentage is the percentage determined by dividing the aggregate “base erosion tax benefits” for the taxable year by the aggregate deductions for the taxable year (including “base erosion tax benefits”)
 - Applies also to a foreign corporation engaged in a US trade or business for purposes of determining its effectively connected income tax liability
 - Not applicable to S corporations, RICs, or REITs

BEAT: Calculation

- To calculate BEAT, an applicable taxpayer calculates its regular US tax at 21% rate (reduced by certain credits) and then calculates its base erosion minimum tax amount, which is determined by multiplying the applicable taxpayer's "modified taxable income" amount by the BEAT rate
 - Modified taxable income is the applicable taxpayer's taxable income plus certain deductible payments (base erosion tax benefits) and a certain percentage of any NOL deduction
 - BEAT rate is 5% for 2018, 10% for 2019-2025, and 12.5% thereafter (percentages increased by 1% for certain banks)

BEAT: Calculation (Cont'd)

- If the regular tax liability is lower than the BEAT liability, the taxpayer must pay the regular tax plus the amount by which the BEAT exceed the regular tax
- Effective for base erosion payments paid or accrued in taxable years beginning after Dec. 31, 2017

BEAT Payments

- Base erosion payments are:
 - Any amount paid by the taxpayer to a foreign related person for which a deduction is allowable
 - Any amount paid by the taxpayer to a foreign related person for the acquisition of depreciable or amortizable property
 - Reinsurance payments made to a foreign related person
 - Cost of goods sold paid to certain inverted corporations or to a member of the same expanded affiliated group as an inverted corporation
- For any base erosion payment, a base erosion tax benefit is:
 - A deduction that is allowed in the taxable year, including for depreciation or amortization
 - A reinsurance payment that either reduces premiums arising out of indemnity insurance or reduces premiums paid on reinsurance
 - A reduction to gross receipts for cost of goods sold to a inverted corporation

Exceptions to BEAT Payments

- Exceptions to payments subject to BEAT generally include:
 - Cost of the service (not including any markup) for service payments that qualify for the services cost method
 - Certain qualified derivative payments
 - Payments to a US branch of a related foreign person to the extent treated as effectively connected income
 - Exchange loss with respect to foreign currency

BEAT Payment

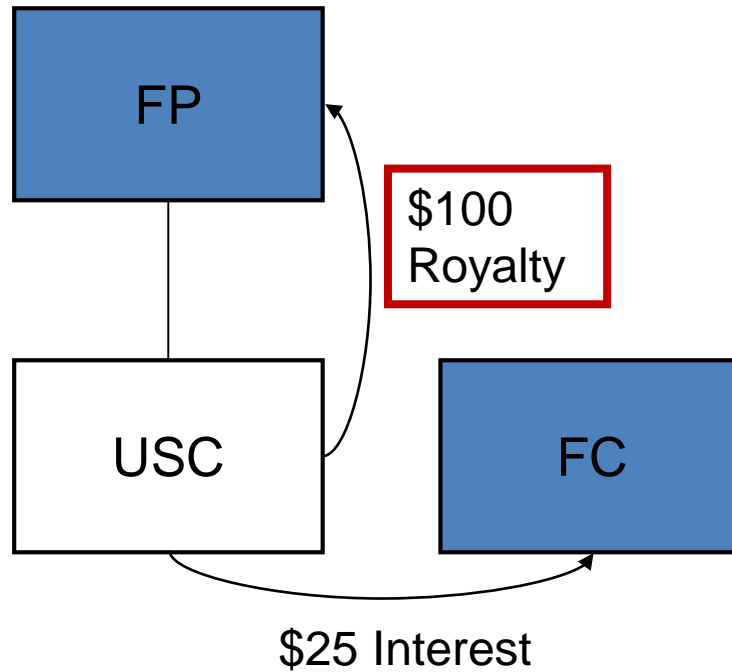



A-8. TCJA International Provisions: Hybrid Arrangements



**Large Business
& International**

Hybrids Arrangements

- Cross-border transaction may be treated differently for US and foreign tax purposes because of differences in the tax law of each country
- In general, the US tax treatment of a transaction does not take into account foreign tax law
- TCJA enacted new rules under IRC 267A to address hybrid arrangements
- Intended to be consistent with the approaches taken already in the Internal Revenue Code and tax treaties and agreed in international fora

Hybrids Arrangements (Cont'd)

- Hybrid arrangement rules disallow the deduction for an interest or royalty payment to a related party under a hybrid arrangement that gives rise to an amount that is not taxed in the recipient jurisdiction (either no income inclusion or a deduction)
 - Not including any payment to the extent included in income under subpart F
- Effective for tax years beginning after Dec. 31, 2017

Hybrid Transactions

- Hybrid transaction is generally any transaction, series of transactions, agreement, or instrument with a payment treated as interest or royalties for US federal income tax purposes but not so treated for foreign tax law purposes

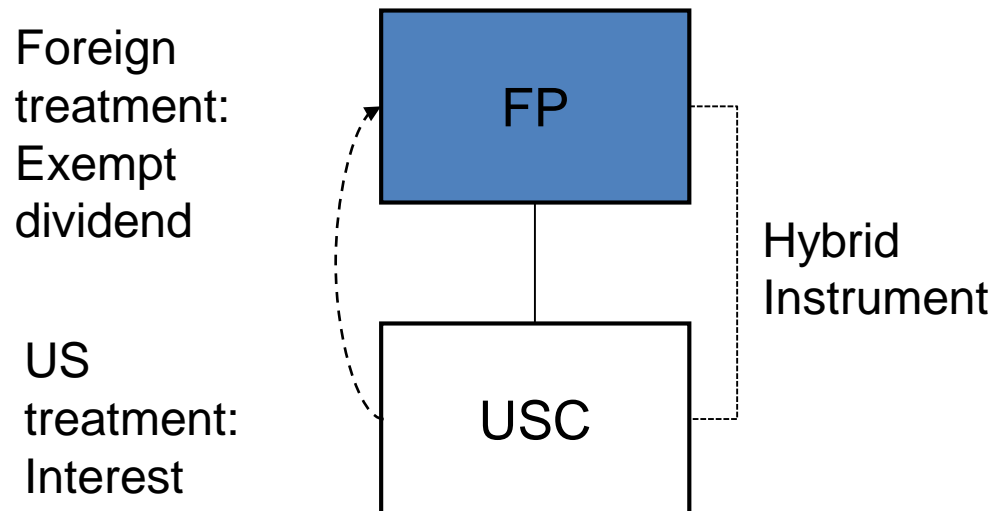

Hybrid Entities

- Hybrid entity is an entity treated as fiscally transparent for US federal income tax purposes but not for foreign tax law purposes or vice versa

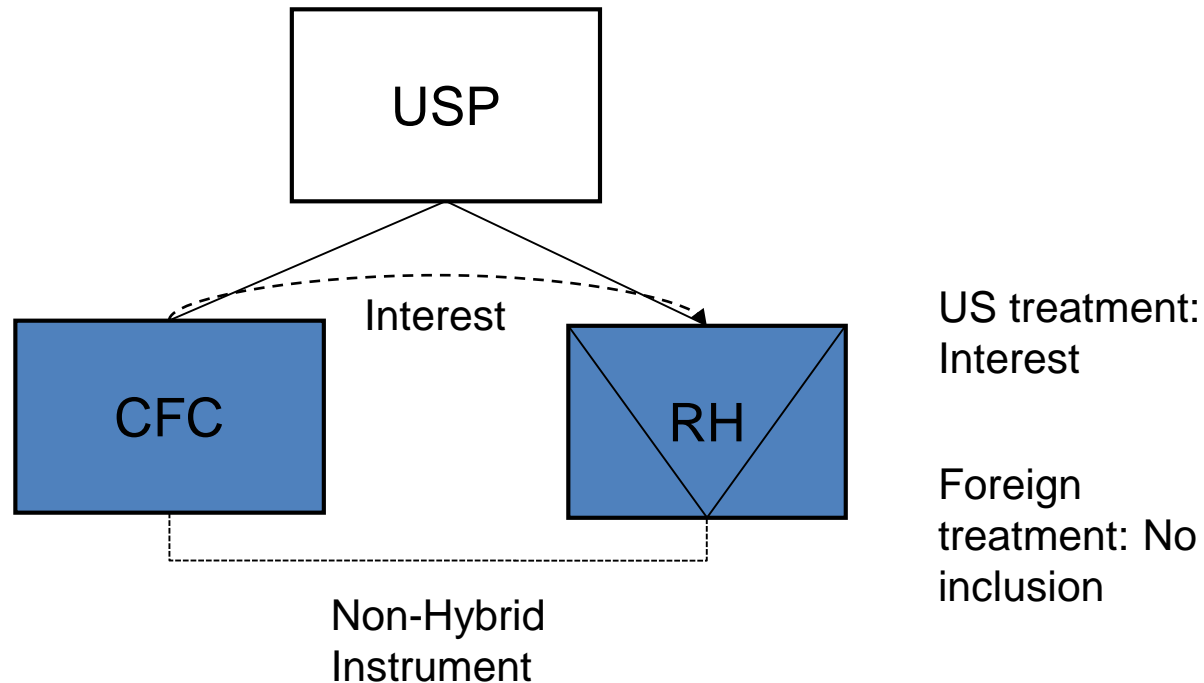



A-9. TCJA International Provisions: Recap



**Large Business
& International**

Review of Post-TCJA US Tax System

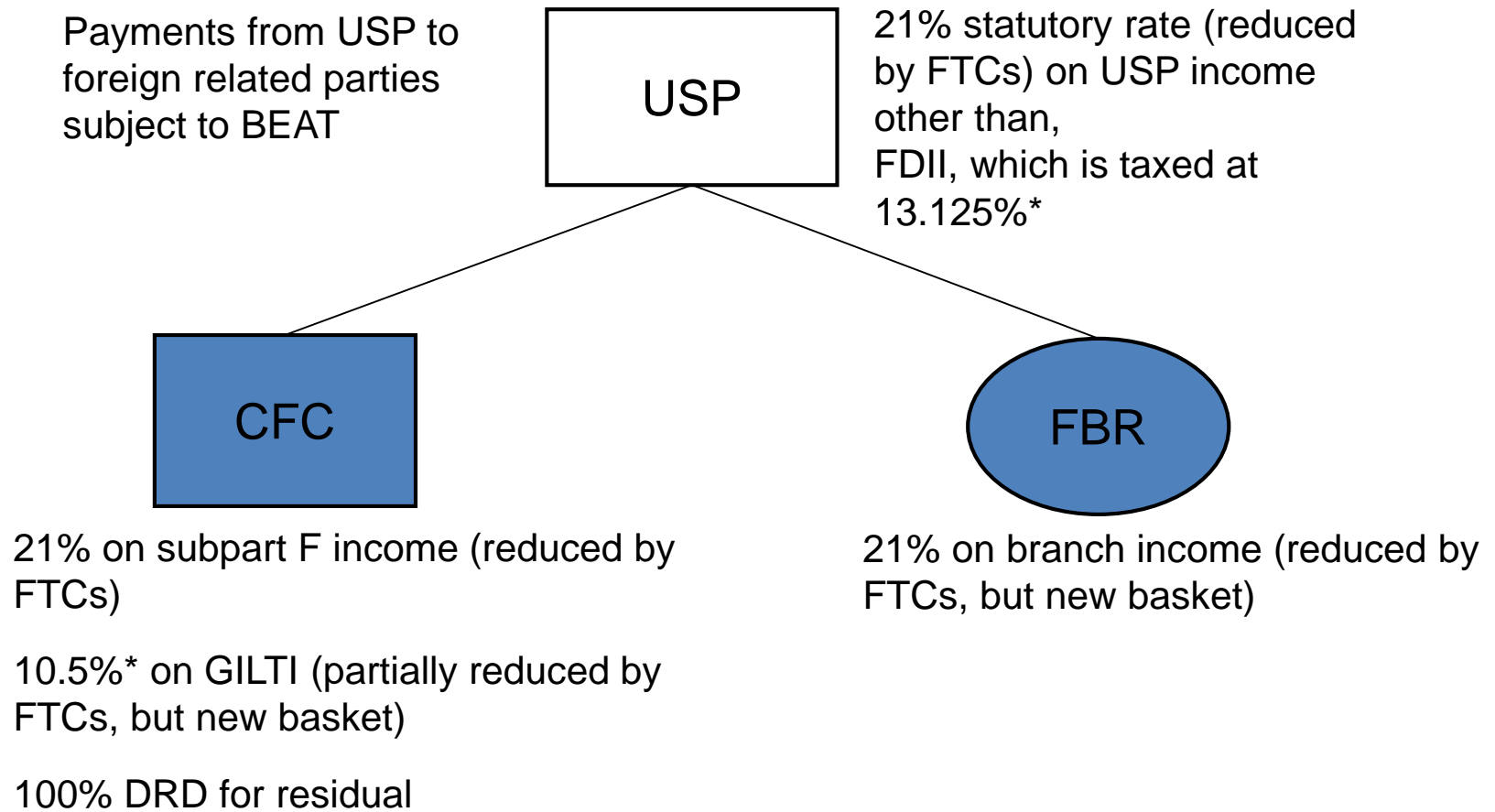

* Effective tax rate resulting from deduction

Example

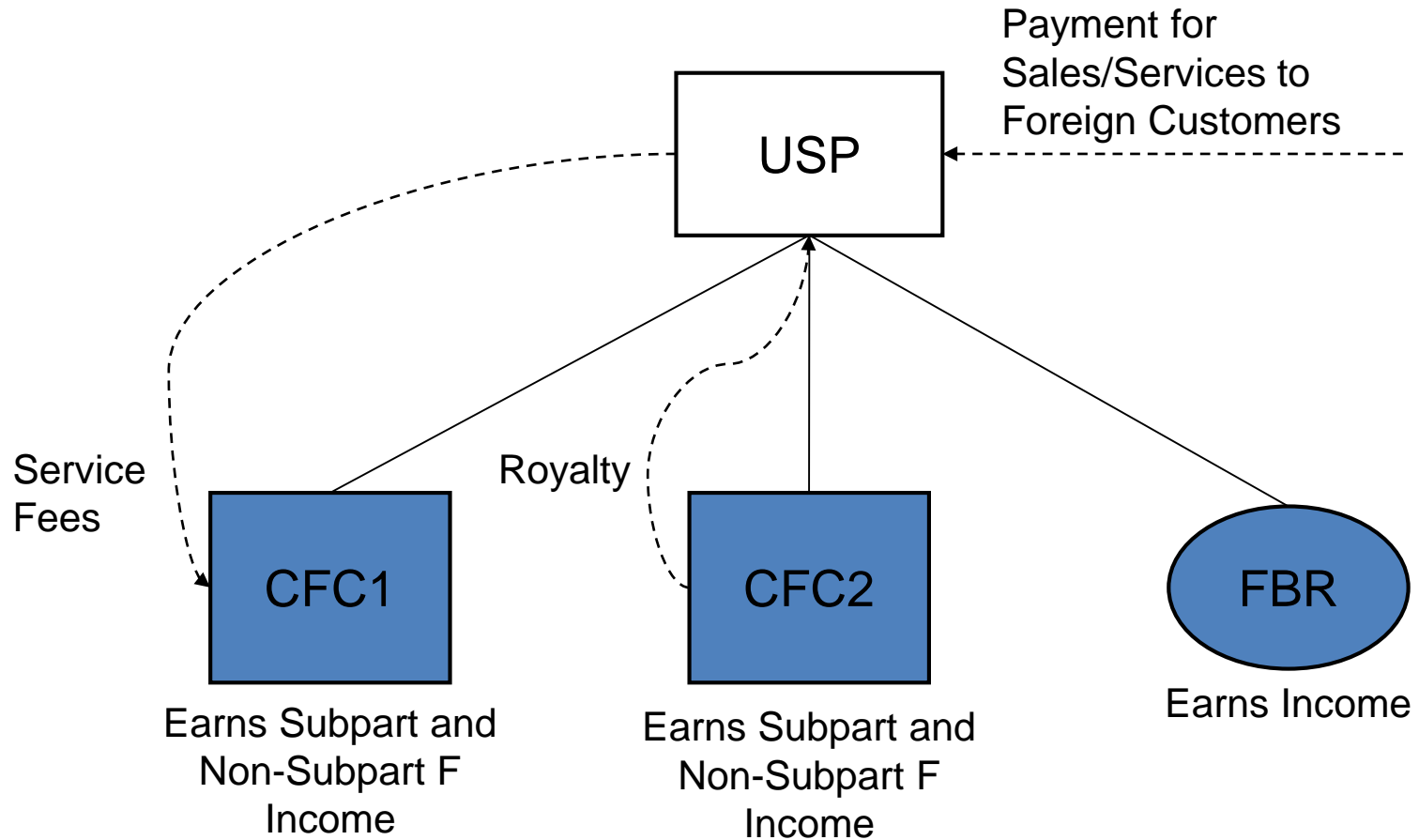

Example

What TCJA Provisions Apply?

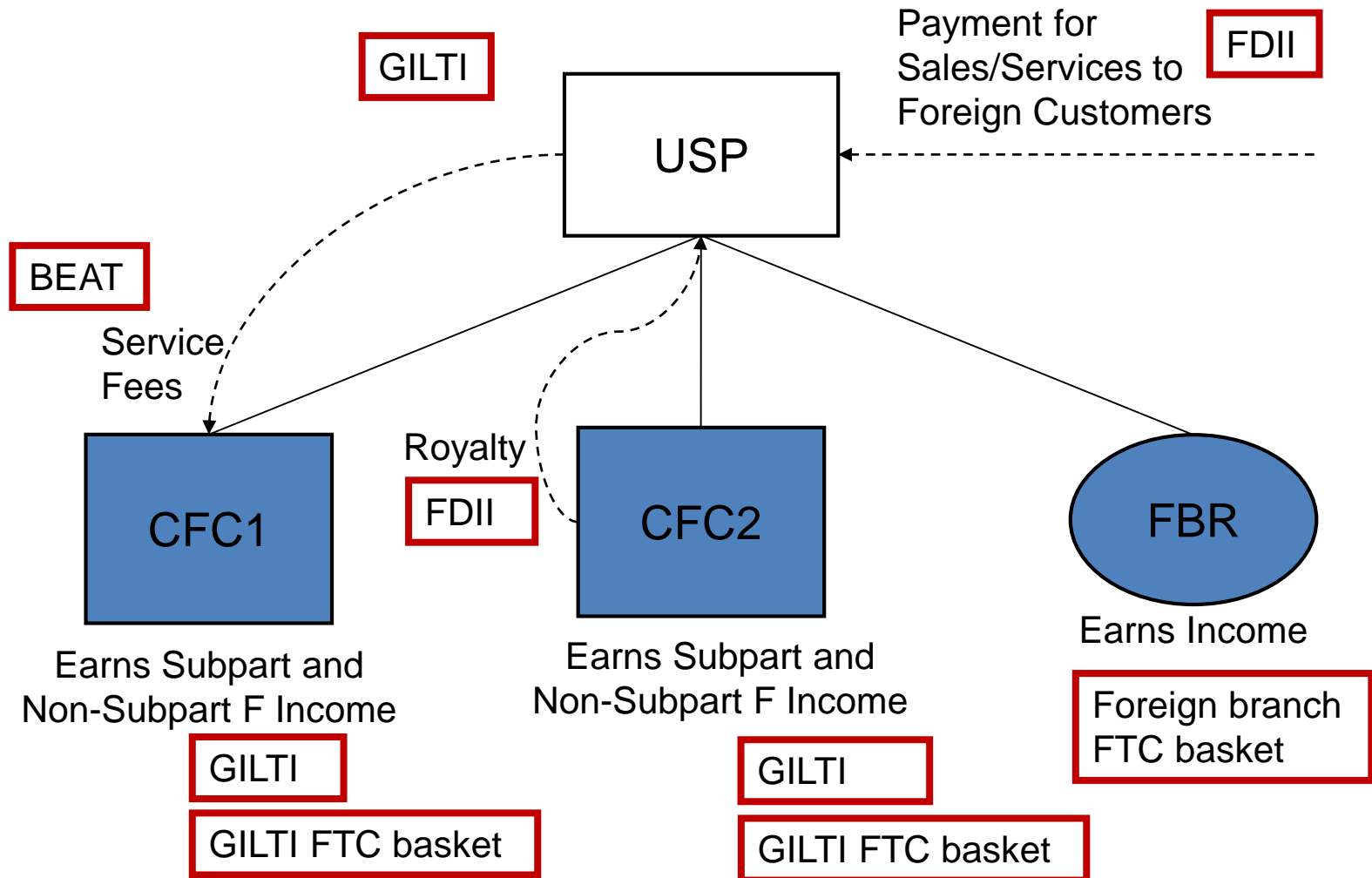



A-10. TCJA International Provisions: Other Provisions



**Large Business
& International**

Subpart F Modifications

- TCJA retained full and immediate taxation of subpart F income but enacted certain changes to these provisions
- Modification of US shareholder definition to include a US person who owns at least 10% of the value of the shares of the foreign corporation (IRC 951(b))
- Eliminates 30-day requirement for foreign corporation to constitute CFC for uninterrupted period of at least 30 days in order for a US shareholder to have a current income inclusion (IRC 951(a))
- Repeal of inclusion of foreign base company oil-related income (repeal of IRC 954(g))



Subpart F Modifications (Cont'd)

- Repeal of inclusion based on withdrawal of previously excluded subpart F income from qualified investment (repeal of IRC 955)
- Modification of stock attribution rules to permit downward attribution from a foreign person to a US person (repeal of IRC 958(b)(4))

Subpart F Modifications: Downward Attribution

FP is a widely held foreign corporation with no 10% direct or indirect US shareholders. FP owns 100% of USC1 and 90% of FC. The remaining 10% of FC is owned by an unrelated US shareholder.

Before TCJA, FC would not be a CFC. Under TCJA, FC is treated as a CFC.

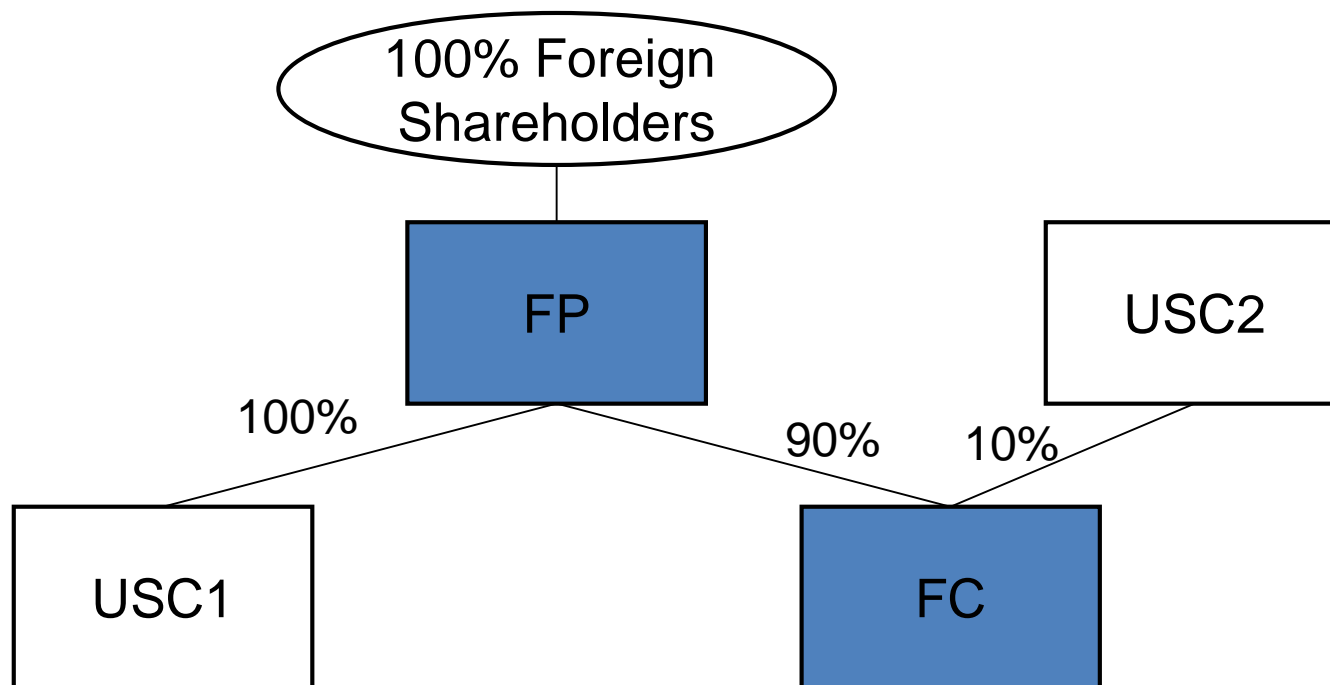

Passive Foreign Investment Company (PFIC) Insurance Exception

- Foreign corporation that is not a CFC is a PFIC if (1) 75% or more of its gross income is passive income, or (2) the average percentage of assets held by the corporation during the taxable year which produce passive income (or which are held for the production of passive income) is at least 50%
- Before TCJA, there was an exception from passive income for investment income derived from the active conduct of an insurance business

PFIC Insurance Exception (Cont'd)

- TCJA modifies this PFIC insurance exception to apply only to a foreign corporation whose applicable insurance liabilities constitute more than 25% of its total assets
 - For a corporation that cannot meet the new 25% test, there is regulatory authority to allow a US person owning stock of such foreign corporation to elect to treat it as a qualifying insurance company if (1) its applicable liabilities equal at least 10% of its assets, and (2)(a) the foreign corporation is predominantly engaged in an insurance business, and (b) the failure to satisfy the greater than 25% threshold is due solely to runoff-related or rating-related circumstance involving such insurance business
- Effective for tax years beginning after Dec. 31, 2017

Repeal of Active Trade or Business Exception

- If a US person transfers property used in the active conduct of a trade or business to a foreign corporation in a nonrecognition transaction, after TCJA, there is no longer an exception to gain recognition due to the property being used in an active trade or business (repeal of active trade or business exception of IRC 367(a)(3))
- Due to a provision eliminated in this repeal, TCJA enacted a new foreign branch loss recapture rule (IRC 91)
- Effective for transfers made after Dec. 31, 2017

Intangible Property Transfers

- TCJA clarifies the definition of “intangible property” under IRC 936(h)(3)(B) which applies for purposes of the rules on outbound transfers under IRC 367(d) and on transfer pricing transactions under IRC 482
- Definition of “intangible property” now expressly includes:
 - Goodwill,
 - Going Concern Value,
 - Workforce in place, and
 - Any other item the value or potential value of which is not attributable to tangible property or the services of any individual

Intangible Property Transfers (Cont'd)

- Consolidated Appropriations Act, 2018, includes technical tax corrections to the IRC following the TCJA
 - Struck IRC 936 in its entirety from the Code
 - In effect, moved the definition of “intangible property” under IRC 936(h)(3)(B), as just modified by the TCJA, to a new IRC 367(d)(4).
- Now, the definition of “intangible property” for purposes of both IRC 367(d) and IRC 482 is found at IRC 367(d)(4)

Intangible Property Transfers (Cont'd)

- Requires the valuation of transfers of IP (including IP transferred with other property or services), on an aggregate basis, or the valuation of such a transfer on the basis of the realistic alternatives to such a transfer, if the Secretary determines that such basis is the most reliable means of valuation of such transfers
- Both provisions effective for transfers in tax years beginning after Dec. 31, 2017

Foreign Partner with US Trade or Business

- Revenue Ruling 91-32 treated a foreign partner's capital gain or loss on the sale of a partnership interest as effectively connected with a US trade or business if, and to the extent that, the sale of the underlying assets would have resulted in effectively connected income for the foreign partner
- In 2017, the Tax Court in *Grecian Magnesite Mining v. Commissioner* refused to follow the ruling in finding that a foreign partner was not subject to US tax on the sale of a partnership interest
- TCJA enacts new IRC 864(c)(8) generally following Revenue Ruling 91-32

Foreign Partner with US Trade or Business (Cont'd)

- TCJA provides that a nonresident alien individual's or foreign corporation's gain or loss from the sale of a partnership interest is effectively connected with a US trade or business to the extent that the sale of the underlying assets at fair market value on the date of the exchange would have resulted in effectively connected income for the foreign partner
 - Effective for sales, exchanges, or other dispositions occurring on or after Nov. 27, 2017
- TCJA also enacts a 10% withholding tax on the amount realized under new IRC 1446(f)
 - Effective for sales, exchanges, or other dispositions occurring after December 31, 2017

Dividends from Surrogate Foreign Corporation

- Dividends to individuals from domestic corporations and certain foreign corporations receive a preferential tax rate under IRC 1(h)(11)
- TCJA amended new IRC 1(h)(11)(C) to provide that dividends from surrogate foreign corporations are not eligible for the preferential tax rate
- Effective for dividends received after Dec. 22, 2017 with respect to corporations that first become surrogate foreign corporations after Dec. 22, 2017

Excise Tax on Stock-Based Compensation of Expatriated Corporation

- Excise tax under IRC 4985 on certain stock-based compensation of corporate insiders when a domestic corporation becomes an expatriated corporation through an inversion transaction in which a shareholder of the domestic corporation recognizes gain
- TCJA modifies the excise tax from 15% to 20%
- Effective for corporations that first become surrogate foreign corporations after Dec. 22, 2017



B. Updated International Matrix



**Large Business
& International**

Pre-Tax Reform International Matrix

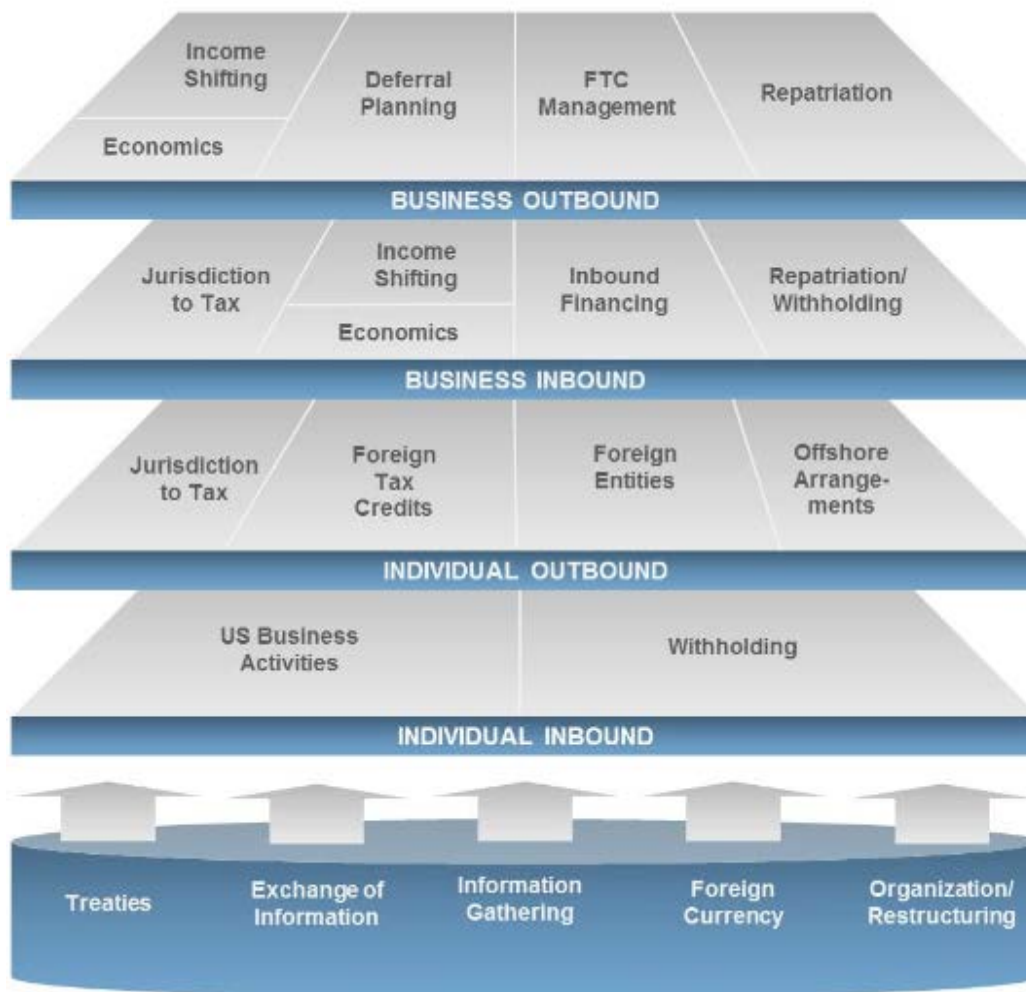

Changes to International Matrix

- International Matrix has been updated on an interim basis to reflect certain changes as a result of tax reform
- International Matrix no longer represents a life cycle of taxpayer behavior; after tax reform, taxpayers may follow different paths
- Further updates to the International Matrix are expected as Large Business & International gains experience with the tax reform changes and taxpayer behavior

Updated International Matrix

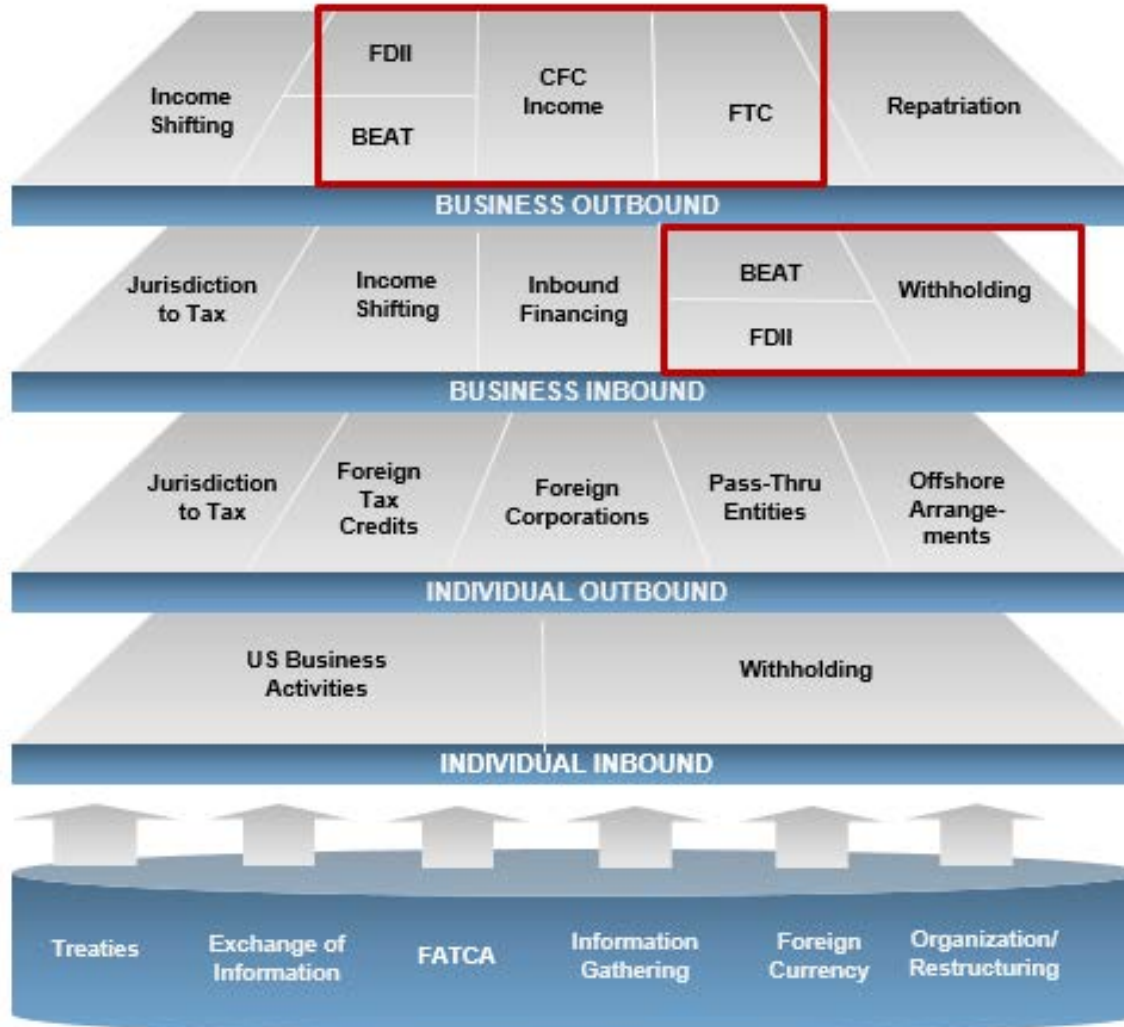

Business Outbound

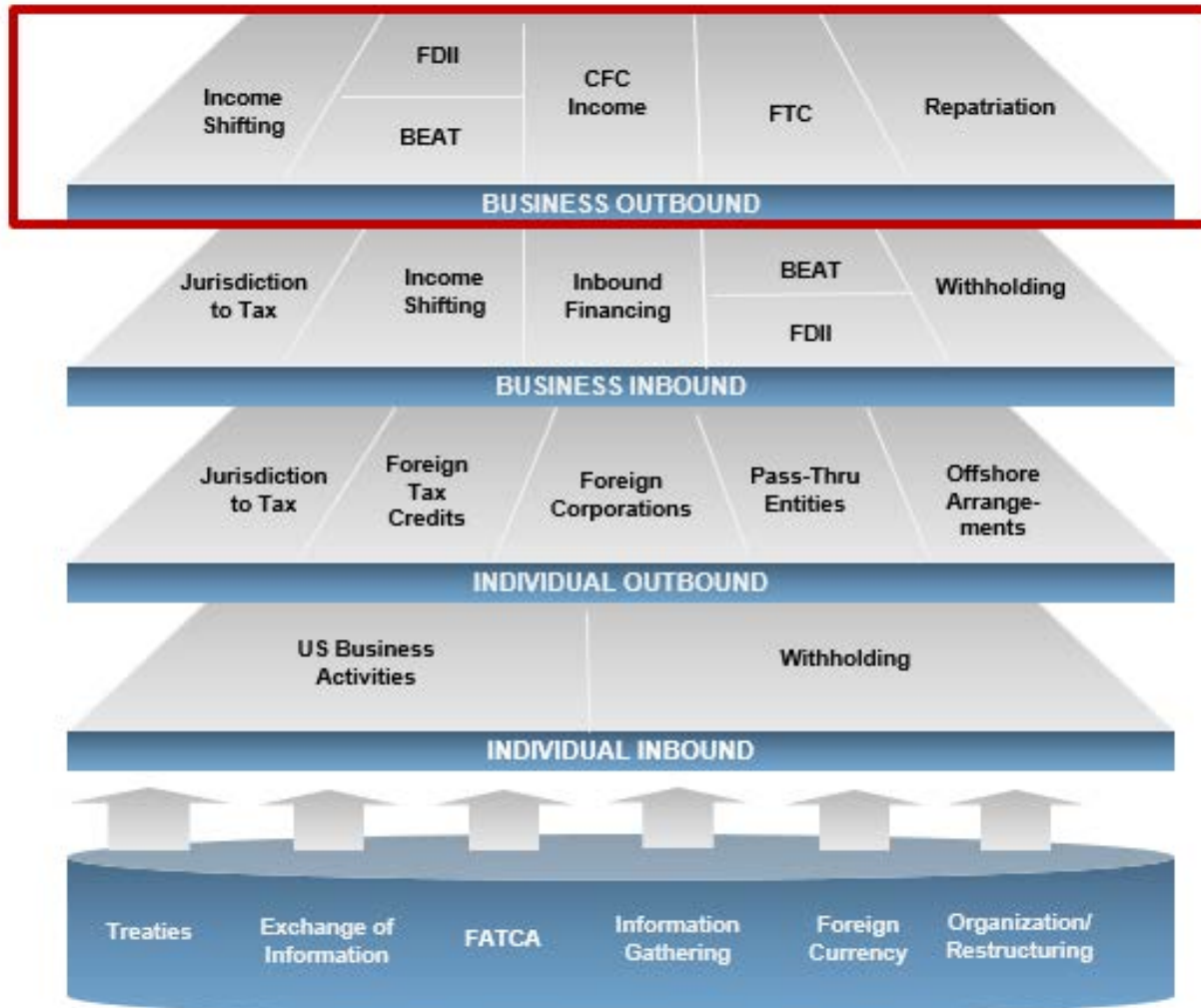

Business Outbound (Cont'd)

Income Shifting	FDII / BEAT	CFC Income	Foreign Tax Credit	Repatriation
STRATEGIC PRIORITIES				
IP Transfers	Foreign Derived Intangible Income	Global Intangible Low-Taxed Income	Creditability	Transition Tax (Section 965)
Cost Sharing Arrangements			Accessing FTCs	Previously Taxed Earnings and Profits
Services				
Risk Allocation				
Core Transfer Pricing	Base Erosion Anti-Abuse Tax	Subpart F	Source and Category of Income	Dividends Received Deductions
Gain Exportation / Loss Utilization	Expense Allocation and Apportionment			

Business Inbound

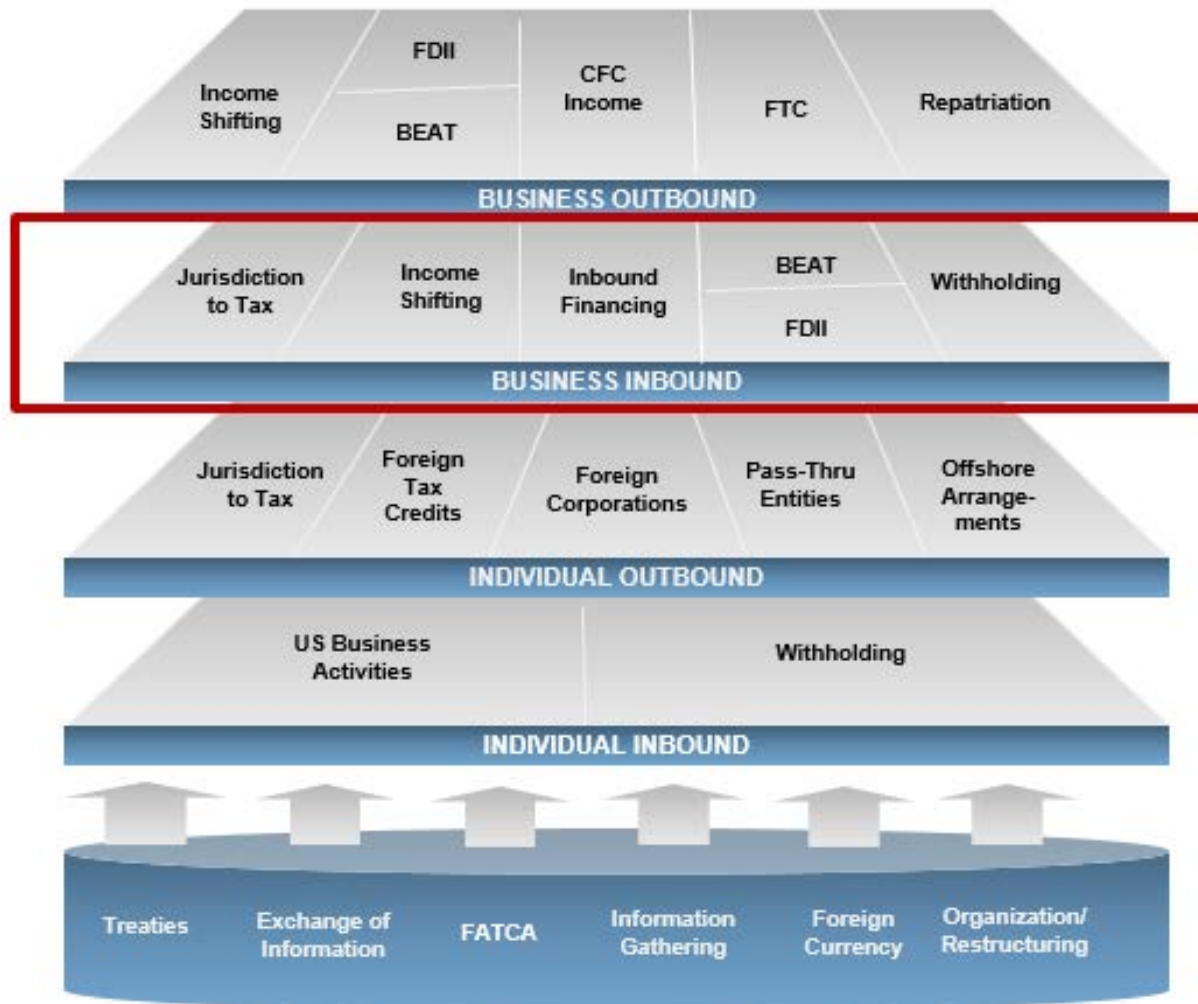

Business Inbound (Cont'd)

Jurisdiction to Tax	Income Shifting	Inbound Financing	BEAT / FDII	Withholding
STRATEGIC PRIORITIES				
Foreign Controlled Corporations	Transfer Pricing for Foreign Controlled Corporations	Loans through low-tax affiliates	Base Erosion and Anti-abuse Tax	Fixed, Determinable, Annual or Periodic (FDAP) Payments
US Branch / Permanent Establishment (PE)	Income Attributable to US Branch / Permanent Establishment (PE)	Hybrid Payments Cashless Debt		Foreign Investment Real Property Tax Act (FIRPTA)
Branch Taxes	Gain Exportation / Loss Utilization	Limitation on Interest Section 163(j) Foreign Parent Guarantees	Foreign Derived Intangible Income	Foreign Partners
Specialized Treatments		Other Strategies		

Individual Outbound

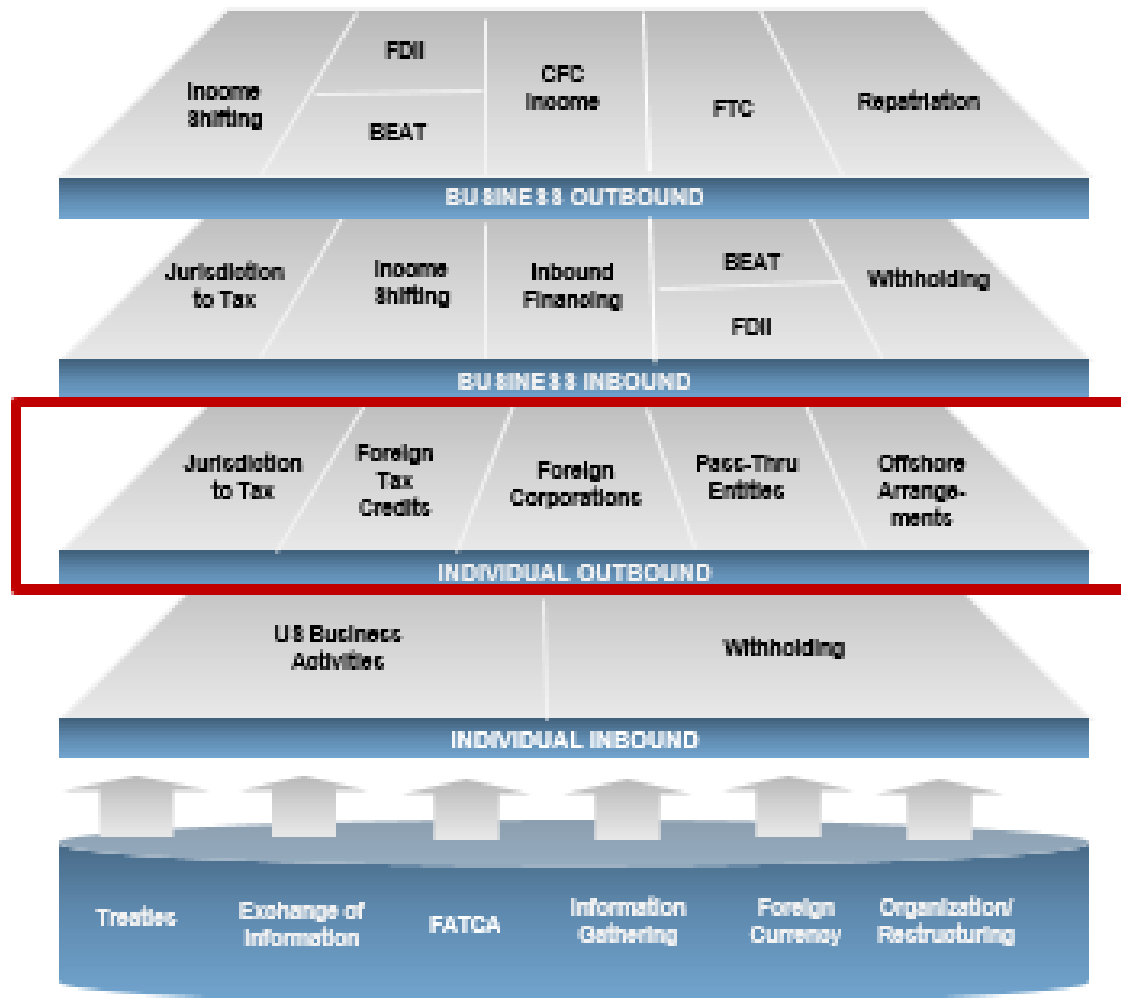

Individual Outbound (Cont'd)

Jurisdiction to Tax	Foreign Tax Credit	Foreign Corporations	Pass-Thru Entities	Offshore Arrangements
STRATEGIC PRIORITIES				
Citizens and Permanent Residents	Character and Source	Controlled Foreign Corporation (CFC)	Partnerships	Merchant Accounts
Exclusions	Creditability		Trusts	Insurance
Compensation	Treaty Limits	Passive Foreign Investment Company (PFIC)	Disregarded Entities	Private Banking
Possessions				Hedge Funds

Individual Inbound

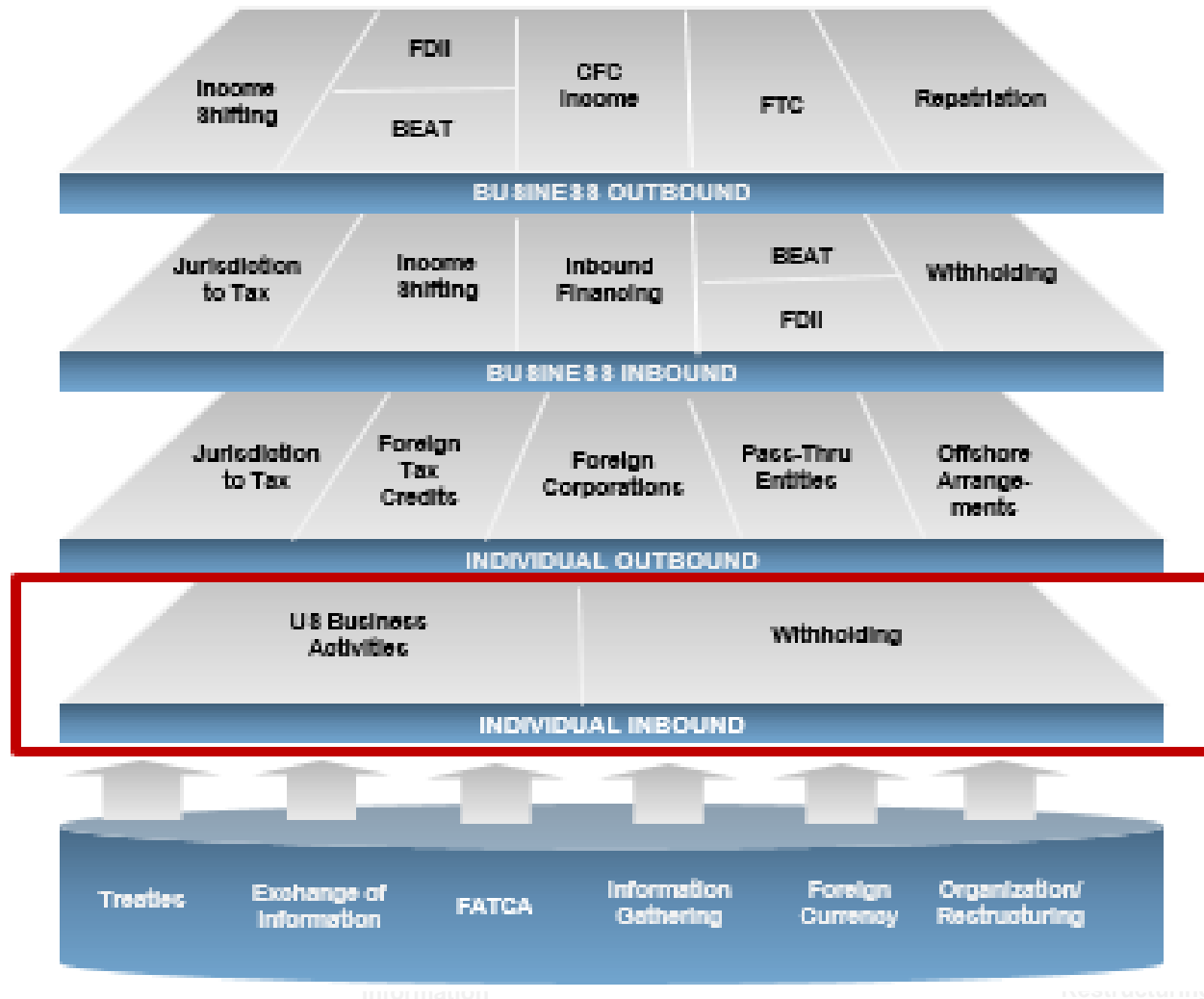

Individual Inbound (Cont'd)

US Business Activities	Withholding
STRATEGIC PRIORITIES	
Identification of US Trade or Business or Permanent Establishment (PE)	Fixed, Determinable, Annual or Periodic (FDAP) Payments
Effectively Connected Income (ECI)	Foreign Investment Real Property Tax Act (FIRPTA)
	Foreign Partners
Compensation from Employment	ECI through Trusts
Foreign Athletes and Entertainers	

Cross-Overs

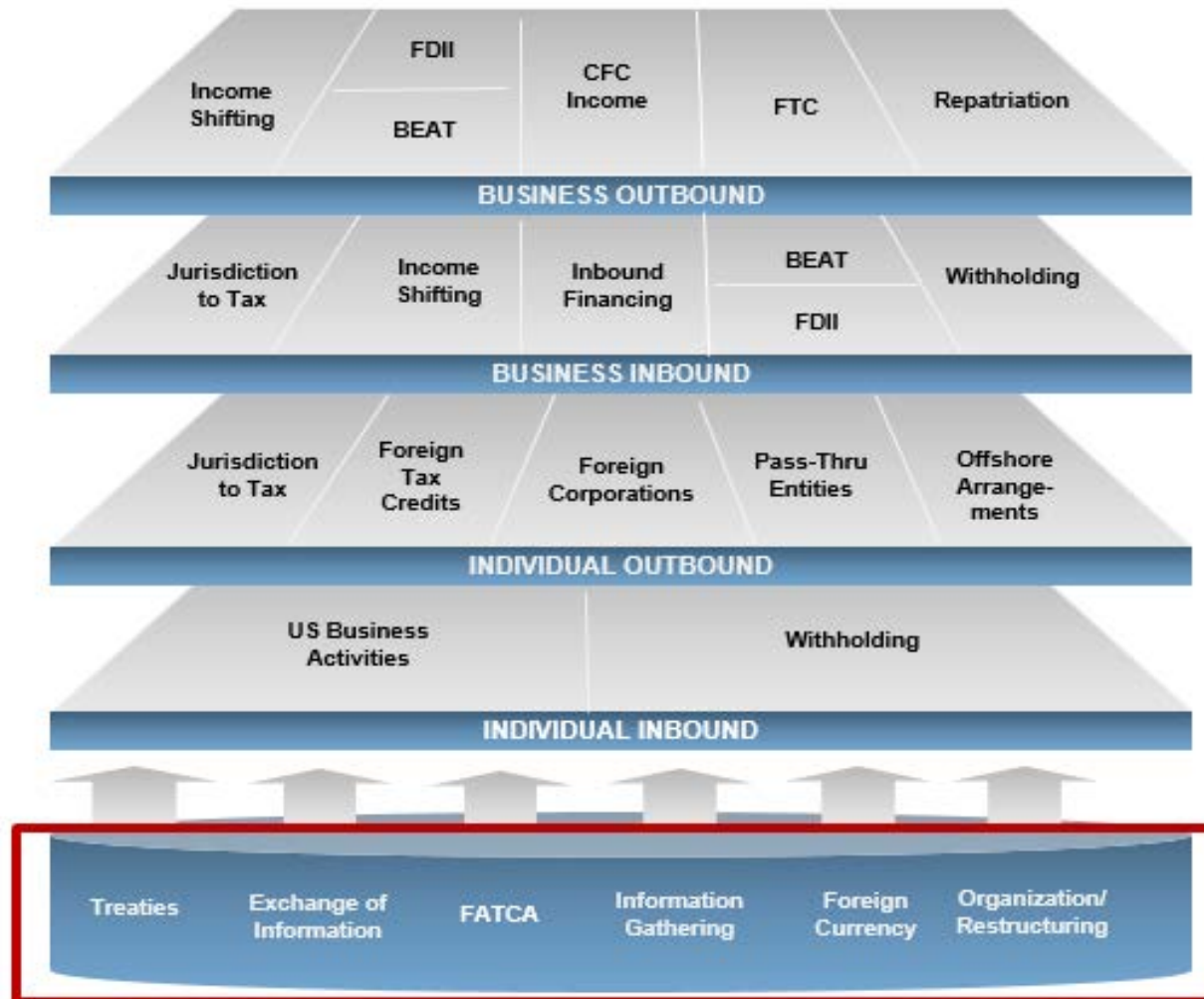



C. International Knowledge Base



**Large Business
& International**

International Knowledge Base

- The International Knowledge Base (IKB) is home to a wealth of tax resources to aid in the examination of outbound and inbound international issues involving businesses and individuals. From the International Knowledge Base, you may access:
 - Practice Units
 - Practice Networks
 - Practice Network Hot Topics
 - International Knowledge Base Consolidated Calendar of Events
 - Other International Resources

Multiple Ways to Navigate to the International Knowledge Base

The International Knowledge Base is mere clicks from IRS Source Home:

- 1) People & Offices → Business Units → LB&I → Examination Resources → LB&I Knowledge Management → select International Book
- 2) Popular Sites → Knowledge Management → IRS Virtual Library → Examinations → select International Book
- 3) LB&I Home → Popular Links → LB&I Knowledge Management → select International Knowledge Base from the list of LB&I Knowledge Bases → select International Book
- 4) Add the URL to favorites

International Knowledge Base Navigation

People & Offices – Business Units



The screenshot shows the IRS SOURCE website navigation menu. The header includes the IRS logo and the text "IRS SOURCE Working Together, Serving Taxpayers". A search bar is located in the top right corner. The main navigation menu consists of several tabs: "About IRS", "People & Offices", "News & Events", "Forms & Publications", "Job Resources", "Employee Resources", "Office Resources", and "Computers & Technology". Below the "People & Offices" tab, there is a sub-menu with "Commissioner's Corner" and "Business Units". The "Business Units" link is highlighted with a red box. To the right of the sub-menu, there is a "DAILY NEWS" link.

 Search this site							
Working Together, Serving Taxpayers							
About IRS	People & Offices	News & Events	Forms & Publications	Job Resources	Employee Resources	Office Resources	Computers & Technology
Commissioner's Corner		DAILY NEWS					
Business Units							

International Knowledge Base Navigation

Large Business and International (LB&I)

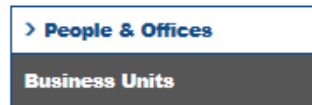

IRS Source Home > People & Offices > Business Units

Business Units

[IRS Organization and Top Officials - organization chart \(.pdf\)](#)

[IRS Organization and Top Officials text-only version \(Word\)](#)

Top Level IRS Organizations

- **Appeals** - assists taxpayers to settle tax disagreements without having to go to Court
- **Chief Of Staff (COS)** - executive secretariat office, provides support to the Office of the Commissioner
- **Chief Counsel** - provides legal guidance and interpretative advice to the IRS
- **Commissioner** - Commissioners' Corner intranet site containing messages from the IRS Commissioner
- **Communications & Liaison (C&L)** - supports the IRS mission by building relationships and understanding between IRS and its stakeholders through effective information sharing
- **Taxpayer Advocate Service (TAS)** - helps employees help taxpayers resolve problems with the IRS

Services and Enforcement Organizations

- **Deputy Commissioner Services and Enforcement** - messages from and information about the Deputy Commissioner and the Services and Enforcement segment of the IRS
- **Criminal Investigation (CI)** - law enforcement arm of the IRS
- **Large Business and International (LB&I)** - serves corporations, S subchapter corps, partnerships /w assets >\$10M- cross-functional cooperation in addressing emerging international issues
- **Office of Professional Responsibility (OPR)** - regulates enrolled agents, attorneys, CPAs and others who practice before the Service

International Knowledge Base Navigation

Examination Resources – LB&I Knowledge Management

The screenshot shows the IRS SOURCE website navigation menu. The 'Examination Resources' tab is selected, and a dropdown menu is visible. The 'LB&I Knowledge Management' option is highlighted with a red box. The dropdown menu includes the following items: Audit Tools, Case Administration, LB&I Campaigns, **LB&I Knowledge Management**, Research, and Specialists. The main content area shows a 'Large Business & International' section with an 'OVERVIEW' heading and a 'Popular Links' section with several links.

IRS SOURCE
Working Together, Serving Taxpayers

Search this site... [Advanced Search](#)

LB&I Home | [About LB&I](#) | [People & Offices](#) | [News & Events](#) | **Examination Resources** | [Employee Resources](#) | [Computers & Technology](#) | [Guidance & Procedures](#)

Large Business & International

OVERVIEW
The Large Business and International (LB&I) Division...
partnerships with assets greater than \$10 million...
employees, deal with complicated issues involving...
business in an expanding global environment.

Popular Links

- ▶ Getting It Right Together
- ▶ Intranet Content Crosswalk
- ▶ LB&I Opportunities
- ▶ LB&I Campaigns
- ▶ Tax Reform
- ▶ LB&I Tax Center (www.irs.gov)
- ▶ LB&I Knowledge Management

Tools & Services

- ▶ LB&I Focus Guide

[LB&I Featured Headline](#) | [Our Team Stories](#)

International Knowledge Base Navigation

Popular Links – LB&I Knowledge Management

The screenshot shows the IRS SOURCE website interface. At the top left is the IRS SOURCE logo with the tagline "Working Together, Serving Taxpayers". To the right is a search bar with the text "Search this site..." and a magnifying glass icon, and a link for "Advanced Search". Below the logo is a horizontal navigation menu with the following items: "LB&I Home", "About LB&I", "People & Offices", "News & Events", "Examination Resources", "Employee Resources", "Computers & Technology", and "Guidance & Procedures".

The main content area is divided into several sections. On the left is a "Large Business & International" section with an "OVERVIEW" sub-section. The text in the overview states: "The Large Business and International (LB&I) Division works with large corporations, partnerships with assets greater than \$10 million, and other entities that employ large numbers of employees, deal with complicated issues involving international tax, and conduct business in an expanding global environment." Below this is a "LB&I Featured Headline" section.

In the center is a "Our Team Stories" section. A dropdown menu is open over this section, listing the following items: "Audit Tools", "Case Administration", "LB&I Campaigns", "LB&I Knowledge Management" (highlighted with a blue bar), "Research", and "Specialists".

On the right is a "Popular Links" section with a list of links: "Getting It Right Together", "Intranet Content Crosswalk", "LB&I Opportunities", "LB&I Campaigns", "Tax Reform", "LB&I Tax Center (www.irs.gov)", and "LB&I Knowledge Management" (highlighted with a red box). Below this is a "Tools & Services" section with a link for "LB&I Focus Guide".

International Knowledge Base Navigation

LB&I Knowledge Management – Resources: IKB

Resources:

[Servicewide Knowledge Management](#) - to find out more information about knowledge management

[IRS Virtual Library](#) - to find knowledge bases active and under development

[Practice Units](#) - to find current list of published Practice Units on irs.gov

LB&I Knowledge Bases □

Knowledge Base

Shelf

▣ [Title : Corporate/Business Issues & Credits](#) (4)

▣ [Title : Financial Institutions & Products](#) (4)

▣ [Title : Industry Knowledge Base](#) (5)

▣ [Title : International Knowledge Base](#) (7)

[*International Knowledge Base Home](#)



International Knowledge Base Home

Welcome to International Knowledge Base

Home to a wealth of tax resources to aid in the examination of Inbound and Outbound International issues involving Businesses and Individuals. NEW! Details on the International Matrix (Post 2017 TCJA) are now available, see the FAQs on the right side of this knowledge base

Business Outbound				
Income Shifting (Outbound)	Deferral Planning	FTC Management	Repatriation	
Business Inbound				
Jurisdiction to Tax (Inbound)	Income Shifting (Inbound)	Inbound Financing	Repatriation / Withholding	
Individual Outbound				
Jurisdiction to Tax (Outbound)	Foreign Tax Credit	Foreign Corporations	Pass Thru Entities	Offshore Arrangements
Individual Inbound				
U.S. Business Activities	Withholding			
Cross-Over				
Treaties	Exchange of Information	Information Gathering	Foreign Currency	Organization/ Restructuring

What Did We Learn?

You should now be able to:

- A. Identify the international provisions changed by 2017 US tax reform, commonly referred to as TCJA
- B. Identify the elements of the updated International Matrix for TCJA, including strategic priorities
- C. Locate the International Knowledge Base



Appendix



**Large Business
& International**

Glossary of Terms

Acronym/Terms	Definition
BEAT	Base Erosion and Anti-Abuse Tax
CFC	Controlled Foreign Corporation
DRD	Dividends Received Deduction
DTIR	Deemed Tangible Income Return
E&P	Earnings and Profits
FDII	Foreign-Derived Intangible Income
FTC	Foreign Tax Credit
GILTI	Global Low-Taxed Intangible Income
PFIC	Passive Foreign Investment Company
QBAI	Qualified Business Asset Investment
REIT	Real Estate Investment Trust
RIC	Regulated Investment Company
SFC	Specified Foreign Corporation
TCJA	Tax Cuts and Jobs Act

