



LEAPERS[®], INC.

OPTICS

USER MANUAL

**Complete Installation and
Operating Instructions**

WWW.LEAPERS.COM

LEAPERS® INC.

Proudly Presents



OPTICS

TOTAL SOLUTIONS FOR ALL YOUR HUNTING AND SHOOTING NEEDS

Innovation, Quality, Value, and Service

www.leapers.com
32700 Capitol Street
Livonia, MI 48150 U.S.A.
Tel: (734)542-1500
Fax: (734)542-7095
Email: office@leapers.com

www.utgeurope.com
Am Bahndamm 7
63683 Ortenberg, Germany
Tel: +49 (0) 6041 – 969686 0
Fax: +49 (0) 6041 – 969686 66
Email: info@utgeurope.com

Index

A. Scope Parts Illustration	4
B. Major Features	7
C. Mounting the Scope Ring	8
D. Installing the Scope	9
E. Understanding the Reticle	10
F. Adjusting Eyepiece Diopter	14
G. Installing Battery	14
H. Adjusting Reticle Illumination	14
I. Adjusting Magnification	15
J. Adjusting Parallax	16
K. Zeroing	16
L. Removing and Installing Lens Caps	23
M. Installing Sunshade	23
N. Care and Maintenance	23
O. Limited Lifetime Manufacturer's Warranty	23

A. SCOPE PARTS ILLUSTRATION



WARNING:

Read entire manual before mounting your scope. Make sure the firearm is not loaded upon installation.

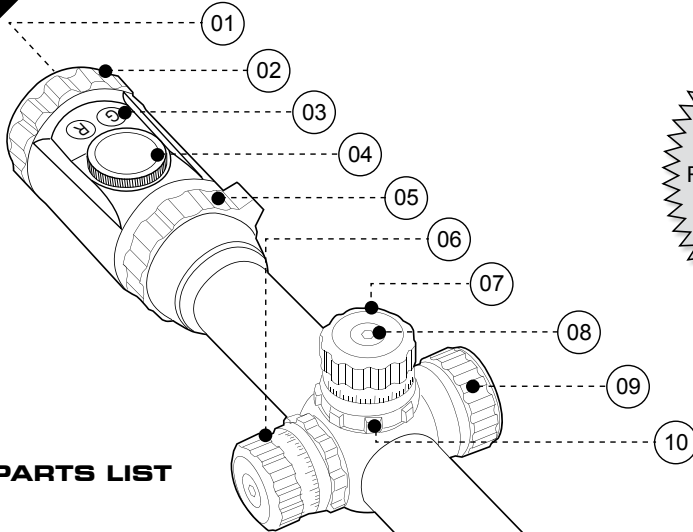

PARTS LIST

- 01 Ocular Lens
- 02 Eyepiece Assembly
- 03 EZ-TAP Control Panel (For Reticle Illuminated Models with IE Capability, Position may Vary)
- 04 Battery Chamber (for EZ-TAP Scope Only, Position may Vary)
- 05 Power Ring (For Variable Power Models Only)
- 06 Windage Adjustment Knob
- 07 Elevation Adjustment Knob
- 08 Zero Resetting Hex Screw (For Models with Center Hex Screw in Turrets)
- 09 Reticle Illumination Rheostat (For Reticle Intensified Models Only)
OR
Parallax Adjustment Side Wheel (For Side AO Models Only)
- 10 Zero Locking Ring (For Models with Zero Locking Function)
- 11 Objective Parallax Adjustment Ring (For Front AO Models Only)
- 12 Objective Lens Protective Ring (For Models with Protective Ring)
- 13 Objective Lens
- 14 Integral Sunshine Shade (For Models with Angled Objective Bell)

11

12

13

14

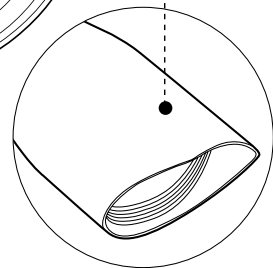

Note:

Scope diagram is for illustration purposes only, not intended to represent your actual product appearance.

ACCESSORIES

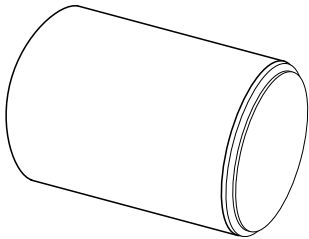

Optional - 3" Sunshade
(for 50mm Obj. Dia. Models)

Optional - 2.5" Sunshade
(for 40mm Obj. Dia. Models)

Optional - 2" Sunshade
(for 32mm Obj. Dia. Models)

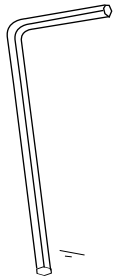

Allen Wrench
(One or multiple are
included. Size may vary.)

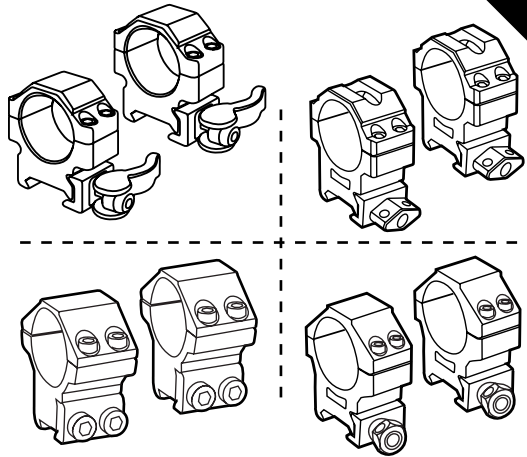

Mounting Rings
(Not all models include rings. Appearance may vary.)



Battery
(For Reticle Intensified
Models Only)



Cleaning Cloth

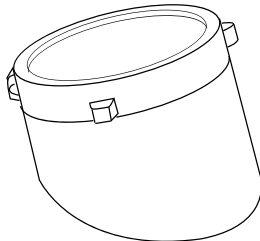
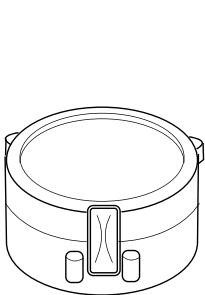

Flip-open Lens Caps
(Appearance may vary.)

B. MAJOR FEATURES

- ▶ **Built on the Signature True Strength™ Platform, Completely Sealed and Nitrogen Filled, Shockproof, Fogproof and Rainproof**
 - Rugged One-piece Integral Aluminum Main Tube
 - Internal Smart Spherical Structure (SSS) simplifies and strengthens the interaction between the inner/outer tube for a more responsive, precise, and reliable windage/elevation adjustment
 - Disciplined quality control and extensive shock testing guarantees optimal recoil resistance and reliable zero hold
- ▶ **Broadband Multi-Coated Lenses**
 - Individual multi-coated lenses provide a bright and crisp image with a light transmission rate over 95%
 - Ensures maximum utilization of all available ambient light providing higher resolution and clarity
- ▶ **High Quality Precision Machined Parts**
 - Guarantees smooth reliable operation and delivers consistent and accurate performance
- ▶ **Red/Green Dual Color and or 36-color I^E® (Illumination Enhancing) Reticle Illumination Options**
 - Adjustable reticle color and intensity provides optimum clarity and contrast in different various light conditions and environments

C. MOUNTING THE SCOPE RING

CAUTION: Make sure firearm is not loaded. Remove magazine (if applicable) and examine chamber. Use safe handling procedures at all times.



C-1. QD Lever Lock Scope Rings



C-2. Twist Lock Scope Rings



C-3. Thumb Nut Locking Scope Rings



C-4. Hex Screw Locking Scope Rings

★ C-1. Mounting QD Lever Lock Scope Rings



1. Turn the Cam Lever in the direction that widens the spring loaded locking plate and provides the needed mounting clearance for installation. Make sure the QD mount base's cross bolt seats properly within the Picatinny slot.



2. Turn the Cam Lever in the opposite direction to close the spring loaded locking plate, locking the QD mount base to the Picatinny rail.



3. Should the QD mount base be loose, unlock the Cam Lever and use the included Allen Wrench to adjust the Hex Screw found within the Cam Lever Housing. Turning the Hex Screw clockwise will increase the locking plate tension by decreasing the clamping width.



4. Should the Cam Lever not fully turn into the locked position and you feel heavy resistance, the locking plate tension is too high. Use the included Allen wrench to adjust the Hex Screw counterclockwise to decrease the locking plate tension by increasing the clamping width.



5. The optimal tension is achieved when the locking plate first makes contact with the Picatinny rail while the Cam Lever still has enough travel left for you to turn the Cam Lever to the locked position.

★ C-2, C-3. Mounting Twist Lock and Thumb Nut Locking Scope Rings

Locking Holes

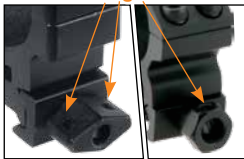

1. Turn the Twist Lock or Thumb Nut counterclockwise to widen the locking plate and provide the needed mounting clearance to evenly seat onto the Picatinny Rail.
2. Once seated, turn the Twist Lock or Thumb Nut clockwise to tighten the locking plate and secure the scope ring to the Picatinny rail. Do not exceed 30 inch-pounds.

★ C-4. Mounting Hex Screw locking Scope Rings



Stop Pin



1. Turn the Hex Screws counterclockwise with the included Allen wrench to widen the locking plate and provide the needed mounting clearance to evenly seat onto the Dovetail Rail.
2. If applicable, seat the rings in a position along the rail where the ring's Stop Pin can fully seat and make contact with one of the Dovetail rail's recessed stop pin holes.
3. Once seated, turn the Hex Screws clockwise using the included tool to tighten locking plate and secure the scope ring to the Dovetail rail. Do not exceed 30 inch-pounds.

D. INSTALLING THE SCOPE

(ring style in the following images is for illustration purposes only. Your specific style may vary)



1. Using the included Allen wrench, turn the screws counterclockwise to completely remove the top half of the rings.



2. Place the scope within the scope ring bases, taking care to properly adjust for a comfortable eye relief and that the scope's reticle is leveled.



- Carefully reinstall the top half of the rings evenly and securely in a cross-torque pattern. Do not exceed over 15 inch-pounds of torque as damages to the scope tube may occur. It is recommended to grasp the Allen Wrench by its short end to perform final tightening. The scope is now ready to be zeroed.

E. UNDERSTANDING THE RETICLE

Leapers offers a variety of reticles for different scopes. See the following reticle information for details pertaining to your specific scope reticle.

- For Leapers scopes, the reticle is on the second image plane. The reticle does not change when the magnification is adjusted. But, the space the reticle occupies on the target image does change when magnification changes. The smaller the magnification, the bigger space the reticle occupies on the target image.

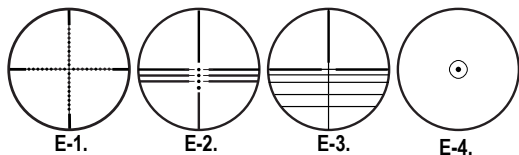

E-1.

E-2.

E-3.

E-4.

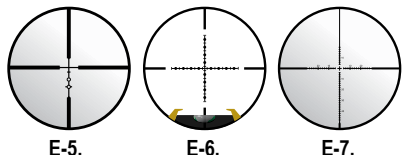

E-5.

E-6.

E-7.

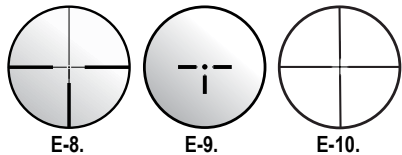

E-8.

E-9.

E-10.

E-1. MIL-DOT RETICLE: The Mil-dot reticle including wire and etched reticles, is the most widely used reticle on Leapers scopes which provides range estimating capability. The reticle has a big crosshair with multiple dots (or hash marks in order to save space) spread equally apart on its lines in the central area. The distance between two adjacent dots is designed to be 1 milli-radian or 3.44MOA at 10X.

Regular Mil-dot reticles currently on the market usually have 4 dots in each direction. Leapers scopes have 6 or 9 dots in each direction, depending on the scope model, providing more flexibility for range estimating. For

the Mil-dot reticle with 9 dots in each direction, including the counting of the 2 inner tips of the opposite crosshairs, that amounts to 21 available aiming points.

E-2. PRO 4-STEP RETICLE: Designed for the discriminating crossbow shooters, the new etched glass Pro 4-step reticle comes with 3 horizontal lines and 4 floating points. Only the floating points are illuminated. The 3 horizontal lines with floating points in the middle are for shooting at 20, 30 and 40 yard distances. The Free Floating (4th) point is for shooting at 50 yards.

E-3. PRO 5-STEP RETICLE: The Pro 5-step reticle is designed for crossbows. The reticle consists of five horizontal lines and a vertical line. There is a thin crosshair in the center. The horizontal lines are for aiming at 10, 20, 30, 40 and 50 yard distances. The lines are calibrated for 300fps crossbows. The user needs to find out the exact yardage of each line during the zeroing process.

E-4. CIRCLE DOT RETICLE: The Circle Dot reticle includes a floating circle and a dot in the center, which is ideal for shotgun shooting, and fly hunting as well as tactical applications requiring quick target acquisition. It may be permanently etched on glass or formed by light reflection. For an etched Circle Dot, the typical size is about 1.8MOA for the dot and about 36MOA for the circle. The reflex Circle Dot is a reflected image of the light source and the typical size can be controlled to about 4MOA for the dot and about 62MOA for the circle.

E-5. PDC RETICLE: The PDC (Projectile Drop Compensation) reticle of our handgun scope has 3 uniquely shaped marks positioned in the lower region of the crosshair's Y Axis just below the origin for ballistic compensation at different yardages. Users can determine the actual POI (Point of Impact) at each mark for their particular firearm and cartridge following the zeroing procedure on page 12.

E-6. BUBBLE LEVELER EQUIPPED RETICLE: Bubble leveler equipped reticles include a precision built-in bubble leveling system. The internal bubble leveler is located at the bottom of crosshair with the least field of view impediment. It is a great tool for precision scope installation/crosshair alignment to deliver the most prominent shooting accuracy.

E-7. ETCHED UMOA: The MOA (UMOA) reticle features hash marks at MOA increments for precise bullet drop and wind drift compensation as well as range estimation. At 10X magnification and 100 Yards, the reticle provides a 4MOA (from end to end) center cross and equally distanced hash marks at 2MOA all the way to 50MOA for hold over, 20MOA for hold under, and 30MOA on each side for wind drift compensation. The center cross can be illuminated to assist aiming under different light conditions.

E-8. ETCHED G4: The G4 reticle integrates the classic German #4 design with our innovative 36-color Illumination Enhanced (IE[®]) system. Thick bars at 3, 6, and 9 o'clock positions help the eye quickly locate the center of the reticle, yet, leave a space of 10 milliradians at 10X and 100 Yards from left to right allowing a less obstructed view. The fine horizontal and vertical lines along with a 0.5MOA center dot at 10X and 100 Yards provide the ability for precise aiming whenever needed.

E-9. PRECISION T-DOT: The T-Dot reticle is ideally used for fast center mass and T-zone aiming applications where getting shots on target quickly is a priority. The reticle consists of a single floating dot in the center as the aiming point with three floating posts arranged at the dot's 3, 6, and 9 o'clock positions. The posts are very quickly picked up by the eye, framing your target, while the single dot provides precision aiming of the area of interest on the target.

E-10. DUPLEX RETICLE: Duplex reticle consists of thin crosshairs in the center and four posts extending to the reticle perimeter from the edges of the thin crosshairs. The thicker posts stand out against the

background, while the thin crosshairs are for precise aiming and better view of the area of interest on the target. Duplex reticle could be etched on glass or etched from metal thin film. Accordingly, the center crosshair may be floating or connected to the outer bars.

★ Zeroing the Pro 4-Step Reticle:

Follow the steps below to zero a scope with Pro 4-step Reticle on a crossbow:

1. First of all, adjust the speed dial ring on the scope to match the speed of your crossbow (275 to 385 feet per second).
2. Place a target 20 yards away, sight the crossbow in using the top horizontal line/point. (Please refer to the Zeroing section for W/E adjustment).
3. Once sighted in at 20 yards, the top horizontal line/point will be zeroed in at 20 yards. The next line/point should be accurate at approximately 30 yards, the 3rd line/point at approximately 40 yards, and the 4th floating point at approximately 50 yards.

Fine-tune your scope settings at the 30, 40 or 50-yard line/point using the scope's speed dial. If you are hitting high at the 30, 40 or 50-yard distances, adjust the speed dial ring towards a higher speed level. Or, if hitting low, adjust the dial ring towards a lower speed level. Adjust until hitting the bulls-eye.

★ Zeroing the Pro 5-Step Reticle:

Follow the steps below to zero a scope with Pro 5-step Reticle on a crossbow:

1. Place a target 10 yards away, aim at the center of the target with the center crosshair and sight in. (Please refer to the Zeroing section for W/E adjustment)
2. Once sighted in at 10 yards, the center crosshair/line will be zeroed in at 10 yards, depending on your crossbow and arrow. The 2nd descending crosshair/line should be accurate at approximately 20 yards, the 3rd descending crosshair/line at approximately 30 yards, the 4th crosshair/line at approximately 40 yards, and the 5th crosshair/line at approximately 50 yards.
3. Walk back 8-10 yards from the sight-in position and fire shots at the center of the target with the 2nd descending crosshair/line until hitting the bulls-eye. Fine-tune the shooting distance back and forth to determine the accurate yardage of the 2nd descending crosshair/line.
4. Perform the same steps for each of the remaining crosshair lines.

★ Zeroing the PDC Reticle:

1. Place your target at the distance of your choosing. We recommend 35 yards. Next, set your scope to the highest magnification. At this point we recommend using a bore sighter for initial zeroing. Aim at the center of the target using the crosshair's origin and refer to the zeroing section of the manual next for making windage and elevation adjustments.
2. Shoot at each 50 or 100 yard increment depending on the trajectory of your firearm and cartridge, using one mark in the lower vertical crosshair each time. Record the bullet point of impact in relation to your point of aiming.
3. Make adjustment to the shooting distance accordingly to determine the actual yardage each mark represents. We highly recommend that you document these distances.
4. Use hold-over or under in real applications for in-between yardages.



★ Please refer to section K for zeroing other types of reticles.

★ Eyepiece Locking Ring

The handgun scope is equipped with an eyepiece locking ring to prevent the eyepiece's diopter focus from deviating. To adjust the eyepiece diopter, first turn the eyepiece counterclockwise to unlock it. Then, turn the locking ring clockwise away from the eyepiece to allow room for adjustment. Follow the instructions in the Adjusting Diopter section of the manual for adjustment procedures. Once complete, turn the locking ring counterclockwise to tighten it against the eyepiece.

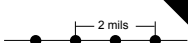

★ Mil-Dot Reticle Range Estimating:

1. 1 mil in a scope reticle is the distance from the center of one dot to the center of the next dot. 
2. Range estimating requires common knowledge/experience about your target's actual width or height. 
3. Set your scope at 10X or the biggest power if its highest magnification is less than 10X. View the target through the scope. Place the center of the dot against one edge of the target and measure to the opposite edge of the target.
4. Once the target has been measured in mils, a formula is available to estimate the distance of the target.
5. Each mil-dot scope comes with a mil-dot card showing the particular formula applicable to that scope and a pre-calculated mil-dot table of most used distance estimates to aid the user.

Mil-dot Range Estimating Example:

(The formula is for illustration purposes only. For your mil-dot scope, use the formula on your mil-dot card.)

For example, based on past experiences, the length of a known animal from shoulder to tail is 40 inches (1.016 meters), and we see through a scope at, for example, 9X to find that the animal occupies 9 mils. Therefore, the distance can be derived from using the following formula -

$$\frac{\text{Height or Width of Target in Meters} \times 1,000}{\text{Height or Width of Target in Mils}} \times \frac{\text{Magnification}}{10} = \text{Range in Meters (1 M} = 1.0936 \text{ Yards)}$$

Hence, $(1.016 \times 1,000/9) \times (9/10) = 101.6$ meters (110Yds).

Armed with this knowledge, you can compensate for the bullet's drop accordingly and make "great things happen"!

★ UMOA Reticle Range Estimating:

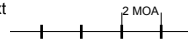
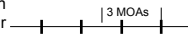
1. 1 MOA in a scope reticle is half of the distance from the center of one hash mark to the center of the next hash mark. 
2. Range estimating requires common knowledge/experience about your target's actual width or height. 
3. Set your scope at 10X or the biggest power if its highest magnification is less than 10X. View the target through the scope. Place the center of the hash mark against one edge of the target and measure to the opposite edge of the target.
4. Once the target has been measured in MOAs, a formula is available to estimate the distance of the target.

UMOA Range Estimating Example:

For example, based on past experiences, the length of a known animal from shoulder to tail is 40 inches (1.016 meters), and we see through a scope at, for example, 9X to find that the animal occupies 20 MOAs. Therefore, the distance can be derived from using the following formula -

$$\frac{\text{Height or Width of Target in Meters} \times 3,438}{\text{Height or Width of Target in MOAs}} \times \frac{\text{Magnification}}{10} = \text{Range in Meters (1 Meter} = 1.0936 \text{ Yards)}$$

Hence, $(1.016 \times 3,438/20) \times (9/10) = 157.2$ meters (172Yards).

Armed with this knowledge, you can compensate for the bullet's drop accordingly and make "great things happen"!

F. ADJUSTING EYEPIECE DIOPTER

(Eye Piece Adjustment)

Diopter adjustment provides additional focus adjustment to adapt the scope to your eyesight.



1. Diopter adjustment ring is located at the ocular end of the scope. Point the scope at an uncluttered and light colored background object, such as a white wall. Look through the scope and turn the dial ring clockwise or counter-clockwise until the reticle looks the sharpest to you at first glance.

2. Note: Different individuals will have a different eye focus which will result in a different diopter setting. A person will use different diopter settings with or without eye glasses.

G. INSTALLING BATTERY

(For Reticle Intensified Models Only)



G-1. EZ-TAP

G-2. Side Rheostat

1. The battery is housed inside the Red/Green Illumination Rheostat.
2. With one hand, firmly hold the Rheostat's housing in place while simultaneously unscrewing the battery cap with your other hand.
3. Place the battery within the Illumination Rheostat housing with the + side facing upward.
4. Screw the battery cap back on until tight using the same method in Step 2.

H. ADJUSTING RETICLE ILLUMINATION

(For Reticle Intensified Models Only)



H-1.

Color Coded/Numbered Rheostat

H-2.

Color Coded/Fine Adjustment Rheostat

H-3.

EZ-TAP® Console

★ H-1 and H-2 Illumination Adjustment

Dial the Rheostat to turn on the illumination and verify its color and brightness at each position.

★ H-3 Illumination Adjustment (IE® Models)

Memory Feature

When turned on, H-3 illuminated reticle shows the same color and brightness you last used.

Turn On/Off

1. Press either the **G** or **R** button to turn on the light.
2. Press and hold either the **G** or **R** button for 1 second to turn off the light.
3. Light will go off after 1 hour with no action.



Operating in the RGB Mode

1. Press the **R** button to turn the red light on or to change brightness of the red light.
2. Press the **G** button to turn the green light on or to change brightness of the green light.



Switching between RGB and Multi-Color Modes

1. The default mode is the **RGB** mode.
2. To switch between the **RGB** mode and the **Multi-Color** mode, press and hold BOTH **G & R** buttons at the same time for 1 second.



Operating in Multi-Color Mode

1. Press the **R** button to change the color between the selections in the Color Index Table.
2. Press the **G** button to change the color intensity as shown in the Color Index Table.

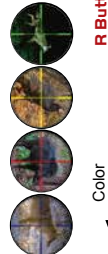

Color Index Table					
G Button		Intensity →			
Magenta	Thistle	Plum	Violet	Orchid	Purple
Pink	Rosy Brown	Coral	Crimson	Brown	Maroon
Yellow	Khaki	Orange	Golden Rod	Chocolate	Olive
Law Green	Plain Green	Spring Green	Olive Drab	Sea Green	Forest Green
Cyan	Azure	Turquoise	Cadet Blue	Dark Cyan	Teal
Blue	Sky Blue	Dodger Blue	Indigo	Midnight Blue	Navy

I. ADJUSTING MAGNIFICATION

(For Variable Power Models Only)

1. For variable power scopes, there is a power ring in front of the eyepiece assembly. To change magnification, turn the ring to align the desired number on the ring with the index dot on the main tube.
2. The lower power provides wider field of view for quick aiming at close range. The higher power is for precise long-range aiming. When the numbers on the ring are not visible under low light condition, turn the ring left to increase the power, turn the ring right to decrease the power.

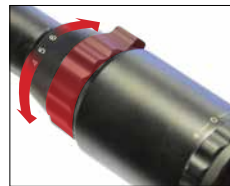

I-1. Adjusting Power Ring

3. **Note:** Never loosen the screw in the power ring. Doing so will break the sealed state of the scope and destroy the fogproof feature. The power ring should not be disassembled. Do not try to lubricate it. Any such action will void the warranty.



I-2. Power Ring Screw

J. ADJUSTING PARALLAX

(For Models with Adjustable Objective Only)



J-1. Front AO Adjustment

J-2. Side Wheel Adjustable Turret (SWAT AO)

J-3. SWAT AO Big Wheel (Optional)

1. Find the proper type of dial from the images above.
2. Aim the scope at your target.
3. Dial the Parallax Adjustment Ring, Side Wheel or Big Wheel, depending on what is available on your model, to the desired distance setting until the target is in the sharpest focus and the center of the crosshair stays on the target while you examine the image by slightly moving your head.

K. ZEROING

The purpose of zeroing the scope is to ensure that the scope's reticle is aligned with the point of impact of the rifle and cartridge. Before zeroing the scope, read the following adjustment instructions carefully.

Note: For crossbow scopes with PRO 5 or 4-STEP Reticle & handgun scopes with PDC reticle, please also refer to Section E for more reticle-specific zeroing details.

Note: Each click of adjustment for the windage or elevation knob moves the POI (Point of Impact) by the amount shown in the table below:

	Inches of Movement per Click @ 100 Yards in Windage/Elevation		
	1/2" Per Click	1/4" Per Click	1/8" Per Click
25 yds	1/8"	1/16"	1/32"
35 yds	7/40"	7/80"	7/160"
50 yds	1/4"	1/8"	1/16"
100 yds	1/2"	1/4"	1/8"
200 yds	1"	1/2"	1/4"

Note: Since climatic conditions such as altitude, temperature, wind and rain can affect trajectory, you may experience some deviation in the exact settings during different shooting sessions.



K-1. Premium Zero Lockable/Resettable Target Turret

K-2. High Tower Zero Lockable/Resettable Turret

K-3. TF2+ Tool-free W/E

K-4. Click Adjustable Turret



K-5. True Hunter W/E (Turret Color May Vary)

K-6. Finger Adjustable W/E

K-7. Double Lock Turret (Turret Color May Vary)

★ K-1. Sniper W/E Operation

For Models with Premium Zero Lockable/Resettable Target Turrets:

1. Both the windage and elevation turrets are set to the locked position out-of-the-box.
2. To unlock the windage and elevation turrets rotate the zero locking rings at the base of the turrets counterclockwise 40-70 degrees until they stop.



Zeroing- Make sure the turrets are unlocked before performing this step if applicable.

Zeroing on a target

1. Using a bore sighter is recommended for initial zeroing
2. Place target at preferred zero distance.
3. Using a steadying device such as a bipod, shooting stand, bench rest, etc. turn on the scope, and if safe to do so, fire a test group at the center of the target.
4. If the POI(Point of Impact) of the test group is exactly in the center of the target then the POI is POA (Point of Aiming) and the scope is zeroed.
5. If the POI is not POA, further adjustments need to be made. Follow the POI directions found on each turret and make the necessary adjustments accordingly to achieve POI is POA and the scope is zeroed.

OPTIONAL: Zero Resetting (For Models with Zero Resettable Turrets)

Important Note: When turning the Zero Resetting Screw loose to disengage W/E. The Zero Locking Ring must be in the locked position. When tightening the Zero Resetting Screw to engage W/E, zero cannot be locked. Scope damage may occur if the steps are not followed.

1. If applicable, once the scope is zeroed and the Zero Locking Rings for both turrets are in the locked position, use the Allen wrench to turn the Zero Resetting Hex Screw 180-360 degrees counterclockwise. This will disengage the turrets.
2. Once the turrets are disengaged, rotating the turret will not produce any adjustment and will have no impact on your zero. Focusing on one turret at a time, reset the "0" markings found on the turrets by slightly pulling up on the turrets until they can freely rotate. Reposition the "0" markings back to the center position indicated by the white dot found on the side of each turret.
3. Once repositioned, unlock the Zero Locking Rings for both turrets and press the turrets down and back into their seated position.
4. Use the Allen Wrench to turn back the Zero Resetting Hex Screw 180-360 degrees clockwise until snug.

OPTIONAL: Zero Locking

1. (For models with Double/Single Lock Turrets)
2. If applicable, once the scope is zeroed, use the small Allen Wrench to lock the turrets back down by turning clockwise ¼ revolution until snug and the turrets can no longer make adjustments. Do not over torque the locking screws as this may damage the turrets. Screw the turret caps back on.
3. (For Models with Zero Lockable Turrets)
4. If applicable, once the scope is zeroed, rotate the Zero Locking Rings found on both turrets clockwise 40-70 degrees until finger tight.



★ **K-2.**
High Tower Zero
Lockable/Resettable
Turret

Bubble Leveler Scope Turret Operation:

1. The windage and elevation High Tower Lockable/Resettable turrets use a coin or screw driver to unlock the zero resetting screw at the top of the turret for zero resetting.



2. There are horizontal and vertical hash marks beneath the elevation and windage turret that are easy to see and indicate how many rotations you have dialed in after making adjustments beyond your zero. The bottom edge of the turret will reveal a hash mark each time you have made $\frac{1}{2}$ a rotation when moving up in elevation or to the right in windage and vice versa.



3. The purpose of the internal bubble leveler is to ensure a consistent orientation of the scope during each shot. When optimum accuracy and confidence is a must, you do not want the scope tilted to the left or right of center when taking that critical shot. The scope must have been installed correctly positioned and leveled with the specific application being used in the beginning.

ZEROING

Mount the scope on the application. Make sure the mounting system is tight and set properly, the scope cannot be tilted in any direction whatsoever on the application. **Unlock the windage and elevation turrets to allow for adjustments.** Unlock the windage and elevation turrets by rotating the Zero Locking Rings at the base of the turrets counterclockwise 40-70 degrees until they stop.

Zeroing on a target

1. Using a bore sighter is recommended for initial zeroing.
2. Place target at preferred zero distance
3. Use the built-in bubble leveler to ensure a consistent orientation of the scope with each shot. Sighting through the scope as though you were going to shoot, make adjustments to the turrets until the crosshair matches with the point of aim (POA) of the bore sighter.

4. Remove your bore sighter and confirm your zero with a live fire test group if safe to do so.
5. If the point of impact (POI) of the test group is exactly in the center of the target then the POI is POA and the scope is zeroed.
6. If the POI is not POA, further adjustments need to be made. Follow the POI directions found on each turret and make the necessary adjustments accordingly to achieve POI is POA and the scope is zeroed.

ZERO RESETTING

Once the scope is zeroed, **tighten the locking rings to make sure they are fully locked before proceeding to resetting the zero marker on the windage and elevation turrets.**

After zeroing in, the "0" marker may not be facing you at the original center position. You can use the following steps to reset the "0" marker by rotating the "0" marker to the center position:

1. Use a one coin or screw driver to turn the Zero Resetting Screws on the top of the turrets counterclockwise 180-360 degrees to disengage the W/E turrets. Be sure not to overturn the Zero Resetting Screws. When a turret is "disengaged", the top portion of the turret will freely spin without making any physical adjustments to your zero.
2. Reposition the "0" marker to the center position.
3. Use a coin or screw driver to gently tighten down the Zero Resetting Screws to complete Zero Resetting.

ZERO LOCKING

1. Both the windage and elevation turrets are set to the locked position out-of-the-box. They must be unlocked first before making any adjustments.
2. To unlock the windage and elevation turrets rotate the Zero Locking Rings at the base of the turrets counterclockwise 40-70 degrees until they stop.
3. After satisfied with your zero, simply rotate the Zero Locking Rings at the base of the turrets clockwise 40-70 degrees until they stop to lock your turrets. Do not over-tighten. When the Zero Locking Rings are tightened, the windage and elevation turrets will not be able to turn, preventing any accidental movement resulting in loss of zero.

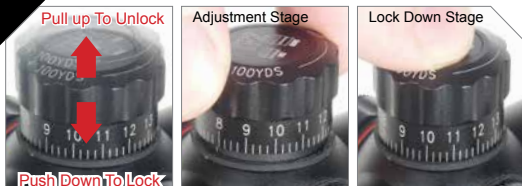

1. The Windage and Elevation Adjustment Knobs have a unique 2-stage Tool-free design. The windage/elevation knobs are in the "locked" mode on a new scope out of the factory. Pulling the knobs upward allows for windage/elevation adjustment.
2. **ZERO LOCKING** (The windage/elevation knobs are in the LOCKED position for a new scope out of the factory.)

When the adjustment knob is pushed down, the knob is "locked" and cannot be rotated. This will prevent any accidental movement to lose zero.

Note: To lock an adjustment knob requires proper gear engagement internally. Before pressing the knob down to lock, use minor force to push to get the feel of resistance. If tough to push down, make very slight rotational adjustment (no clicking) to locate the right position to press down. DO NOT force the lock-down.

ZEROING

Pull up the windage and elevation adjustment knobs to allow for adjustment.

1. Zeroing with a Bore Sighter
 - a. Follow the instructions that came with your bore sighter and install it in the muzzle of your rifle lining it up with the scope as close as possible.
 - b. Pull the windage/elevation knob out for adjustment.
 - c. Sighting through the scope as though you were going to shoot and dial the knobs to make adjustment for the windage or elevation until the crosshair matches the bore sighter.
 - d. Push the windage or elevation knob down to lock the zero position.
 - e. Remove the bore sighter from the muzzle. You are ready for zeroing the target.
2. Zeroing on the Target
 - a. Place a target 100 yards away (35 yards for air gun).
 - b. Ideally, use a steadying device such as a shooting stand or bipod, set the scope at highest magnification, aim at the center of the target, fire a test shot, if safe to do so.
 - c. If the impact point of the pellet or bullet is exactly in the center of the target then the scope is zeroed. If not, you will need to adjust the reticle using the elevation and/or windage adjustment as follows:
 - d. Vertical adjustment (Elevation) – Use your fingers to turn the adjusting knob as required. One click in either direction equals approximately 1/2, 1/4 or 1/8 inch at 100 yards depending the model.
 - e. Horizontal adjustment (Windage) - Use your fingers to rotate the adjusting knob as required. One click in either direction equals approximately 1/2, 1/4 or 1/8 inch at 100 yards depending the model.
 - f. Having adjusted the windage and elevation as required, fire, if safe to do so, another test shot. Keep adjusting and test firing until the test shot hit the target center.
 - g. Now the scope should be zeroed. Make sure to lock both elevation and windage knobs.

ZERO RESETTING

Once your scope is zeroed, push down both knobs and make sure they are fully locked. The "0" marking may not be facing you at the original center position now. Optionally, you can use the following steps to reset zero by rotating the "0" marking to the center positions:



1. Use the Allen wrench provided to turn both Zero Resetting Hex Screws on the side of the knob counterclockwise for 1 to 2 turns to dis-engage the W/E knobs. When a knob is "dis-engaged", the top cap of the knob can freely spin without reticle movement. (IMPORTANT: Be gentle with the screw movement. Do not over extend the rotation. Stop when the W/E knob is dis-engaged)
2. When the W/E knob is dis-engaged, rotating the knob will not produce any clicking sound and will not affect zero. You can re-position the "0" marking to the center position. (If you get clicks when rotating the W/E knob, the knob was not properly disengaged. You need to go back and re-start from zeroing your scope before you lock zero and do zero-reset again.)
3. Use the Allen wrench to gently tighten down the Zero Resetting Hex Screws to complete Zero Resetting. (If you get clicks while tightening the screw, you will need to go back and re-start from zeroing your scope before you lock zero and do zero-reset again.)

★ K-4., K-5., K-6. W/E Operation

WINDAGE/ELEVATION DIALING INSTRUCTION



K-4.
Use a flat head screwdriver to adjust the windage and elevation.

K-5.
Apply gentle force on the rim and dial the knob.

K-6.
Apply gentle force on the plastic tab and dial the knob.

ZEROING - Unscrew and remove the cap of the adjustment knob. Put the cap away in a safe place.

1. **Zeroing with a Bore Sighter**
 - a. When the turret is ready for adjustment, you will be able to dial and have a clear audible click.
 - b. Follow the instruction of your bore sighter and install it in the muzzle of your rifle, lining it with the scope as closely as possible.
 - c. If applicable, turn on the illumination and set it at your preferred color and brightness.
 - d. Sighting through the scope as though you were going to shoot and dial the knobs to make adjustment for the elevation and/or windage until the crosshair matches the bore sighter.
2. **Zeroing on a Target**
 - a. Place a target 100 yards away (35 yards for air gun).
 - b. Use a steadying device such as a shooting stand or bipod, set the illumination to your prefer settings, aim at the center of the target and fire a test group shot, if safe to do so.
 - c. If the impact point of the test shot is exactly in the center of the target then the scope is zeroed. If not, you will need to adjust the reticle using the elevation and/or windage adjustment. Follow the Point of Impact (POI) direction on the turret to dial the knob accordingly.
 - d. Having adjusted the elevation and windage as required, fire, if safe to do so, another test group. Keep adjusting and test firing until the test shot hit the target center in an acceptable small grouping.
3. Now the scope should be zeroed. Make sure to replace both elevation and windage knob caps.

★ K-7. Lockable W/E Operation

The Windage and Elevation Adjustment Target Knobs have a unique Locking Screw design. An Allen Wrench is provided with the scope for adjustment.

WARNING:

DO NOT over-loosen the locking screws! It may cause the face cover to fall off if screws are backed out too far. If, by mistake, the face lid fell off when you were loosening the screws, please follow instructions below to replace the face cover.

- Lock both screws down, making sure that they are flush with the surface.
- Apply a little loctite or similar adhesive on the flat surface of the knob. Make sure that no adhesive gets into the screw holes or onto the screws.
- Carefully place the face cover back on the knob and align with the locking holes properly. Firmly press the face cover to achieve full contact and wait a few seconds to let the cover adhere to the flat surface of the knob.

ZERO LOCKING (The windage/elevation knobs are in the LOCKED position for a new scope out of the factory.)

- Unscrew and remove the cap of the adjustment knob. Put the cap away in a safe place. Gently dial the knob and test if it is locked. If not, you can skip section ii.
- To Unlock: Locate the two locking screws as shown on the right. Use the included small Allen wrench to unlock both locking screws by turning them counterclockwise 1/4 revolution.
- To Lock: Use the included small Allen wrench to fully lock down both screws by turning them clockwise. It is recommended that you gradually lock both screws alternately until they are fully and evenly locked.



ZEROING - Unlock the adjustment knob to allow for adjustment.

- Zeroing with a Bore Sighter
 - When the turret is ready for adjustment, you will be able to dial and have a clear audible click.
 - Follow the instruction of your bore sighter and install it in the muzzle of your rifle, lining it with the scope as closely as possible.
 - If applicable, turn on the illumination and set it at your preferred color and brightness.
 - Sighting through the scope as though you were going to shoot and dial the knobs to make adjustment for the elevation and/or windage until the crosshair matches the bore sighter.
- Zeroing on a Target
 - Place a target 100 yards away (35 yards for air gun).
 - Use a steady device such as a shooting stand or bipod, set the illumination to your prefer settings, aim at the center of the target and fire a test group shot, if safe to do so.
 - If the impact point of the test shot is exactly in the center of the target then the scope is zeroed. If not, you will need to adjust the reticle using the elevation and/or windage adjustment. Follow the Point of Impact (POI) direction on the turret to dial the knob accordingly.
 - Having adjusted the elevation and windage as required, fire, if safe to do so, another test group. Keep adjusting and test firing until the test shot hit the target center in an acceptable small grouping.
 - Now the scope should be zeroed. Make sure to lock both elevation and windage knobs and replace the knob caps.

L. REMOVING AND INSTALLING LENS CAPS

(For Models with Detachable Lens Caps Only)

Lens caps are designed with grooved inner surface to tightly fit over the scope objective and eyepiece.



- To remove, grab the lens cap firmly and pull it off the scope. Wiggle the cap gently if necessary to help slide it off.
- To install, align grooves in the cap with the scope surface and gradually push the cap toward the scope until it is completely seated.

M. INSTALLING SUNSHADE

(For Models with Detachable Sunshade Only)



- Remove the lens cap from the objective lens.
- Unscrew the objective lens's thread protector by unscrewing it counterclockwise. (Not all models have a thread protector. Skip this step if not applicable)
- Screw on the correctly compatible sunshade to the front of the objective lens by threading the sunshade clockwise until tightened and fully secured.
- Screw the objective lens's thread protector onto the front of the now installed sunshade. (Skip this step if not applicable)

N. CARE AND MAINTENANCE

- Take care not to drop or knock the scope once it is zeroed.
- Keep the protective lens covers in place when the scope is not being used.
- Maintain the metal surface of the scope by removing any dirt or sand with a soft brush so as to avoid scratching the finish.
- Wipe the lens with a clean flannel cloth to keep it clean and dry. In order to avoid scratching the glass, ensure both the lens and cloth are clean. Do not use finger or finger nail to touch/clean lenses.
- Store the scope in a cool dry place when not in use. Be careful to avoid contact with acid, alkaline or corrosive chemicals. Remove battery if the scope is being stored away for an extended period of time.
- Do not attempt to lubricate any part of the scope.
- Do not disassemble the scope. Any such action will void the warranty.

CAUTION: Viewing the sun can cause serious eye injury. Never look directly into the sun with this or any scope.

O. LIMITED LIFETIME MANUFACTURER'S WARRANTY

Warranty against material or workmanship defects applies based on the following conditions -

- Product is a firsthand purchase. Evidence in the form of a purchase receipt, invoice, etc. is required for warranty service. Warranty is not transferable.
- Product is not disassembled and the product is not tampered with in any way. Any evidence of such will void the warranty.
- Scope has not been abused, maliciously damaged or treated in a manner not in keeping with the purpose it was designed for.

For warranty service, please contact the scope distributor and provide a written problem description to obtain a Return Authorization Number before returning the product for repair or replacement.

EXPLORE MORE AT

WWW.LEAPERS.COM

Leapers, Inc., headquartered in Michigan, U.S.A., has been in the business of supplying shooting, hunting and outdoor gear since 1992. We set un-compromised high standards for all of our business operations. Our goal is to provide a total solution for any line of products we offer. We pay close attention to industry trends and customer feedback, with a focus on making the best-in-class niche products available for hunting, shooting and outdoor enthusiasts like you.



www.LEAPERS.com
32700 Capitol Street
Livonia, MI 48150 U.S.A.
Tel:(734)542-1500
Fax:(734)542-7095
Email:office@leapers.com