

- ☒ = Schleifz.
- * = 0.5 mm
- = 0.5x45°
- × = 1 x45°
- = 1.5x45°
- ▽ = 2 x45°
- = R 0.5
- ⊗ = R 1
- = R 1.5
- r = R 2
- R = R 2.5

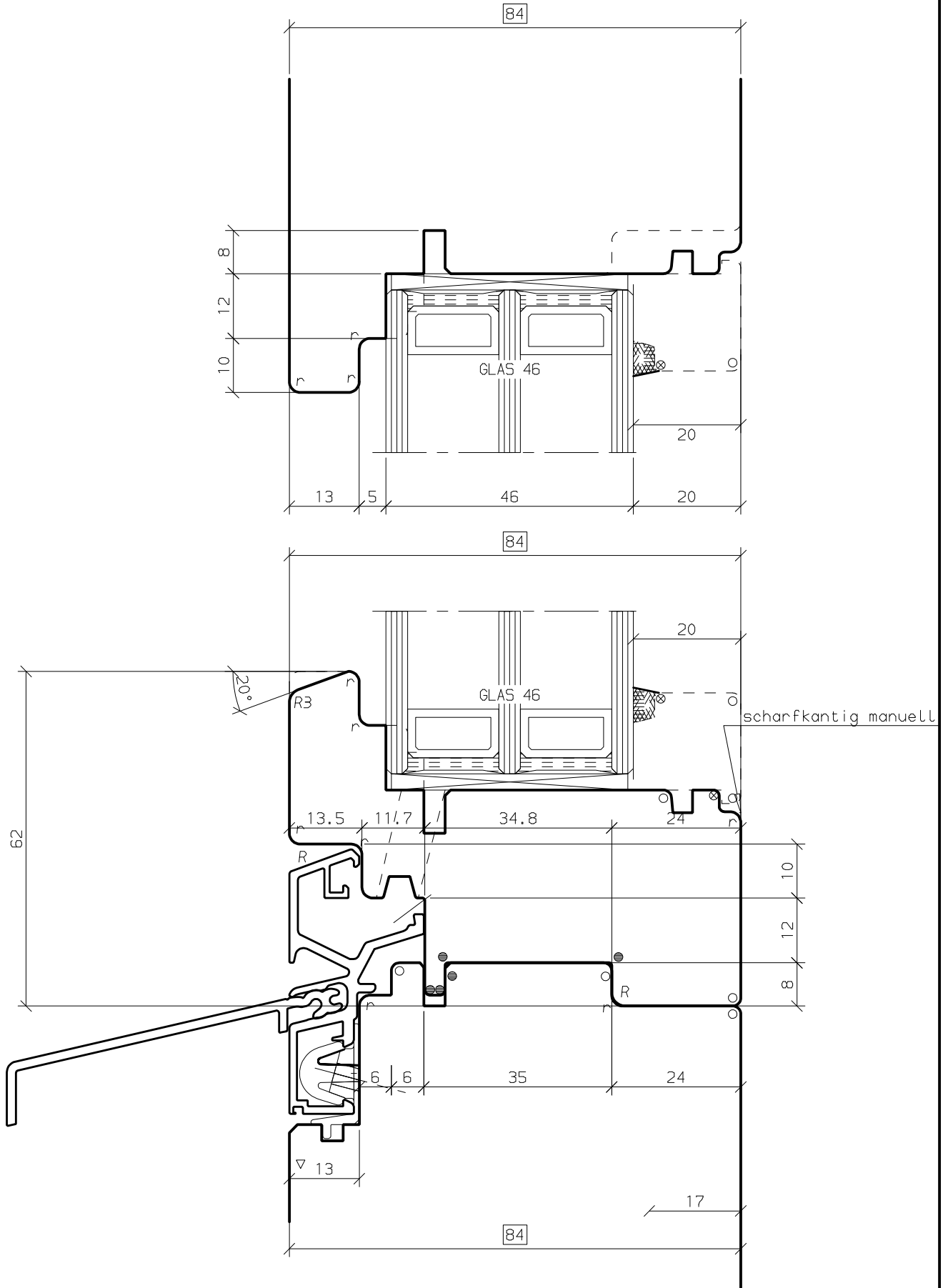

OERTLI 

SIRIUS H 84
FESTVERGLASUNG MIT EINLEIMER

Maßstab 1:1 A4 Gez. 15.03.18 LA0

K-Nr. 1001108 Gepr. . . .

K-Name SCHREINEREI WEBER, SEEWEN

QD 1518964 200 01 A

Ers.d.:
 Ers.f.:

- ☒ = Schleifz.
- * = 0.5 mm
- = 0.5x45°
- X = 1 x45°
- = 1.5x45°
- ▽ = 2 x45°
- ⊙ = R 0.5
- ⊗ = R 1
- = R 1.5
- r = R 2
- R = R 2.5

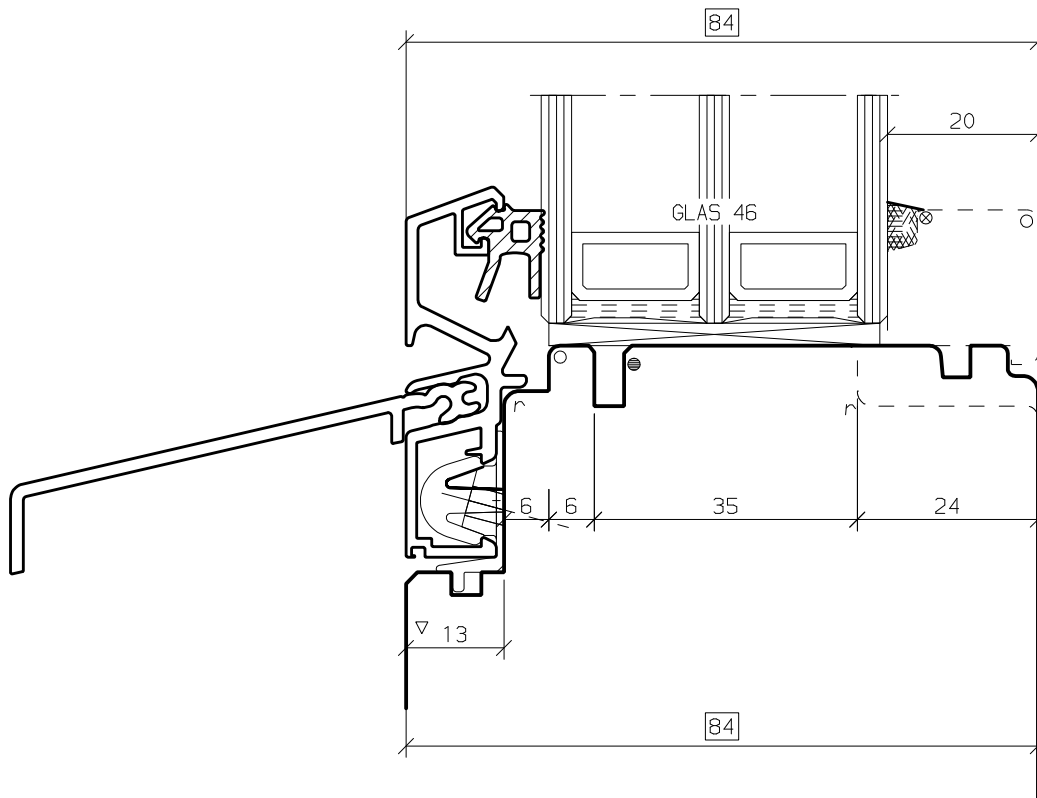
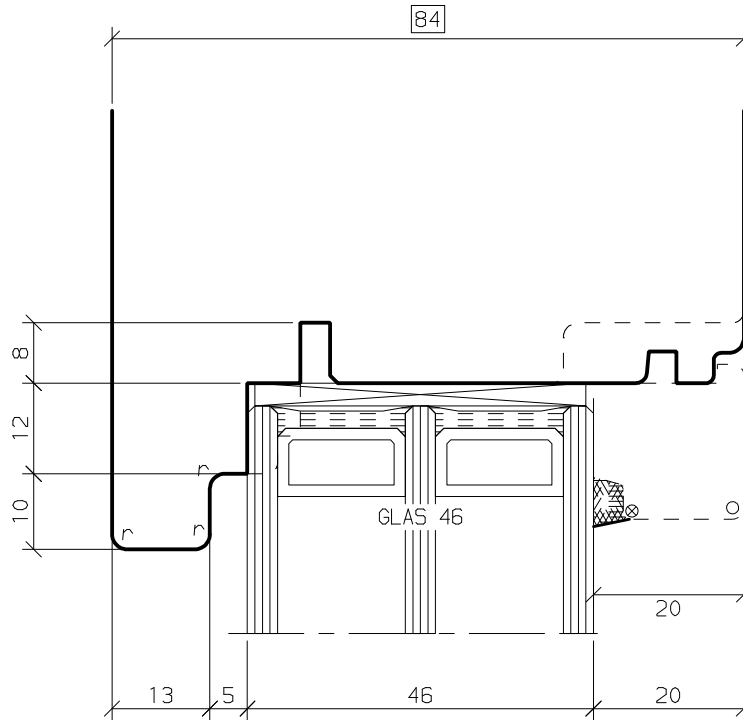

OERTLI 

SIRIUS H 84
FESTVERGLASUNG OHNE EINLEIMER

Maßstab 1:1 **A4** Gez. 15.03.18 LA0

K-Nr. 1001108 Gepr. . . .

K-Name SCHREINEREI WEBER, SEEWEN

QD 1518964 201 01 A

Ers.d: .
 Ers.f: .

- ☒ = Schleifz.
- * = 0.5 mm
- = 0.5x45°
- X = 1 x45°
- = 1.5x45°
- ▽ = 2 x45°
- = R 0.5
- ⊗ = R 1
- = R 1.5
- r = R 2
- R = R 2.5

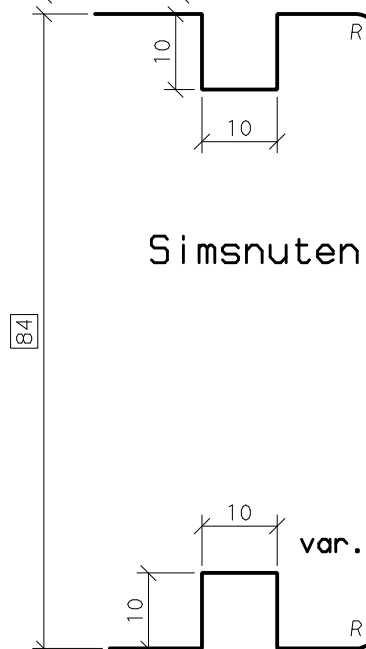
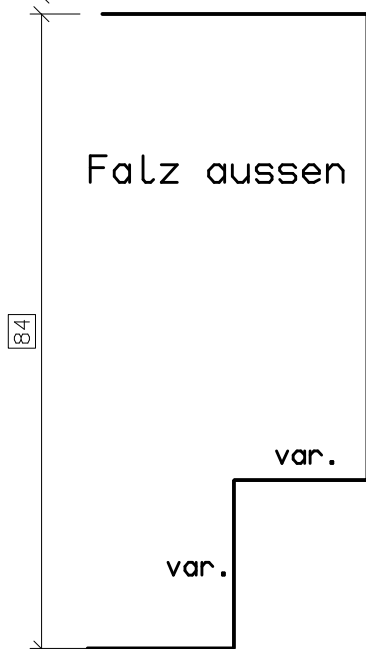
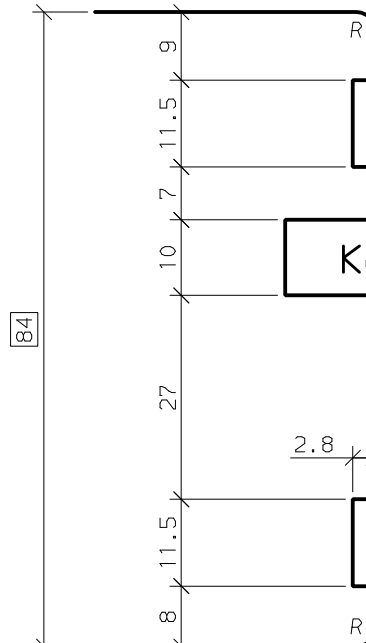
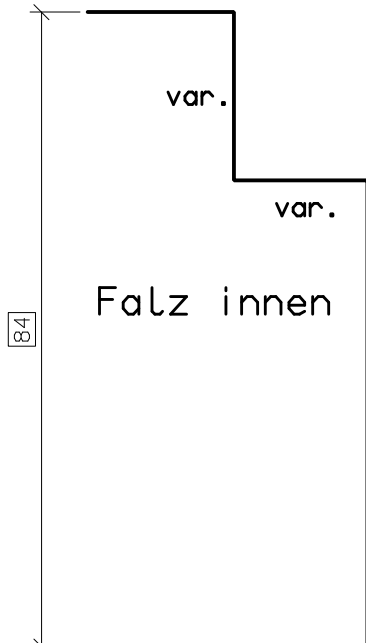
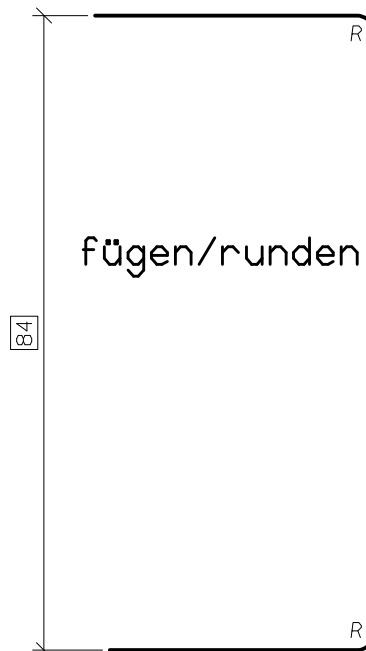
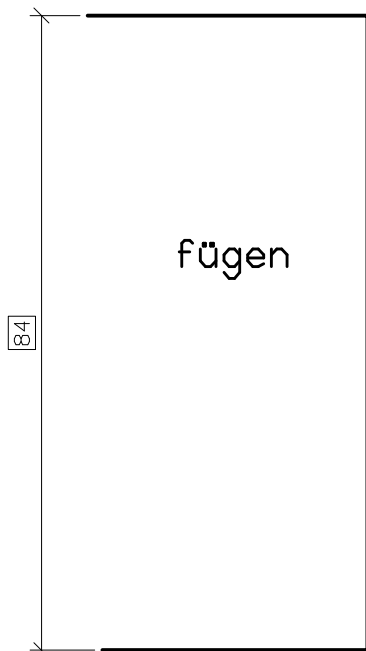

OERTLI

RAHMENAUSSENBEARBEITUNGEN
HD 84MM

Maßstab 1:1 **A4** Gez. 15.03.18 LA0

K-Nr. 1001108 Gepr. . .

K-Name SCHREINEREI WEBER, SEEWEN

QD 1518964 209 01 A

Ers.d: .
 Ers.f: .