

ADVANCED EQ

EQ-20

GRAPHIC EQUALIZER

Owner's Manual

Thank you, and congratulations on your choice of BOSS EQ-20 Graphic Equalizer.

Before using this unit, carefully read the sections entitled: "USING THE UNIT SAFELY" and "IMPORTANT NOTES" (p. 24–26; p. 2–3).

These sections provide important information concerning the proper operation of the unit. Additionally, in order to feel assured that you have gained a good grasp of every feature provided by your new unit, Owner's manual should be read in its entirety. The manual should be saved and kept on hand as a convenient reference.

Main Features

- This is a 10-band graphic equalizer that lets you vary levels by +/-15 dB from 30 Hz to 12 kHz.
- You can use pedal operations to switch between "MANUAL," which offers equalization based on the positions of the controls; and "MEMORY," which can store nine different equalization setups in memory. The superior functionality of the unit really becomes evident at those times when you need to change settings instantly, such as for lead guitar, for cutting, or for booster.
- Features an LCD screen for graphic display of the equalization setups stored in "MEMORY." The screen has a handy backlit for use on stage and in dark locations.
- Supports guitar amp send/return (+4 dBu input and output). This makes preamp sound correction possible.
- Uses a diecast body offering outstanding strength and durability.
- Can run on battery power (six AA type).

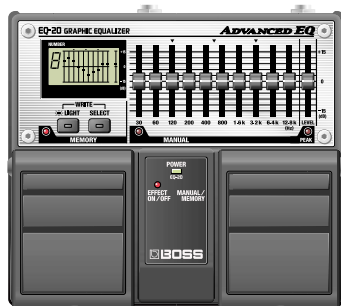

Copyright © 2000 BOSS CORPORATION

All rights reserved. No part of this publication may be reproduced in any form without the written permission of BOSS CORPORATION.

IMPORTANT NOTES

In addition to the items listed under “USING THE UNIT SAFELY” on page 24, please read and observe the following:

Power Supply: Use of Batteries

- Do not use this unit on the same power circuit with any device that will generate line noise (such as an electric motor or variable lighting system).
- The AC adaptor will begin to generate heat after long hours of consecutive use. This is normal, and is not a cause for concern.
- The use of an AC adaptor is recommended as the unit's power consumption is relatively high. Should you prefer to use batteries, please use the alkaline type.
- Batteries should always be installed or replaced before connecting any other devices. This way, you can prevent malfunction and/or damage to speakers or other devices.
- Batteries are supplied with the unit. The life of these batteries may be limited, however, since their primary purpose was to enable testing.
- Before connecting this unit to other devices, turn off the power to all units. This will help prevent malfunctions and/or damage to speakers or other devices.

Placement

- Using the unit near power amplifiers (or other equipment containing large power transformers) may induce hum. To alleviate the problem, change the orientation of this unit; or move it farther away from the source of interference.
- This device may interfere with radio and television reception. Do not use this device in the vicinity of such receivers.
- To avoid possible breakdown, do not use the unit in a wet area, such as an area exposed to rain or other moisture.

Maintenance

- For everyday cleaning wipe the unit with a soft, dry cloth or one that has been slightly dampened with water. To remove stubborn dirt, use a cloth impregnated with a mild, non-abrasive detergent. Afterwards, be sure to wipe the unit thoroughly with a soft, dry cloth.
- Never use benzine, thinners, alcohol or solvents of any kind, to avoid the possibility of discoloration and/or deformation.

Additional Precautions

- Please be aware that the contents of memory can be irretrievably lost as a result of a malfunction, or the improper operation of the unit. To protect yourself against the risk of losing important data, we recommend that you periodically save a backup copy of important data you have stored in the unit's memory on a paper.
- Unfortunately, it may be impossible to restore the contents of data that was stored in the unit's memory once it has been lost. Roland Corporation assumes no liability concerning such loss of data.
- Use a reasonable amount of care when using the unit's buttons, sliders, or other controls; and when using its jacks and connectors. Rough handling can lead to malfunctions.
- Never strike or apply strong pressure to the display.
- When connecting / disconnecting all cables, grasp the connector itself—never pull on the cable. This way you will avoid causing shorts, or damage to the cable's internal elements.
- To avoid disturbing your neighbors, try to keep the unit's volume at reasonable levels. You may prefer to use headphones, so you do not need to be concerned about those around you (especially when it is late at night).
- When you need to transport the unit, package it in the box (including padding) that it came in, if possible. Otherwise, you will need to use equivalent packaging materials.

Installing Batteries

Insert the included batteries as shown in figure, being careful to orient the batteries correctly.

* Make sure the “+” and “-” ends of the batteries are oriented correctly.

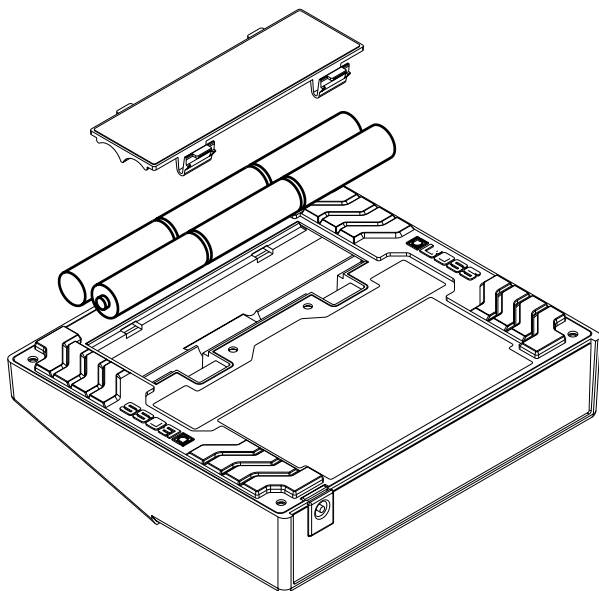

When the batteries run down, the POWER indicator gets dim. If this happens, replace with new batteries.



NOTE When replacing the batteries, use six AA type.

- * Since the EQ-20's current consumption is relatively high, we recommend the use of alkaline batteries.
- * Do not mix fresh batteries with used ones, or mix batteries of different types. Doing so can result in fluid leakage.
- * Battery life can vary depending on battery type.



Continuous usage time under battery power is about 12 hours with alkaline batteries and about 3.5 hours with carbon batteries. (This may vary according to usage conditions.)

Making the Connections

Connecting to the Guitar/Bass Amplifier

- * When the unit is running on battery power, the power comes on when you insert the connector plug into the INPUT jack.
- * Before connecting or disconnecting the cord, be sure to lower the volume on the amp.
- * To prevent malfunction and/or damage to speakers or other devices, always turn down the volume, and turn off the power on all devices before making any connections.
- * If there are batteries in the unit while an AC adaptor is being used, normal operation will continue should the line voltage be interrupted (power blackout or power cord disconnection).
- * Once you've gotten hooked up correctly (p. 5–6), be sure to observe the following order when switching on the power to your equipment. By turning on devices in the wrong order, you risk causing malfunction and/or damage to speakers and other devices.
When powering up: Turn on the power to your guitar amp (or the like) **last**.
When powering down: Turn off the power to your guitar amp (or the like) **first**.
- * Always make sure to have the volume level turned down before switching on power. Even with the volume all the way down, you may still hear some sound when the power is switched on, but this is normal, and does not indicate a malfunction.
- * When operating on battery power only, the unit's indicator will become dim when battery power gets too low. Replace the battery as soon as possible.

Connecting to Normal Input on the Guitar/Bass Amp

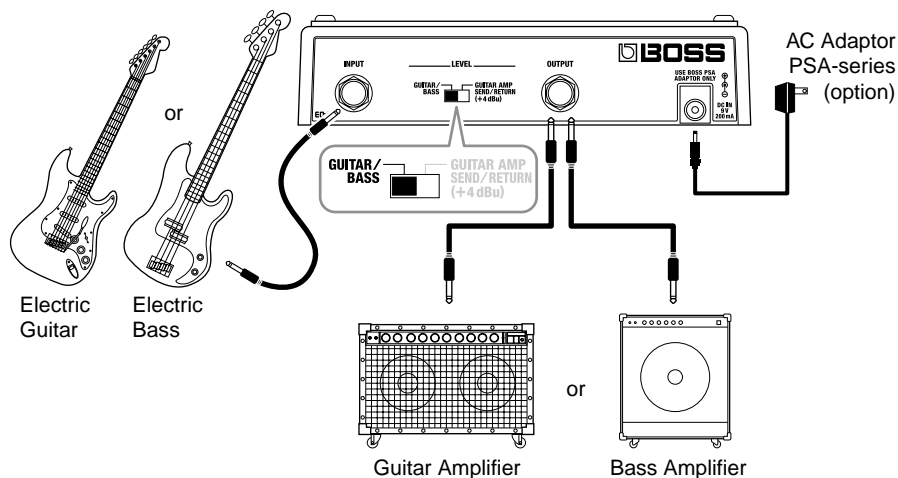

Connecting to SEND/RETURN on the Guitar Amp

The unit's equalization effects are obtained after the preamp.

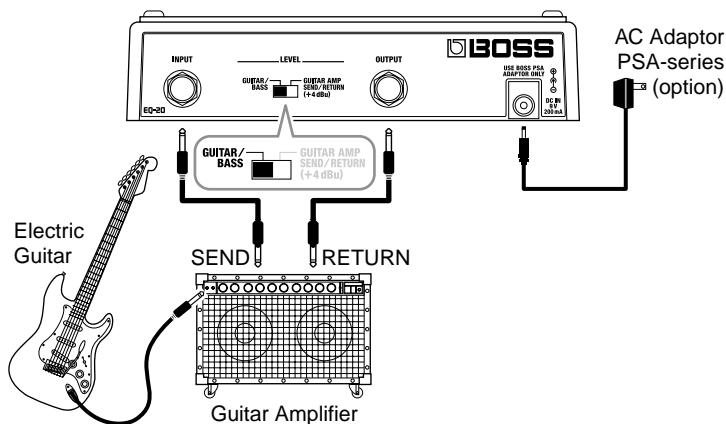

- * Match the send output level on the guitar amp and the level setting on the unit. If the PEAK indicator lights up frequently, turn down the output on the guitar amp.
- * When the guitar amp's SEND/RETURN pedal is at +4 dBu, set the LEVEL switch on the rear panel of the unit to +4 dBu.

Connecting to an MTR or Mixer

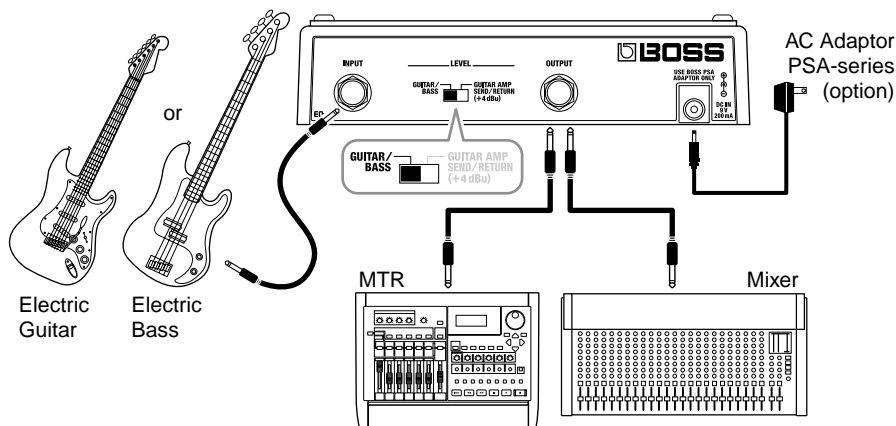

Operation

When you switch on the power, the unit is set to the state it was in when the power was last switched off (MANUAL/MEMORY, Memory Number).

Pedal Operation

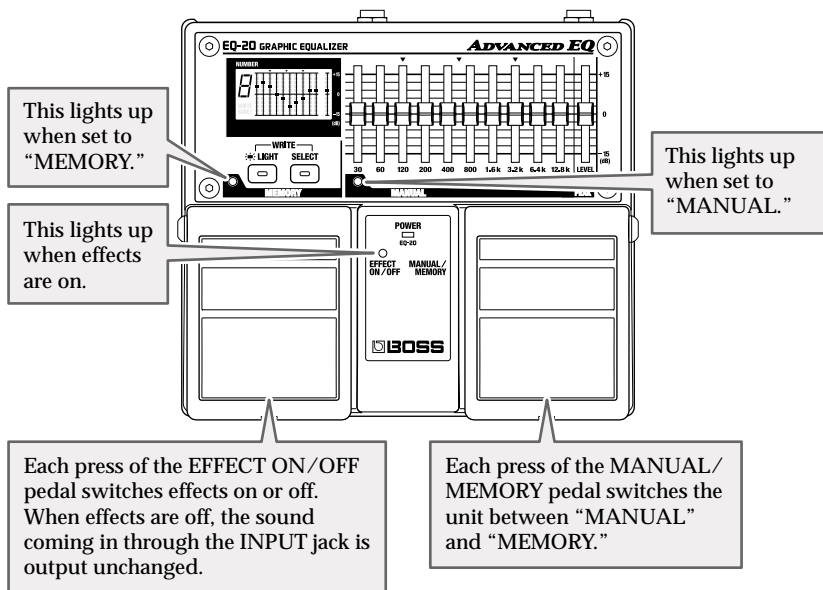

Panel Operation

When Set to "MANUAL"

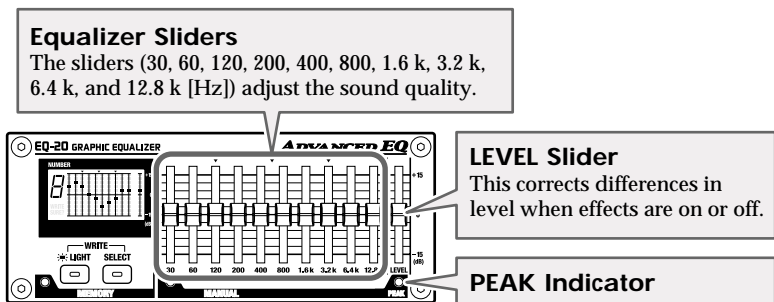

* If the PEAK indicator lights up frequently, switch the LEVEL switch on the rear panel of the unit.

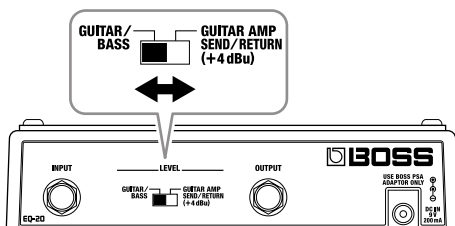

Before you operate the LEVEL switch, be sure to turn down the volume on all equipment to prevent malfunction or speaker damage.



When set to MANUAL, the backlit does not light up even when the equalizer sliders, the LEVEL slider, or the EFFECT ON/OFF pedal are operated.

When Set to “MEMORY”

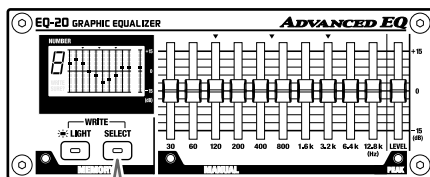

SELECT Button

Pressed to select a memory location (1 through 9).
Holding down the button makes the memory number change automatically.

When the unit is shipped from the factory, equalization settings are stored in memories 1 through 9. For information about the settings, refer to “Factory Default Settings” (p. 17).

Storing Settings (Write Operation)



Even when you carry out a write operation while the MEMORY indicator is lighted (“MEMORY”), settings made for “MANUAL” are not stored. Be sure to carry out such operations when the MANUAL indicator is lighted (in the “MANUAL” mode).



Do not switch off the power while a write operation is in progress.

1. While at “MANUAL,” adjust the equalizer sliders and the level slider to obtain the desired equalization.

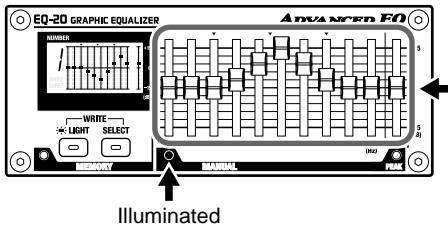

2. Press the LIGHT button and the SELECT button at the same time.

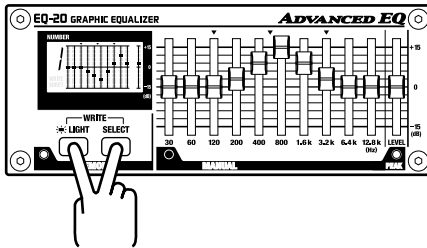

The text “WRITE SURE?” flashes in the display, and the unit enters write standby.

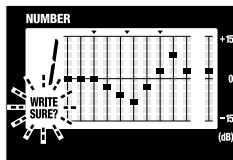

* To cancel the write operation, press the MANUAL/MEMORY pedal.

- Press the SELECT button to choose the number of the memory (1 through 9) to store the settings.



To avoid deleting previously stored settings, check the display before overwriting.

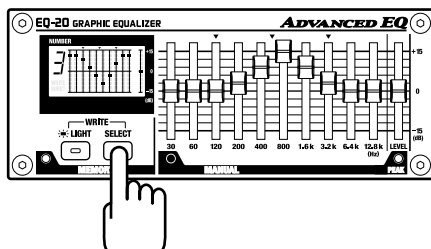

- Again press the LIGHT button and the SELECT button at the same time. "OK" appears in the display and the write operation finishes.

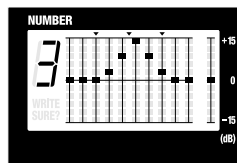
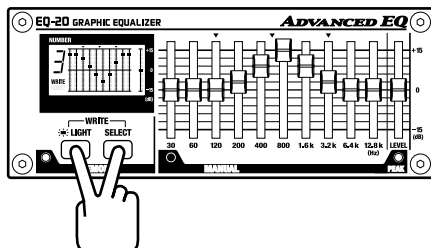

- * From step 2 and after, you cannot adjust the sound quality or volume level by moving the sliders.
- * If you want to change what is in memory, refer to "Changing What Is in Memory Before Storing" (p. 12).
- * If you want to return the settings to the factory defaults, refer to "Returning Settings to Their Factory Defaults" (p. 16).

Changing What Is in Memory Before Storing

NOTE Do not switch off the power while a write operation is in progress.

1. Press the MANUAL/MEMORY pedal to change to the “MEMORY.”

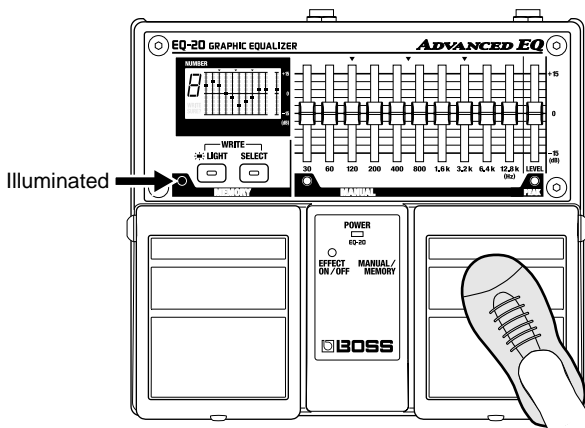

2. Press the SELECT button to choose the number of the memory you want to change.

* Holding down the SELECT button makes the memory number change automatically.

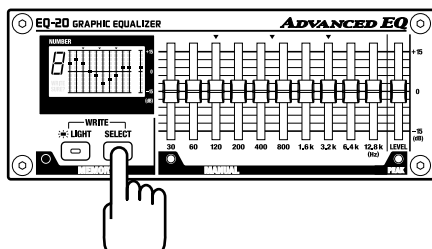

3. Operate the equalizer sliders or the level slider to change the equalization. The display shows the positions of the sliders stored in memory. When you operate the sliders, the present positions (settings) flash until they match the setup stored in memory.

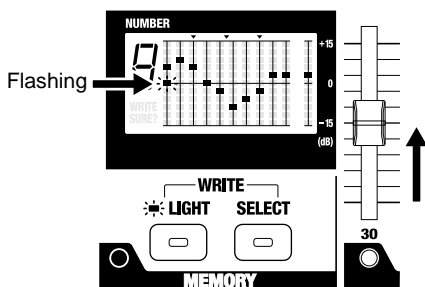

The unit enters a state where you can make changes from when the positions of the sliders stored in memory and the present slider positions match, and the sound quality and levels start to change.

* *It only flashes once, even if you move more than one slider at the same time. Move the sliders one at a time to make the settings.*

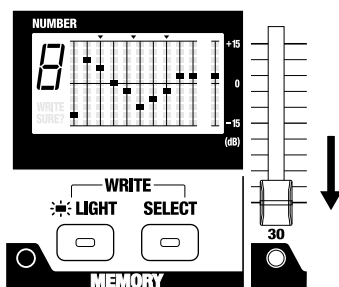

4. Press the LIGHT button and the SELECT button at the same time. The text "WRITE SURE?" flashes in the display, and the unit enters write standby.

* *To cancel the write operation, press the MANUAL/MEMORY pedal.*



If only the SELECT button is pressed, the display changes to show the contents of the next memory number, and the changes made in change 3 are canceled.

5. Press the SELECT button to choose the number of the memory (1 through 9) to store the settings.
6. Again press the LIGHT button and the SELECT button at the same time. "OK" appears in the display and the write operation finishes.



By changing the level of the setup in memory and writing it to a different memory, you can create a booster, where the equalizer settings stay the same and the level is raised.

Part Names and Functions

Front Panel

Display

This displays the memory number (1 through 9) and the settings in it.



This lights up when you turn on the power or manipulate the memory section, then goes dark about 20 seconds after you stop operation. This is a feature that helps save battery power. If you want it illuminated constantly, press the LIGHT button to make it light up.

** Please be aware that the batteries may run down faster than normal.*

Equalizer Sliders

Provide for adjustment at 30 Hz, 60 Hz, 120 Hz, 200 Hz, 400 Hz, 800 Hz, 1.6 kHz, 3.2 kHz, 6.4 kHz, and 12.8 kHz within a range of plus or minus 15 dB.

Level Slider

This corrects differences in level relative to whether effects are on or off within a range of plus or minus 15 dB.

SELECT Button

This changes the memory number. Hold down to change rapidly.

MEMORY Indicator

This lights up when set to "MEMORY."

LIGHT Button

This turns the display backlight on and off.

EFFECT ON/OFF Pedal

Each press of the pedal switches the effects on or off.

EFFECT ON/OFF Indicator

This lights up when effects are on.

MANUAL/MEMORY Pedal

Each press of the pedal switches between "MANUAL" and "MEMORY."

PEAK Indicator

This lights up when the signal is at 6 dB before clipping.

MANUAL Indicator

This lights up when set to "MANUAL."

POWER Indicator

This lights up when the power is on. If this gets dim or fails to light up when the unit is running on battery power, it means that the batteries are depleted. Replace promptly with fresh batteries.



"Installing Batteries" (p.4)

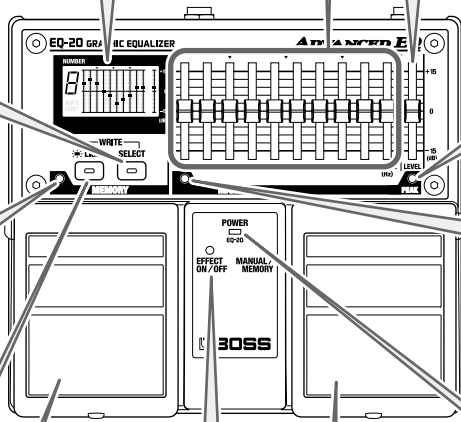

Rear Panel

INPUT Jack

This is the input jack for connecting to the output of an electric guitar/bass or other instrument or effects processor.

** The INPUT jack also doubles as the power switch when the unit is running on battery power. The power comes on when a plug is inserted into the INPUT jack, and goes off when it is unplugged. Unplug any connected cords when the unit is not in use.*

OUTPUT Jack

This jack is for connection to a guitar/bass amp, another effects processor, mixer, MTR, or the like.

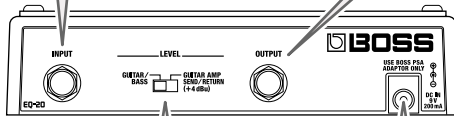

LEVEL Switch

This switch sets the input level to correspond to the device connected to the INPUT jack.

GUITAR/BASS:

When using an electric guitar or bass guitar

GUITAR AMP SEND/RETURN:

When connected to send or return on a guitar amp or the like, or when connected to a large-volume output device



“Making the Connections” (p. 5–6)

AC ADAPTOR Jack

This jack is for connecting an AC adaptor (BOSS PSA-series, sold separately). Using an AC adaptor makes possible long performances with no worry about batteries going dead.

Returning Settings to Their Factory Defaults

You can return the settings in memories 1 through 9 to their factory defaults.



When this operation is carried out, everything that is now in memory is lost.

1. Switch off the power.

When running on battery power:

Disconnect the connection plug from the INPUT jack.

When running on power from an AC adaptor:

Disconnect the plug from the AC ADAPTOR jack.

2. While holding down the LIGHT button and the SELECT button, switch on the power.

When running on battery power:

Insert the connection plug into the INPUT jack.

When running on power from an AC adaptor:

Insert the AC adaptor plug into the AC ADAPTOR jack.

When you release the button, "REST" appears on the display.

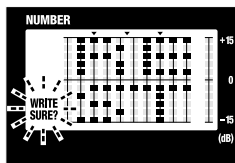

** To cancel the operation, press the LIGHT button, the SELECT button, or the left or right pedal.*

3. Press the LIGHT button and the SELECT button at the same time.
"OK" appears in the display and the settings return to their factory defaults.

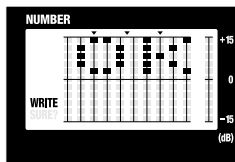

Factory Default Settings

NUMBER 1

Guitar Clean Cutting

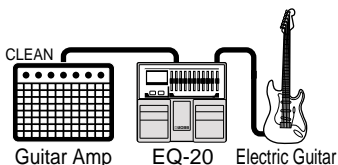
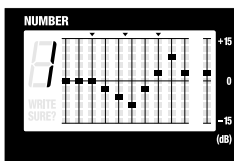

NUMBER 2

Mid Boost for the Lead

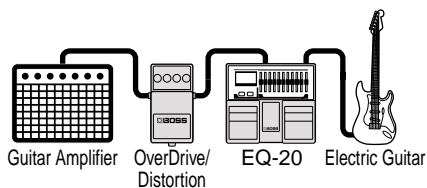
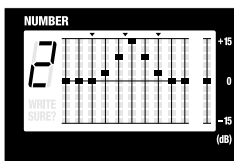

NUMBER 3

Slash/Metal

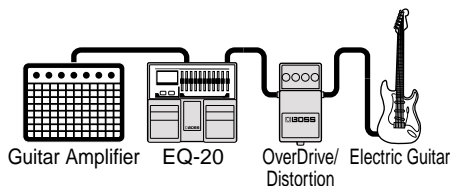
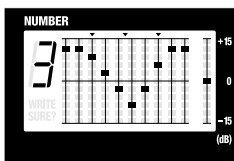

NUMBER 4
Acoustic

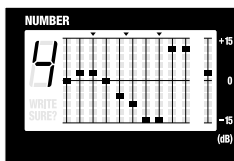

NUMBER 7
For Slap Bass

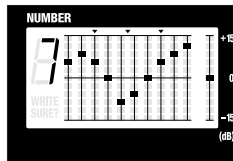

NUMBER 5
Jazz Guitar

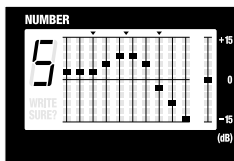

NUMBER 8
For Standard Rock (for Bass)

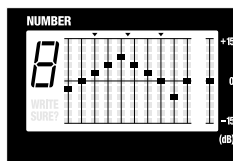

NUMBER 6
Enhancer

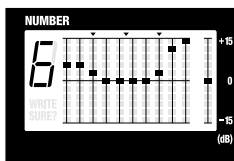

NUMBER 9
Metal (for Bass)

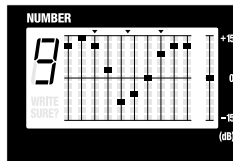

Frequency Response

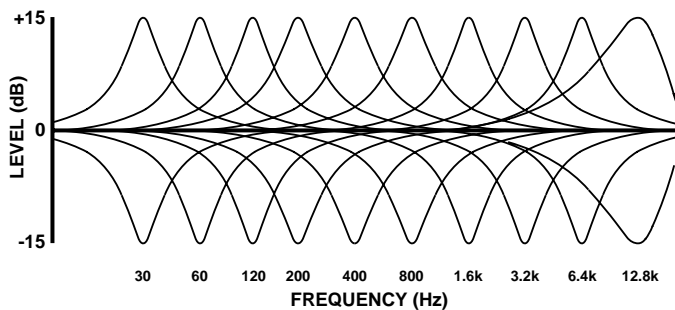

Sample Settings

Settings for Guitar

Booster (connection order: EQ-20 → OverDrive/Distortion)

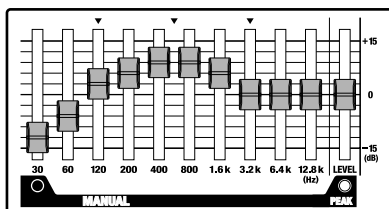

Crunch Sound (connection order: OverDrive/Distortion → EQ-20)

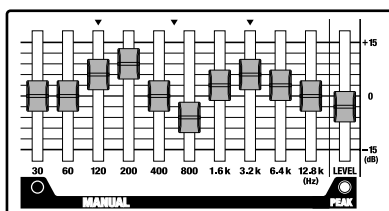

Pickup Simulation (Single-coil → Humbucking)

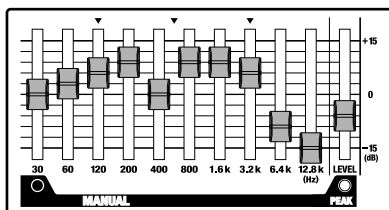

Pickup Simulation (Humbucking → Single-coil)

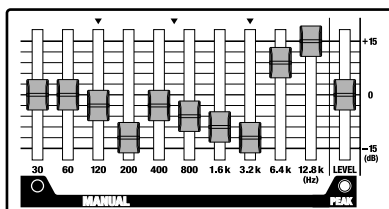

Settings for Bass

Mid Booster

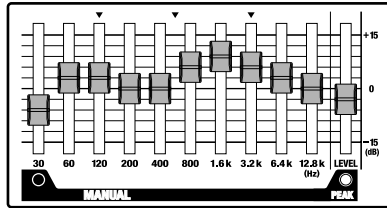

Fat Sound

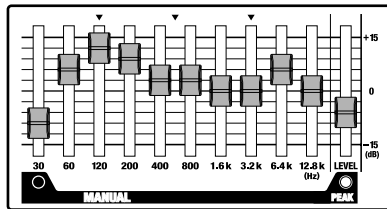

Booster (using the overdrive of the bass amplifier)

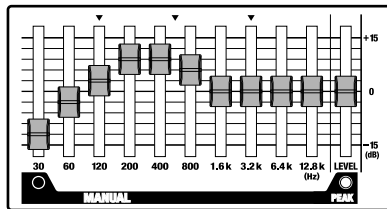

Tight Sound

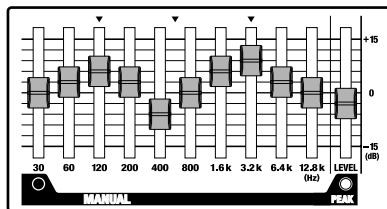

Specifications

EQ-20: Graphic Equalizer

Memories

9

Nominal Input Level

-20 dBu (GUITAR/BASS)

+4 dBu (GUITAR AMP SEND/RETURN)

Input Impedance

1 M Ω

Nominal Output Level

-20 dBu (GUITAR/BASS)

+4 dBu (GUITAR AMP SEND/RETURN)

Output Impedance

1 k Ω

Recommended Load Impedance

10 k Ω

Residual Noise Level

-100 dBu or less (IHF-A typ.)

(All Sliders max.)

Variable Range

Equalizer Control: ± 15 dB

Level Control: ± 15 dB

Display

Custom LCD (backlit LCD)

Controls

EFFECT ON/OFF Pedal

MANUAL/MEMORY Pedal

Equalizer Sliders

(30 Hz, 60 Hz, 120 Hz, 200 Hz, 400 Hz,

800 Hz, 1.6 kHz, 3.2 kHz, 6.4 kHz, 12.8 kHz)

LEVEL Slider

SELECT Button

LIGHT Button

LEVEL Switch

Indicators

POWER Indicator

(serves also as battery check indicator)

EFFECT ON/OFF Indicator

MANUAL Indicator

MEMORY Indicator

PEAK Indicator

Connectors

INPUT Jack

OUTPUT Jack

AC Adaptor Jack

Power

DC 9V: Dry battery (AA type) x 6, AC Adaptor

Power Consumption

120 mA (9 V)

* *Expected battery life under continuous use:*

Carbon: 3.5 hours

Alkaline: 12 hours

These figures will vary depending on the actual conditions of use.

Dimensions

173 (W) x 158 (D) x 57 (H) mm

6-13/16 (W) x 6-1/4 (D) x 2-1/4 (H) inches

Weight

1.1 kg / 2 lbs 7 oz (including batteries)

Accessories

Owner's Manual

Roland Service (Information sheet)

Dry battery (AA type) x 6

* *We recommend that alkaline batteries be used when replacing the batteries.*

Options

AC Adaptor (PSA-series)

* *0 dBu = 0.775 Vrms*



In the interest of product improvement, the specifications and/or appearance of this unit are subject to change without prior notice.

If You Think There's a Problem

The power doesn't come on.

- Is the specified AC adaptor (PSA-series, sold separately) connected correctly?

➔ Check the connections again (p. 5-6).

- Have the batteries run down?

➔ Replace with fresh batteries (p. 4).

- Is the guitar connected correctly to the INPUT jack?

➔ Check the connections again (p. 5-6).

** When running off batteries, the unit won't switch on unless there's something plugged into the INPUT jack. This helps conserve the batteries.*

The settings for "MANUAL" are not stored in memory.

- Is the MEMORY indicator lit up?

➔ If the MANUAL indicator is not lit up (and the unit is not set to "MANUAL"), then settings are not stored in memory even if you carry out a write operation. Get the MANUAL indicator to light up, then carry out the write procedure again (p. 10).

The contents of memory cannot be overwritten.

- Is the MANUAL indicator lit up?

➔ Change settings and store them in memory when the MEMORY indicator is lit up (and the unit is set to "MEMORY") (p. 12).

There is no sound/volume is too low.

- Is the other equipment connected correctly?

➔ Check the connections again (p. 5-6).

- Is the volume turned down on the connected guitar amp, effects processor, or other device?

➔ Check the settings on the connected equipment (p. 5-6).

- Is the LEVEL slider on the EQ-20 lowered?

➔ Operate the LEVEL slider to adjust the volume (p. 8).

- Is the LEVEL switch on the rear panel set correctly?

➔ Set the LEVEL switch to match the connected equipment (p. 5-6).

Sound is distorted.

- Have the batteries run down?

➔ When the batteries run down, the POWER indicator goes out and the unit may not operate correctly. Replace with fresh batteries (p. 4).

- Is the volume of the input sound too high?

➔ Be careful of the volume level when using the EQ-20 after a distortion effect or when the EQ-20 is connected to send or return on a guitar amp.

- Is the LEVEL switch on the rear panel set correctly?

➔ Set the LEVEL switch to match the connected equipment (p. 5-6).

The backlit does not light up.



- Is the MANUAL indicator lit?

➔ When the MANUAL indicator is lit (when set to "MANUAL"), the backlit does not light up even when you operate the equalizer sliders or the LEVEL slider.







USING THE UNIT SAFELY

INSTRUCTIONS FOR THE PREVENTION OF FIRE, ELECTRIC SHOCK, OR INJURY TO PERSONS

About  WARNING and  CAUTION Notices

 WARNING	Used for instructions intended to alert the user to the risk of death or severe injury should the unit be used improperly.
 CAUTION	Used for instructions intended to alert the user to the risk of injury or material damage should the unit be used improperly. * Material damage refers to damage or other adverse effects caused with respect to the home and all its furnishings, as well to domestic animals or pets.

About the Symbols

	The  symbol alerts the user to important instructions or warnings. The specific meaning of the symbol is determined by the design contained within the triangle. In the case of the symbol at left, it is used for general cautions, warnings, or alerts to danger.
	The  symbol alerts the user to items that must never be carried out (are forbidden). The specific thing that must not be done is indicated by the design contained within the circle. In the case of the symbol at left, it means that the unit must never be disassembled.
	The  symbol alerts the user to things that must be carried out. The specific thing that must be done is indicated by the design contained within the circle. In the case of the symbol at left, it means that the power-cord plug must be unplugged from the outlet.

----- ALWAYS OBSERVE THE FOLLOWING -----



WARNING

- Before using this unit, make sure to read the instructions below, and the Owner's Manual. 

- Do not open (or modify in any way) the unit or its AC adaptor. 

- Do not attempt to repair the unit, or replace parts within it (except when this manual provides specific instructions directing you to do so). Refer all servicing to your retailer, the nearest Roland Service Center, or an authorized Roland distributor, as listed on the "Information" page. 

WARNING

- Never use or store the unit in places that are:
 - Subject to temperature extremes (e.g., direct sunlight in an enclosed vehicle, near a heating duct, on top of heat-generating equipment); or are 
 - Damp (e.g., baths, washrooms, on wet floors); or are 
 - Humid; or are
 - Exposed to rain; or are
 - Dusty; or are
 - Subject to high levels of vibration.

- Make sure you always have the unit placed so it is level and sure to remain stable. Never place it on stands that could wobble, or on inclined surfaces. 

WARNING

- Use only the specified AC adaptor (PSA-series), and make sure the line voltage at the installation matches the input voltage specified on the AC adaptor's body. Other AC adaptors may use a different polarity, or be designed for a different voltage, so their use could result in damage, malfunction, or electric shock.



- Do not excessively twist or bend the power cord, nor place heavy objects on it. Doing so can damage the cord, producing severed elements and short circuits. Damaged cords are fire and shock hazards!



- This unit, either alone or in combination with an amplifier and headphones or speakers, may be capable of producing sound levels that could cause permanent hearing loss. Do not operate for a long period of time at a high volume level, or at a level that is uncomfortable. If you experience any hearing loss or ringing in the ears, you should immediately stop using the unit, and consult an audiologist.



- Do not allow any objects (e.g., flammable material, coins, pins); or liquids of any kind (water, soft drinks, etc.) to penetrate the unit.



WARNING

- Immediately turn the power off, remove the AC adaptor from the outlet, and request servicing by your retailer, the nearest Roland Service Center, or an authorized Roland distributor, as listed on the "Information" page when:
 - The AC adaptor or the power-supply cord has been damaged; or
 - Objects have fallen into, or liquid has been spilled onto the unit; or
 - The unit has been exposed to rain (or otherwise has become wet); or
 - The unit does not appear to operate normally or exhibits a marked change in performance.



- In households with small children, an adult should provide supervision until the child is capable of following all the rules essential for the safe operation of the unit.



- Protect the unit from strong impact. (Do not drop it!)



- Do not force the unit's power-supply cord to share an outlet with an unreasonable number of other devices. Be especially careful when using extension cords—the total power used by all devices you have connected to the extension cord's outlet must never exceed the power rating (watts/amperes) for the extension cord. Excessive loads can cause the insulation on the cord to heat up and eventually melt through.



- Before using the unit in a foreign country, consult with your retailer, the nearest Roland Service Center, or an authorized Roland distributor, as listed on the "Information" page.



WARNING

- Batteries must never be recharged, heated, taken apart, or thrown into fire or water.



CAUTION

- The unit and the AC adaptor should be located so their location or position does not interfere with their proper ventilation.



- Always grasp only the plug or the body of the AC adaptor when plugging into, or unplugging from, an outlet or this unit.



- Whenever the unit is to remain unused for an extended period of time, disconnect the AC adaptor.



- Try to prevent cords and cables from becoming entangled. Also, all cords and cables should be placed so they are out of the reach of children.



- Never climb on top of, nor place heavy objects on the unit.



- Never handle the AC adaptor body, or its plugs, with wet hands when plugging into, or unplugging from, an outlet or this unit.



- Before moving the unit, disconnect the AC adaptor and all cords coming from external devices.



- Before cleaning the unit, turn off the power and unplug the AC adaptor from the outlet.



CAUTION

- Whenever you suspect the possibility of lightning in your area, disconnect the AC adaptor from the outlet.



- If used improperly, batteries may explode or leak and cause damage or injury. In the interest of safety, please read and observe the following precautions (p. 4).



- Carefully follow the installation instructions for batteries, and make sure you observe the correct polarity.
- Avoid using new batteries together with used ones. In addition, avoid mixing different types of batteries.
- Remove the batteries whenever the unit is to remain unused for an extended period of time.
- If a battery has leaked, use a soft piece of cloth or paper towel to wipe all remnants of the discharge from the battery compartment. Then install new batteries. To avoid inflammation of the skin, make sure that none of the battery discharge gets onto your hands or skin. Exercise the utmost caution so that none of the discharge gets near your eyes. Immediately rinse the affected area with running water if any of the discharge has entered the eyes.
- Never keep batteries together with metallic objects such as ballpoint pens, necklaces, hairpins, etc.



- Used batteries must be disposed of in compliance with whatever regulations for their safe disposal that may be observed in the region in which you live.



- Should you remove the knobs, make sure to put them in a safe place out of children's reach, so there is no chance of them being swallowed accidentally.





This product complies with the requirements of European Directive 89/336/EEC.

For EU Countries

For the USA

FEDERAL COMMUNICATIONS COMMISSION RADIO FREQUENCY INTERFERENCE STATEMENT

This equipment has been tested and found to comply with the limits for a Class B digital device, pursuant to Part 15 of the FCC Rules. These limits are designed to provide reasonable protection against harmful interference in a residential installation. This equipment generates, uses, and can radiate radio frequency energy and, if not installed and used in accordance with the instructions, may cause harmful interference to radio communications. However, there is no guarantee that interference will not occur in a particular installation. If this equipment does cause harmful interference to radio or television reception, which can be determined by turning the equipment off and on, the user is encouraged to try to correct the interference by one or more of the following measures:

- Reorient or relocate the receiving antenna.
- Increase the separation between the equipment and receiver.
- Connect the equipment into an outlet on a circuit different from that to which the receiver is connected.
- Consult the dealer or an experienced radio/TV technician for help.

Unauthorized changes or modification to this system can void the users authority to operate this equipment.
This equipment requires shielded interface cables in order to meet FCC class B Limit.

For Canada

NOTICE

This Class B digital apparatus meets all requirements of the Canadian Interference-Causing Equipment Regulations.

AVIS

Cet appareil numérique de la classe B respecte toutes les exigences du Règlement sur le matériel brouilleur du Canada.

