

## OWNER'S MANUAL

Thank you for purchasing the Roland Bi-Amp Monitor DS-50A. Before using this unit, carefully read the sections entitled: "IMPORTANT SAFETY INSTRUCTIONS" (p. 2), "USING THE UNIT SAFELY" (p. 3), and "IMPORTANT NOTES" (p. 5). These sections provide important information concerning the proper operation of the unit. Additionally, in order to feel assured that you have gained a good grasp of every feature provided by your new unit, this manual should be read in its entirety. The manual should be saved and kept on hand as a convenient reference.

### Main Features

#### ● In Pursuit of High Sound Quality

The DS-50A powered monitor uses a two-way, bi-amplifier design to achieve high sound quality.

The monitor features a 120-mm LF Driver and a 19-mm soft-dome HF Driver as speakers. The amplification includes 30-watt and 20-watt amplifiers designed to achieve high sound quality.

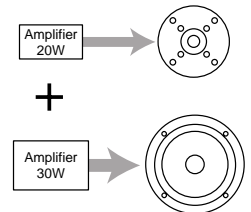

#### ● Digital Input

In addition to XLR and TRS phone analog input, the DS-50A is provided with digital input connectors (coaxial and optical) that support 96 kHz sample rate and 24-bit digital audio.

Digitally input signals are reproduced faithfully through 24-bit D/A conversion, thus preventing noise or a drop in sound quality.

You can use the monitors with a wide variety of equipment and applications through selective use of the analog and digital settings.



#### ● Reproduction of a Variety of Speaker Sounds (combination with the VS or VM)

By connecting the Roland V-Studio (VS series) or V-Mixer (VM series) to the DS-50A and using Speaker Modeling Function of VS or VM, the DS-50A can reproduce the sounds from a wide range of speakers, ranging from the professional monitors from other manufacturers to the speaker in a small household television set.

You can use the DS-50A in combination with the V-Studio or V-Mixer to simulate the sound checks at mixdown, which conventionally have required switching between multiple pairs of monitors set up to compare the sound.

*\* Please be aware that not all VS/VM series units are capable of providing speaker modeling. Before making your purchase, you should confirm that the unit you are considering does indeed provide the features you desire.*



 <b>CAUTION</b> RISK OF ELECTRIC SHOCK DO NOT OPEN	
<b>ATTENTION:</b> RISQUE DE CHOC ELECTRIQUE NE PAS OUVRIR	
<b>CAUTION:</b> TO REDUCE THE RISK OF ELECTRIC SHOCK, DO NOT REMOVE COVER (OR BACK). NO USER-SERVICEABLE PARTS INSIDE. REFER SERVICING TO QUALIFIED SERVICE PERSONNEL.	



The lightning flash with arrowhead symbol, within an equilateral triangle, is intended to alert the user to the presence of uninsulated "dangerous voltage" within the product's enclosure that may be of sufficient magnitude to constitute a risk of electric shock to persons.



The exclamation point within an equilateral triangle is intended to alert the user to the presence of important operating and maintenance (servicing) instructions in the literature accompanying the product.

INSTRUCTIONS PERTAINING TO A RISK OF FIRE, ELECTRIC SHOCK, OR INJURY TO PERSONS.

## IMPORTANT SAFETY INSTRUCTIONS SAVE THESE INSTRUCTIONS

**WARNING** - When using electric products, basic precautions should always be followed, including the following:

1. Read these instructions.
2. Keep these instructions.
3. Heed all warnings.
4. Follow all instructions.
5. Do not use this apparatus near water.
6. Clean only with a damp cloth.
7. Do not block any of the ventilation openings. Install in accordance with the manufacturers instructions.
8. Do not install near any heat sources such as radiators, heat registers, stoves, or other apparatus (including amplifiers) that produce heat.
9. Do not defeat the safety purpose of the polarized or grounding-type plug. A polarized plug has two blades with one wider than the other. A grounding type plug has two blades and a third grounding prong. The wide blade or the third prong are provided for your safety. When the provided plug does not fit into your outlet, consult an electrician for replacement of the obsolete outlet.
10. Protect the power cord from being walked on or pinched particularly at plugs, convenience receptacles, and the point where they exit from the apparatus.
11. Only use attachments/accessories specified by the manufacturer.
12. Never use with a cart, stand, tripod, bracket, or table except as specified by the manufacturer, or sold with the apparatus. When a cart is used, use caution when moving the cart/apparatus combination to avoid injury from tip-over.
13. Unplug this apparatus during lightning storms or when unused for long periods of time.
14. Refer all servicing to qualified service personnel. Servicing is required when the apparatus has been damaged in any way, such as power-supply cord or plug is damaged, liquid has been spilled or objects have fallen into the apparatus, the apparatus has been exposed to rain or moisture, does not operate normally, or has been dropped.



**For the U.K.**

**WARNING:** THIS APPARATUS MUST BE EARTHED  
**IMPORTANT:** THE WIRES IN THIS MAINS LEAD ARE COLOURED IN ACCORDANCE WITH THE FOLLOWING CODE.  
 GREEN-AND-YELLOW: EARTH, BLUE: NEUTRAL, BROWN: LIVE

As the colours of the wires in the mains lead of this apparatus may not correspond with the coloured markings identifying the terminals in your plug, proceed as follows:

The wire which is coloured GREEN-AND-YELLOW must be connected to the terminal in the plug which is marked by the letter E or by the safety earth symbol  or coloured GREEN or GREEN-AND-YELLOW.



The wire which is coloured BLUE must be connected to the terminal which is marked with the letter N or coloured BLACK.

The wire which is coloured BROWN must be connected to the terminal which is marked with the letter L or coloured RED.







# USING THE UNIT SAFELY

## INSTRUCTIONS FOR THE PREVENTION OF FIRE, ELECTRIC SHOCK, OR INJURY TO PERSONS

### About WARNING and CAUTION Notices







 <b>WARNING</b>	Used for instructions intended to alert the user to the risk of death or severe injury should the unit be used improperly.
 <b>CAUTION</b>	Used for instructions intended to alert the user to the risk of injury or material damage should the unit be used improperly. * Material damage refers to damage or other adverse effects caused with respect to the home and all its furnishings, as well to domestic animals or pets.

### About the Symbols







	The  symbol alerts the user to important instructions or warnings. The specific meaning of the symbol is determined by the design contained within the triangle. In the case of the symbol at left, it is used for general cautions, warnings, or alerts to danger.
	The  symbol alerts the user to items that must never be carried out (are forbidden). The specific thing that must not be done is indicated by the design contained within the circle. In the case of the symbol at left, it means that the unit must never be disassembled.
	The  symbol alerts the user to things that must be carried out. The specific thing that must be done is indicated by the design contained within the circle. In the case of the symbol at left, it means that the power-cord plug must be unplugged from the outlet.

## ALWAYS OBSERVE THE FOLLOWING



### WARNING

- Before using this unit, make sure to read the instructions below, and the Owner's Manual. 
- Do not open or perform any internal modifications on the unit. 
- Do not attempt to repair the unit, or replace parts within it (except when this manual provides specific instructions directing you to do so). Refer all servicing to your retailer, the nearest Roland Service Center, or an authorized Roland distributor, as listed on the "Information" page. 
- Never use or store the unit in places that are:
  - Subject to temperature extremes (e.g., direct sunlight in an enclosed vehicle, near a heating duct, on top of heat-generating equipment); or are 
  - Damp (e.g., baths, washrooms, on wet floors); or are 
  - Humid; or are
  - Exposed to rain; or are
  - Dusty; or are
  - Subject to high levels of vibration.
- Make sure you always have the unit placed so it is level and sure to remain stable. Never place it on stands that could wobble, or on inclined surfaces. 
- The unit should be connected to a power supply only of the type described in the operating instructions, or as marked on the unit. 



### WARNING

- Do not excessively twist or bend the power cord, nor place heavy objects on it. Doing so can damage the cord, producing severed elements and short circuits. Damaged cords are fire and shock hazards! 
- This unit, either alone or in combination with an amplifier and headphones or speakers, may be capable of producing sound levels that could cause permanent hearing loss. Do not operate for a long period of time at a high volume level, or at a level that is uncomfortable. If you experience any hearing loss or ringing in the ears, you should immediately stop using the unit, and consult an audiologist. 
- Do not allow any objects (e.g., flammable material, coins, pins); or liquids of any kind (water, soft drinks, etc.) to penetrate the unit.   

- In households with small children, an adult should provide supervision until the child is capable of following all the rules essential for the safe operation of the unit. 
- Protect the unit from strong impact. (Do not drop it!) 







**⚠ WARNING**

- Do not force the unit's power-supply cord to share an outlet with an unreasonable number of other devices. Be especially careful when using extension cords—the total power used by all devices you have connected to the extension cord's outlet must never exceed the power rating (watts/amperes) for the extension cord. Excessive loads can cause the insulation on the cord to heat up and eventually melt through. 
- Before using the unit in a foreign country, consult with your retailer, the nearest Roland Service Center, or an authorized Roland distributor, as listed on the "Information" page. 

**⚠ CAUTION**

- The unit should be located so that its location or position does not interfere with its proper ventilation. 
- Always grasp only the plug on the power-supply cord when plugging into, or unplugging from, an outlet or this unit. 
- Try to prevent cords and cables from becoming entangled. Also, all cords and cables should be placed so they are out of the reach of children. 

**⚠ CAUTION**

- Never climb on top of, nor place heavy objects on the unit. 
- Never handle the power cord or its plugs with wet hands when plugging into, or unplugging from, an outlet or this unit. 
- Before moving the unit, disconnect the power plug from the outlet, and pull out all cords from external devices. 
- Before cleaning the unit, turn off the power and unplug the power cord from the outlet (Maintenance p. 5). 
- Whenever you suspect the possibility of lightning in your area, pull the plug on the power cord out of the outlet. 
- Should you remove the optical connector caps, make sure to put them in a safe place out of children's reach, so there is no chance of them being swallowed accidentally. 

# Contents

**USING THE UNIT SAFELY ..... 3**

**IMPORTANT NOTES ..... 5**

**Names of Things and What They Do ..... 6**

**Connection Examples ..... 8**

    Important Notes on Placement ..... 8

    Precautions When Connecting and Turning on the Power ..... 8

    Using Two DS-50A Monitors for Stereo Sound..... 8

    Using As a Reference Monitor for the V-Studio or V-Mixer ..... 9

**Reference ..... 10**

    Troubleshooting ..... 10

    Specifications ..... 10

    Dimensions ..... 10

    Frequency Response ..... 11

# IMPORTANT NOTES

In addition to the items listed under “IMPORTANT SAFETY INSTRUCTIONS” and “USING THE UNIT SAFELY” on pages 2 and 3, please read and observe the following:

## Power Supply

- Do not use this unit on the same power circuit with any device that will generate line noise (such as an electric motor or variable lighting system).
- Before connecting this unit to other devices, turn off the power to all units. This will help prevent malfunctions and/or damage to speakers or other devices.

## Placement

- This device may interfere with radio and television reception. Do not use this device in the vicinity of such receivers.
- Do not expose the unit to direct sunlight, place it near devices that radiate heat, leave it inside an enclosed vehicle, or otherwise subject it to temperature extremes. Also, do not allow lighting devices that normally are used while their light source is very close to the unit (such as a piano light), or powerful spotlights to shine upon the same area of the unit for extended periods of time. Excessive heat can deform or discolor the unit.
- To avoid possible breakdown, do not use the unit in a wet area, such as an area exposed to rain or other moisture.
- Do not allow rubber, vinyl, or similar materials to remain on the piano for long periods of time. Such objects can discolor or otherwise harmfully affect the finish.
- Do not put anything that contains water (e.g., flower vases) on the piano. Also, avoid the use of insecticides, perfumes, alcohol, nail polish, spray cans, etc., near the unit. Swiftly wipe away any liquid that spills on the unit using a dry, soft cloth.
- Do not paste stickers, decals, or the like to this instrument. Peeling such matter off the instrument may damage the exterior finish.
- During Operation, this device must be placed at a distance of no less than 50 cm from any walls.
- Do not allow objects to remain on top of the unit while it is in operation.
  - If you cover the heat sink, their function is defeated, and their temperature can rise to overly high levels,

which could cause burns if they are accidentally touched.

- Placing heavy objects on this unit may result in injury if it overturns or falls.



Please also refer to “Important Notes on Placement” (p. 8).

## Maintenance

- To clean the unit, use a dry, soft cloth; or one that is slightly dampened. Try to wipe the entire surface using an equal amount of strength. Rubbing too hard in the same area can damage the finish.
- Never use benzine, thinners, alcohol or solvents of any kind, to avoid the possibility of discoloration and/or deformation.

## Additional Precautions

- Use a reasonable amount of care when using the unit’s buttons, sliders, or other controls; and when using its jacks and connectors. Rough handling can lead to malfunctions.
- When connecting / disconnecting all cables, grasp the connector itself—never pull on the cable. This way you will avoid causing shorts, or damage to the cable’s internal elements.
- A small amount of heat will radiate from the unit during normal operation.
- To avoid disturbing your neighbors, try to keep the unit’s volume at reasonable levels (especially when it is late at night).
- When you need to transport the unit, package it in the box (including padding) that it came in, if possible. Otherwise, you will need to use equivalent packaging materials.
- Use a cable from Roland to make the connection. If using some other make of connection cable, please note the following precautions.
  - Some connection cables contain resistors. Do not use cables that incorporate resistors for connecting to this unit. The use of such cables can cause the sound level to be extremely low, or impossible to hear. For information on cable specifications, contact the manufacturer of the cable.

# Names of Things and What They Do

## Front

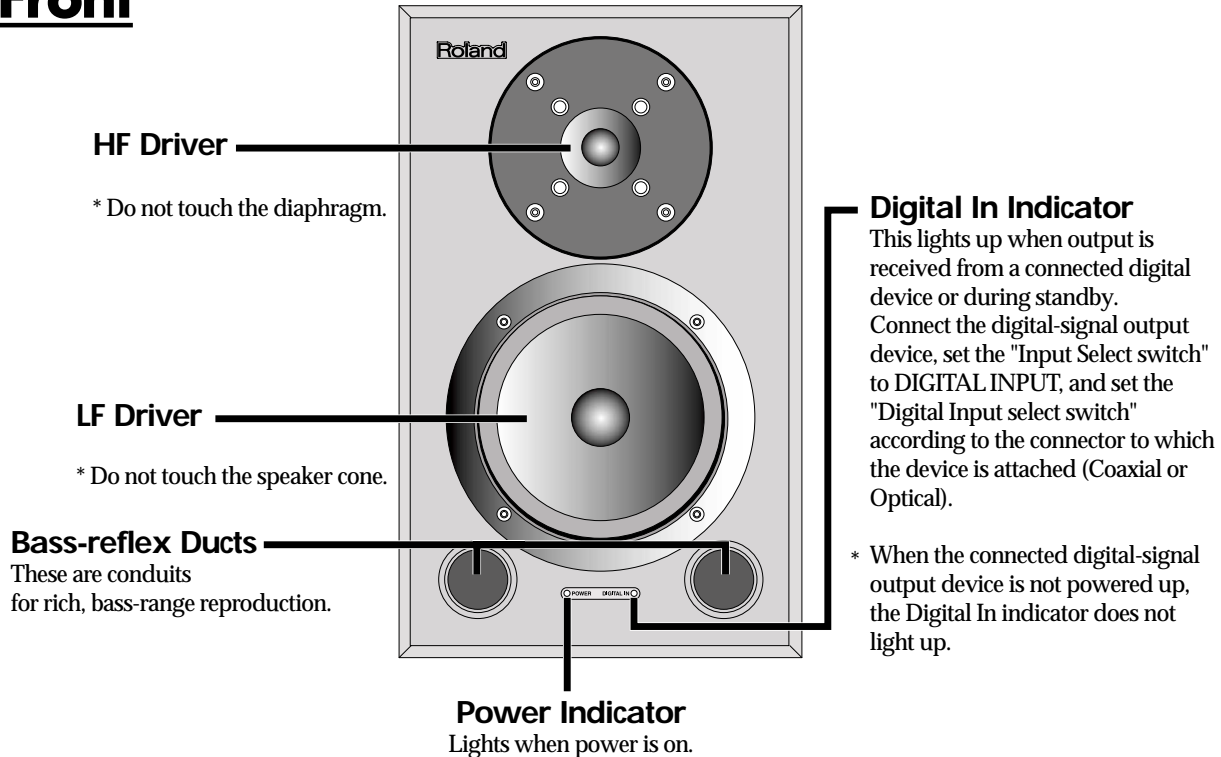

## Rear

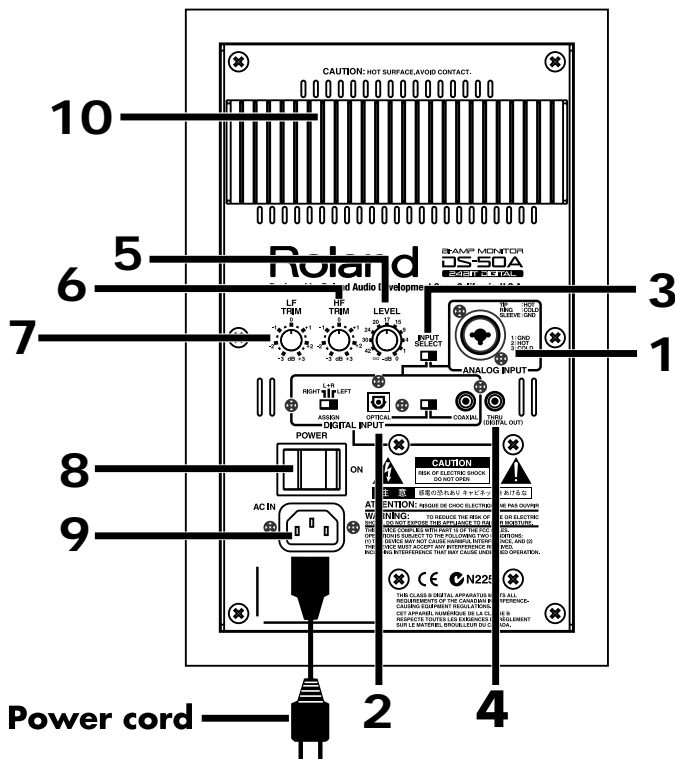

### 1 Analog Input

#### XLR/TRS Phone Input Connector (Analog Input)

This is for connecting XLR or TRS phone plugs.

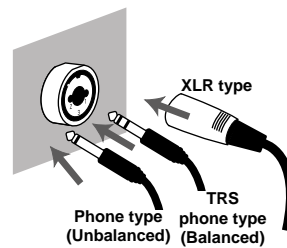

Both balanced and unbalanced connections are possible.

#### NOTE

The pin assignment for the connector is as shown below.

Before making any connections, make sure that this pin assignment is compatible with that of all your other devices.

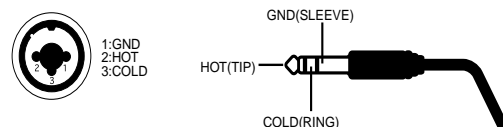

## 2 Digital Input

### Coaxial Input Connector (Digital Input)

This is the digital input connector for coaxial cable.

#### NOTE

*It cannot be used for input of analog audio signals (no sound is produced).*

### Optical Input Connector (Digital Input)

This is the digital input connector for optic-fiber cable.

Use commercially available optical cable for audio equipment to make the connection.

#### NOTE

### Optical-connector Protective Cap

- After removing the protective cap, put in a safe place so that it doesn't get lost.
- When not using the optical connector, attach the cap to keep the connector safe.
- When using the optical connector, be sure that the cap you removed is placed out of the reach of children. If a child has accidentally swallowed a cap, see a doctor immediately.

### Digital Input Select Switch

This switch selects Optical or Coaxial. Select the connector used for the input signal.

### Assign Switch

This switch selects the stereo position of the digital signal.

It selects Right, L+R, or Left when using two DS-50A monitors for stereo sound (with digital signals).

Choose the setting appropriate for your setup.

#### MEMO

With the DS-50A, there is no difference between L and R. When using the digital input connectors of two DS-50A monitors for stereo sound, the digital signal can be input to either L or R.

## 3 Input Select Switch

Used to select Digital Input or Analog Input.

Select the connector used for the input signal.

## 4 Thru (Digital Out) Connector

When connecting multiple DS-50A monitors with digital signals, this connector is used for output to the second DS-50A.



Refer to "Connection Examples" (p. 8, 9).

## 5 Level Control

This adjusts the input level. Turning the control clockwise increases the sound from the speakers.

## 6 HF Trim Control

This adjusts the sound quality of the treble range (10 kHz, +/-3 dB).

## 7 LF Trim Control

This adjusts the sound quality of the bass range (80 Hz, +/-3 dB).

#### MEMO

The LF Trim and HF Trim controls on the DS-50A are designed to correct the sound quality of the sonic field. Use these to make fine adjustments to match the usage conditions.

## 8 Power Switch

This switch turns the power on/off.

#### NOTE

- *Before turning the power on or off, you must lower the volume of this unit and your connected device etc.*
- This unit is equipped with a protection circuit. A brief interval (a few seconds) after power up is required before the unit will operate normally.

## 9 AC Inlet

Connect the included Power cord here. Plug it firmly in, so that the cable does not accidentally become disconnected.

## 10 Heat Sink

This is a heat-radiating plate that dissipates excess heat.

# Connection Examples

## Important Notes on Placement

- During setup and transport, be careful not to damage the vibrating portions (the speaker cone and diaphragm).
- Be sure to place the monitor so that the heat sink on the rear panel is not obstructed. Also, make sure the monitor does not touch any curtains or other fabrics.
- The heat sink performs cooling when the monitor is placed as shown below. Do not place the monitor on its side or upside down.
- When this device is in operation, the heat sink located on the rear panel will become hot. Take care not to touch them with your hands.

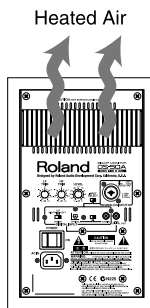

\* Please also refer to "Placement" in IMPORTANT NOTES (p. 5).

## Precautions When Connecting and Turning on the Power

- To prevent malfunction and/or damage to speakers or other devices, always turn down the volume, and turn off the power on all devices before making any connections.
- Once the connections have been completed, turn on power to your various devices in the order specified. By turning on devices in the wrong order, you risk causing malfunction and/or damage to speakers and other devices. (When turning the power off, reverse this procedure.)

Connected devices → DS-50A

- This unit is equipped with a protection circuit. A brief interval (a few seconds) after power up is required before the unit will operate normally.

## Using Two DS-50A Monitors for Stereo Sound

### Example for Using Analog Input Connectors

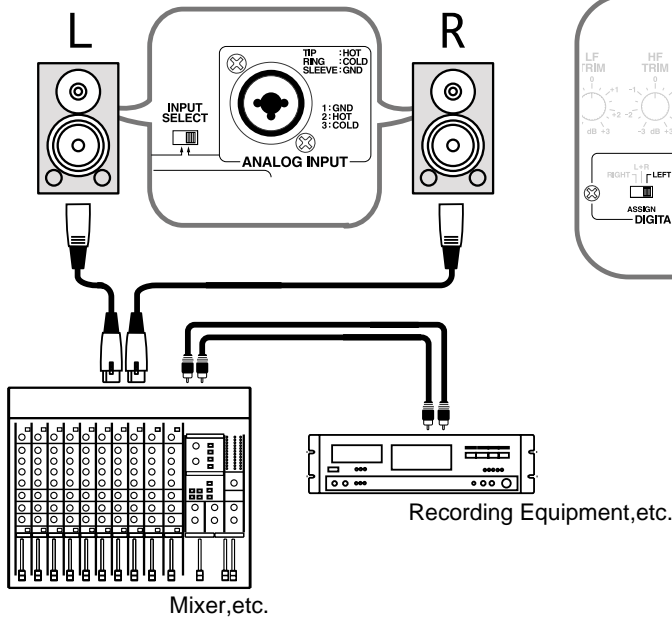

### Example for Using Digital Input Connectors

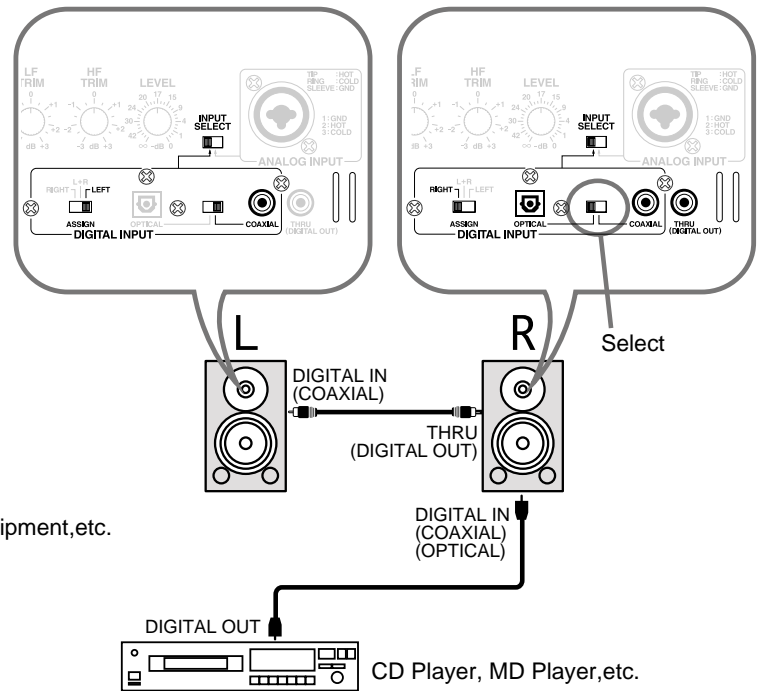



## Using As a Reference Monitor for the V-Studio or V-Mixer

The DS-50A supports the "Speaker Modeling" function that is included in the Roland V-studio (VS series) and V-mixer (VM series).

### NOTE

- Please be aware that not all VS/VM series units are capable of providing speaker modeling. Before making your purchase, you should confirm that the unit you are considering does indeed provide the features you desire.
- Speaker Modeling is not possible using just the DS-50A. Take a look at the documentation for the VS/VM series.



### What's Speaker Modeling?

This feature uses digital signal processing to model the changes in sound quality produced by a particular speaker during audio output. This lets you use one type of monitor speaker to emulate speakers from other manufacturers, and even the speakers from small household-use television sets and other equipment. You can use the DS-50A in combination with this to simulate the sound checks at mixdown, which conventionally have required switching between multiple pairs of monitors set up to compare the sound.

### Connection Example (VS-890)

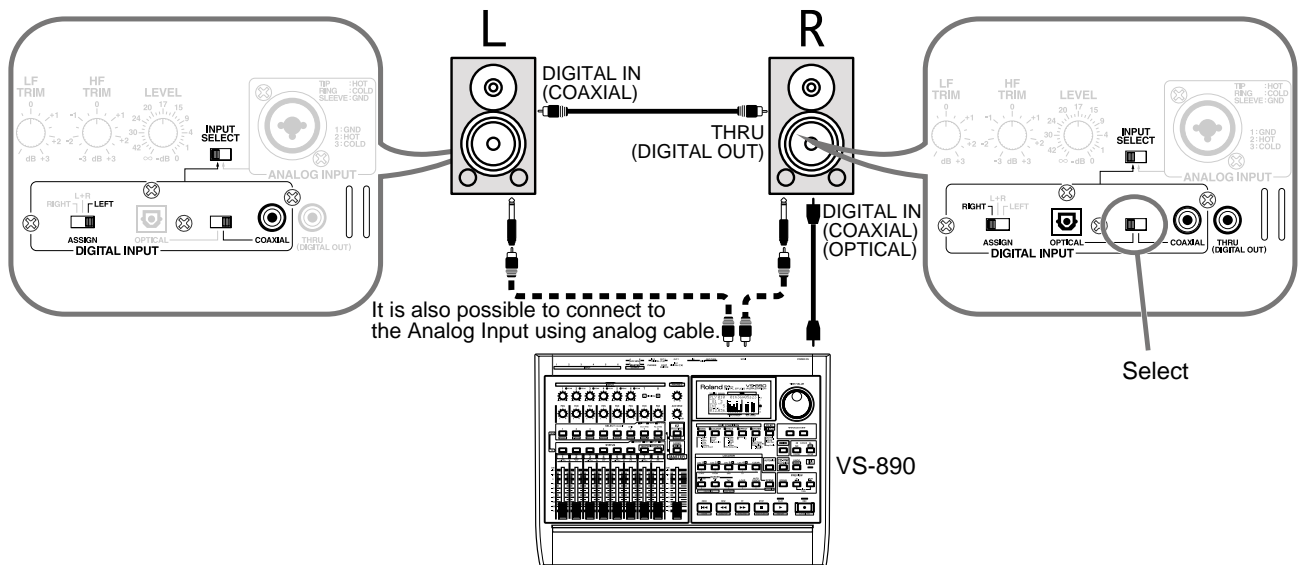

### Tips about high sound quality playback

- Please pay careful attention to the placement location. In order to take full advantage of the low-frequency playback capabilities of this device, we recommend that you place it on a hard and strong base.
- When using digital in connections, turn down the LEVEL knob of this device and raise the output level of the connected device. This will take advantage of the full number of bits in the digital signal, improving the audio quality.

# Reference

## Troubleshooting

If there is no sound or if the unit does not operate as you expect, please check the following points first. If this does not resolve the problem, contact the nearest Roland service center or authorized Roland distributor.

### There's No Sound

- Make sure the Input Level control has not been turned fully counterclockwise.
- Make sure the Input Select switch has been set to the connector where the input signal is connected (Digital Input or Analog Input).
- Make sure the Digital Input select switch has been set to the connector where the input signal is connected (Optical or Coaxial).
- Input a digital signal to the Digital Input connector. No sound is produced when an analog signal is input.

### The volume level of the instrument connected to ANALOG INPUT is too low

- Could you be using a connection cable that contains a resistor? Use a connection cable that does not contain a resistor.

### During Digital Signal Input, the Stereo Image Is Reversed or Sounds Unnatural, or Output Doesn't Sound Like Stereo

- Check the setting of the Assign switch (Right, L+R, or Left). The DS-50A uses an identical construction for the left and right monitors, and makes no distinction between left and right. During digital signal input, set the Assign switch L or R as appropriate for your setup.

## Specifications

### ●System

2 Way Bi-Amplified Monitor

### ●Enclosure

Bass-reflex type

### ●Cabinet

1/2" MDF, Baffle: 3/4" MDF

### ●LF Driver

120 mm (5") Foamed polypropylene cone type, magnetically shielded

### ●HF Driver

19 mm (3/4") soft dome type, magnetically shielded

### ●Frequency Response

68 Hz to 22 kHz (+/-3dB)

### ●Crossover Frequency

2.3 kHz (active third order)

### ●LF Amplifier Power

30 W

### ●HF Amplifier Power

20 W

### ..... Analog in .....

- Input Sensitivity  
0 dBu (0.775 Vrms)

- Input Impedance  
20k ohm (Balanced/Unbalanced)

### ..... Digital in .....

- Format  
Conformity with S/P DIF
- Sample Rate  
32 kHz to 96 kHz (de-emphasis: OFF)
- D/A Converter  
24 bit

### ●Controls

LEVEL Knob

LF TRIM Knob (80 Hz, +/-3dB)

HF TRIM Knob (10 kHz, +/-3dB)

INPUT SELECT SW

(Analog In/Digital In)

ASSIGN SW (Right/L+R/Left)

DIGITAL INPUT SELECT SW

(Optical/Coaxial)

POWER SW

### ●Indicators

POWER

DIGITAL IN

### ●Connectors

ANALOG INPUT(XLR/TRS PHONE,

Balanced/Unbalanced)

DIGITAL INPUT (Optical)

DIGITAL INPUT (Coaxial)

DIGITAL THRU OUT (Coaxial)

### ●Power Supply

AC117 V, AC230 V or AC240 V

### ●Power Consumption

50 W

### ●Dimensions

197 (W) x 267 (D) x 312 (H) mm

7-3/4 (W) x 10-1/2 (D) x 12-1/4 (H)

inches

### ●Weight

8 kg / 17 lbs. 11 oz.

### ●Accessories

Owner's Manual

Power cord

*\* In the interest of product improvement, the specifications and/or appearance of this unit are subject to change without prior notice.*

## Dimensions

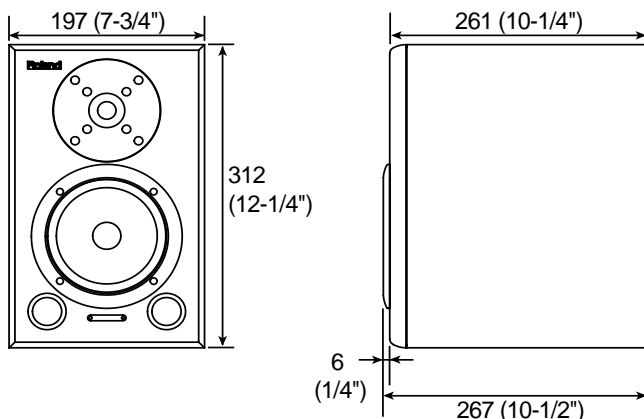

\* Not include the Power cord.

## Frequency Response

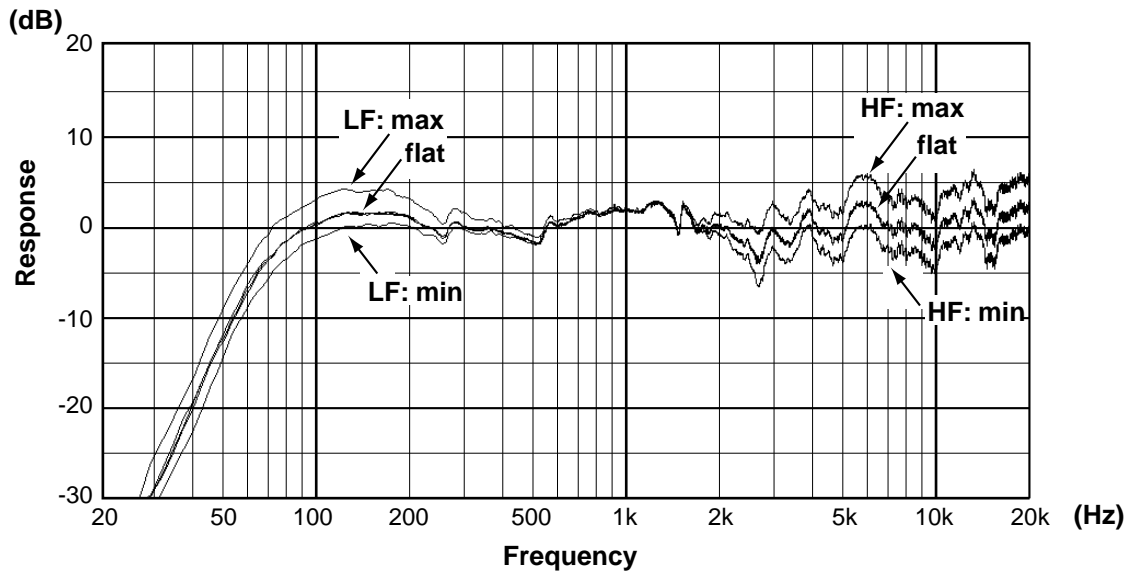

This product complies with the requirements of European Directives EMC 89/336/EEC and LVD 73/23/EEC.

For EU Countries

### FEDERAL COMMUNICATIONS COMMISSION RADIO FREQUENCY INTERFERENCE STATEMENT

This equipment has been tested and found to comply with the limits for a Class B digital device, pursuant to Part 15 of the FCC Rules. These limits are designed to provide reasonable protection against harmful interference in a residential installation. This equipment generates, uses, and can radiate radio frequency energy and, if not installed and used in accordance with the instructions, may cause harmful interference to radio communications. However, there is no guarantee that interference will not occur in a particular installation. If this equipment does cause harmful interference to radio or television reception, which can be determined by turning the equipment off and on, the user is encouraged to try to correct the interference by one or more of the following measures:

- Reorient or relocate the receiving antenna.
- Increase the separation between the equipment and receiver.
- Connect the equipment into an outlet on a circuit different from that to which the receiver is connected.
- Consult the dealer or an experienced radio/TV technician for help.

Unauthorized changes or modification to this system can void the users authority to operate this equipment. This equipment requires shielded interface cables in order to meet FCC class B Limit.

For the USA

### NOTICE

This Class B digital apparatus meets all requirements of the Canadian Interference-Causing Equipment Regulations.

### AVIS

Cet appareil numérique de la classe B respecte toutes les exigences du Règlement sur le matériel brouilleur du Canada.

For Canada

# Information

When you need repair service, call your nearest Roland Service Center or authorized Roland distributor in your country as shown below.

## AFRICA

### EGYPT

**Al Fanny Trading Office**  
P.O. Box 2904,  
El Horrieh Heliopolis, Cairo,  
EGYPT  
TEL: (02) 4185531

### REUNION

**Maison FO - YAM Marcel**  
25 Rue Jules Merman, ZL  
Chaudron - BP79 97491  
Ste Clotilde REUNION  
TEL: 28 29 16

### SOUTH AFRICA

**That Other Music Shop  
(PTY) Ltd.**  
11 Melle Street (Cnr Melle and  
Juta Street)  
Braamfontein, 2001,  
Republic of SOUTH AFRICA  
TEL: (011) 403 4105

**Paul Bothner (PTY) Ltd.**  
17 Werdmuller Centre Claremont  
7700  
Republic of SOUTH AFRICA

P.O. Box 23032  
Claremont, Cape Town  
SOUTH AFRICA, 7735  
TEL: (021) 64 4030

## ASIA

### CHINA

**Beijing Xinghai Musical  
Instruments Co., Ltd.**  
6 Huangmchang Chao Yang  
District, Beijing, CHINA  
TEL: (010) 6774 7491

### HONG KONG

**Tom Lee Music Co., Ltd.  
Service Division**  
22-32 Pun Shan Street, Tsuen  
Wan, New Territories,  
HONG KONG  
TEL: 2415 0911

### INDIA

**Rivera Digitec (India) Pvt. Ltd.**  
409, Nirman Kendra Mahalaxmi  
Flats Compound Off. Dr. Edwin  
Moses Road, Mumbai-400011,  
INDIA  
TEL: (022) 498 3079

### INDONESIA

**PT Citra IntiRama**  
Jl. Cideng Timur No. 151-150  
Jakarta Pusat  
INDONESIA  
TEL: (021) 6324170

### KOREA

**Cosmos Corporation**  
1461-9, Seocho-Dong,  
Seocho Ku, Seoul, KOREA  
TEL: (02) 3486-8855

### MALAYSIA

**Bentley Music SDN BHD**  
140 & 142, Jalan Bukit Bintang  
55100 Kuala Lumpur, MALAYSIA  
TEL: (03) 2443333

### PHILIPPINES

**G.A. Yupangco & Co. Inc.**  
339 Gil J. Puyat Avenue  
Makati, Metro Manila 1200,  
PHILIPPINES  
TEL: (02) 899 9801

### SINGAPORE

**Sweet Lee Company**  
150 Sims Drive,  
SINGAPORE 387381  
TEL: 748-1669

### CRISTOFORI MUSIC PTE LTD

Blk 3014, Bedok Industrial Park E,  
#02-2148, SINGAPORE 489980  
TEL: 243 9555

### TAIWAN

**ROLAND TAIWAN  
ENTERPRISE CO., LTD.**  
Room 5, 9F, No. 112 Chung Shan  
N. Road Sec.2, Taipei, TAIWAN,  
R.O.C.  
TEL: (02) 2561 3339

### THAILAND

**Theera Music Co., Ltd.**  
330 Vergm NakornKasem, Soi 2,  
Bangkok 10100, THAILAND  
TEL: (02) 2248821

### VIETNAM

**Saigon Music**  
138 Tran Quang Khai St.,  
District 1  
Ho Chi Minh City  
VIETNAM  
TEL: (08) 844-4068

## AUSTRALIA/ NEW ZEALAND

### AUSTRALIA

**Roland Corporation  
Australia Pty., Ltd.**  
38 Campbell Avenue  
Dee Why West. NSW 2099  
AUSTRALIA  
TEL: (02) 9982 8266

### NEW ZEALAND

**Roland Corporation (NZ) Ltd.**  
97 Mt. Eden Road, Mt. Eden,  
Auckland 3, NEW ZEALAND  
TEL: (09) 3098 715

## CENTRAL/LATIN AMERICA

### ARGENTINA

**Instrumentos Musicales S.A.**  
Florida 656 2nd Floor  
Office Number 206A  
Buenos Aires  
ARGENTINA, CP1005  
TEL: (54-11) 4- 393-6057

### BRAZIL

**Roland Brasil Ltda.**  
R. Coronel Octaviano da Silveira  
203 05522-010  
Sao Paulo BRAZIL  
TEL: (011) 3743 9377

### COSTA RICA

**JUAN BANSBACH  
Instrumentos Musicales**  
Ave. I. Calle 11, Apartado 10237,  
San Jose, COSTA RICA  
TEL: (506)258-0211

### CHILE

**Comercial Fancy S.A.**  
Avenida Rancagua #0330  
Providencia Santiago, CHILE  
TEL: 56-2-373-9100

### EL SALVADOR

**OMNI MUSIC**  
75 Avenida Notre YY Alameda,  
Juan Pablo 2, No. 4010  
San Salvador, EL SALVADOR  
TEL: (503) 262-0788

### MEXICO

**Casa Veerkamp, s.a. de c.v.**  
Av. Toluca No. 323, Col. Olivar  
de los Padres 01780 Mexico D.F.  
MEXICO  
TEL: (525) 668 04 80

### La Casa Wagner de

**Guadalajara s.a. de c.v.**  
Av. Corona No. 202 S.J.  
Guadalajara, Jalisco Mexico  
C.P.44100 MEXICO  
TEL: (3) 613 1414

### PANAMA

**SUPRO MUNDIAL, S.A.**  
Boulevard Andrews, Albrook,  
Panama City,  
REP. DE PANAMA  
TEL: (507) 315-0101

### PARAGUAY

**Distribuidora De  
Instrumentos Musicales**  
J.E. Olear y ESQ. Manduvira  
Edeficio, El Dorado Planta Baja  
Asuncion PARAGUAY  
TEL: 595-21-492147

### PERU

**VIDEO Broadcast S.A.**  
Portinari 199 (ESQ. HALS),  
San Borja, Lima 41,  
REP. OF PERU  
TEL: 51-14-758226

### URUGUAY

**Todo Musica S.A.**  
Cuareim 1844, Montevideo,  
URUGUAY  
TEL: 5982-924-2335

### VENEZUELA

**Musicland Digital C.A.**  
Av. Francisco de Miranda,  
Centro Parque de Cristal, Nivel  
C2 Local 20 Caracas  
VENEZUELA  
TEL: (02) 285 9218

## EUROPE

### AUSTRIA

**Roland Austria GES.M.B.H.**  
Siemensstrasse 4, P.O. Box 74,  
A-6063 RUM, AUSTRIA  
TEL: (0512) 26 44 260

### BELGIUM/HOLLAND/ LUXEMBOURG

**Roland Benelux N. V.**  
Houtstraat 3, B-2260, Oevel  
(Westerlo) BELGIUM  
TEL: (014) 575811

### DENMARK

**Roland Scandinavia A/S**  
Nordhavnsvej 7, Postbox 880,  
DK-2100 Copenhagen  
DENMARK  
TEL: (039)16 6200

### FRANCE

**Roland France SA**  
4, Rue Paul Henri SPAAK,  
Parc de l'Esplanade, F 77 462 St.  
Thibault, Lagny Cedex FRANCE  
TEL: 01 600 73 500

### FINLAND

**Roland Scandinavia As,  
Filial Finland**  
Lauttasareentie 54 B  
Fin-00201 Helsinki, FINLAND  
TEL: (9) 682 4020

### GERMANY

**Roland Elektronische  
Musikinstrumente HmbH.**  
Oststrasse 96, 22844 Norderstedt,  
GERMANY  
TEL: (040) 52 60090

### GREECE

**STOLLAS S.A.  
Music Sound Light**  
155, New National Road  
26422 Patras, GREECE  
TEL: 061-435400

### HUNGARY

**Intermusica Ltd.**  
Warehouse Area 'DEPO' PE.83  
H-2046 Torokbalint, HUNGARY  
TEL: (23) 511011

### IRELAND

**Roland Ireland**  
Audio House, Belmont Court,  
Donnybrook, Dublin 4,  
Republic of IRELAND  
TEL: (01) 2603501

### ITALY

**Roland Italy S. p. A.**  
Viale delle Industrie 8,  
20020 Arese, Milano, ITALY  
TEL: (02) 937-78300

### NORWAY

**Roland Scandinavia Avd.  
Kontor Norge**  
Lilleakerveien 2 Postboks 95  
Lilleaker N-0216 Oslo  
NORWAY  
TEL: 273 0074

### POLAND

**P. P. H. Brzostowicz**  
UL. Gibraltarska 4,  
PL-03664 Warszawa POLAND  
TEL: (022) 679 44 19

### PORTUGAL

**Tecnologias Musica e Audio,  
Roland Portugal, S.A.**  
RUA DE SANTA CARARINA  
131/133, 4000-450 PORTO  
PORTUGAL  
TEL: (022) 208 4456

### ROMANIA

**FBS LINES**  
Plata Libertatii 1,  
RO-4200 Cheorgheni  
TEL: (066) 164-609

### RUSSIA

**Slami Music Company**  
Sadogava-Triumfalnaja st., 16  
103006 Moscow, RUSSIA  
TEL: 095 209 2193

### SPAIN

**Roland Electronics  
de España, S. A.**  
Calle Bolivia 239, 08020  
Barcelona, SPAIN  
TEL: (93) 308 1000

### SWEDEN

**Roland Scandinavia A/S  
SWEDISH SALES OFFICE**  
Danvik Center 28, 2 tr.  
S-131 30 Nacka SWEDEN  
TEL: (08) 702 0020

### SWITZERLAND

**Roland (Switzerland) AG  
Musitronic AG**  
Gerberstrasse 5, CH-4410 Liestal,  
SWITZERLAND  
TEL: (061) 921 1615

### UKRAINE

**TIC-TAC**  
Mira Str. 19/108  
P.O. Box 180  
295400 Munkachevo, UKRAINE  
TEL: (03131) 414-40

### UNITED KINGDOM

**Roland (U.K.) Ltd.**  
Atlantic Close, Swansea  
Enterprise Park, SWANSEA  
SA7 9FJ,  
UNITED KINGDOM  
TEL: (01792) 700139

## MIDDLE EAST

### BAHRAIN

**Moon Stores**  
Bab Al Bahrain Road,  
P.O. Box 20077  
State of BAHRAIN  
TEL: 211 005

### CYPRUS

**Radex Sound Equipment Ltd.**  
17 Diagorou St., P.O. Box 2046,  
Nicosia CYPRUS  
TEL: (02) 453 426

### ISRAEL

**Halilit P. Greenspoon &  
Sons Ltd.**  
8 Retzif Fa'aliya Hashnya St.  
Tel-Aviv-Yaho ISRAEL  
TEL: (03) 6823666

### JORDAN

**AMMAN Trading Agency**  
Prince Mohammed St. P.O. Box  
825 Amman 11118 JORDAN  
TEL: (06) 4641200

### KUWAIT

**Easa Husain Al-Yousifi**  
Abdullah Salem Street,  
Safat KUWAIT  
TEL: 5719499

### LEBANON

**A. Chahine & Fils**  
P.O. Box 16-5857 Gergi Zeidan St.  
Chahine Building, Achrafieh  
Beirut, LEBANON  
TEL: (01) 335799

### QATAR

**Badie Studio & Stores**  
P.O. Box 62,  
DOHA QATAR  
TEL: 423554

### SAUDI ARABIA

**aDawlah Universal  
Electronics APL**  
P.O. Box 2154 ALKHOBAR 31952,  
SAUDI ARABIA  
TEL: (03) 898 2081

### SYRIA

**Technical Light & Sound  
Center**  
Khaled Ibn Al Walid St.  
P.O. Box 13520  
Damascus - SYRIA  
TEL: (011) 2235 384

### TURKEY

**Barkat muzik aletleri ithalat  
ve ihracat Ltd Sti**  
Siraselvililer cad.Guney is hani 84-  
86/6, Taksim, Istanbul, TURKEY  
TEL: (0212) 2499324

### U. A. E.

**Zak Electronics & Musical  
Instruments Co. L.L.C.**  
Zabeel Road, Al Sherooq Bldg.,  
No. 14, Grand Floor DUBAI  
U.A.E.  
TEL: (04) 3360715

## NORTH AMERICA

### CANADA

**Roland Canada Music Ltd.  
(Head Office)**  
5480 Parkwood Way Richmond  
B. C., V6V 2M4 CANADA  
TEL: (0604) 270 6626

### Roland Canada Music Ltd. (Toronto Office)

Unit 2, 109 Woodbine Downs  
Blvd, Etobicoke, ON  
M9W 6Y1 CANADA  
TEL: (0416) 213 9707

### U. S. A.

**Roland Corporation U.S.**  
5100 S. Eastern Avenue  
Los Angeles, CA 90040-2938,  
U. S. A.  
TEL: (323) 890 3700