

GIGA DELAY

DD-20

DIGITAL DELAY

Owner's Manual

Thank you, and congratulations on your choice of BOSS DD-20 Digital Delay.

Before using this unit, carefully read the sections entitled: "USING THE UNIT SAFELY" and "IMPORTANT NOTES" (separate sheet).

These sections provide important information concerning the proper operation of the unit. Additionally, in order to feel assured that you have gained a good grasp of every feature provided by your new unit, this manual should be read in its entirety. The manual should be saved and kept on hand as a convenient reference.

Main Features

- A full 23-second long delay provides plenty of time for loop play and sound-on-sound.
- The Memory function allows you to store up to four tones in the DD-20 itself, independent of the panel settings. You also get "seamless switching," with memories switched smoothly as the reverberation continues.
- Features a Delay mode with a total of eleven effects, including new "SMOOTH," "TWIST" and some effects modeled on analog and tape echo effects.
- The new "Time Advance function" provides quick, yet sensitive control of delay times.
- Equipped with custom backlit LCD for clear, easy viewing of delay times, even on dark stages.

Copyright © 2003 BOSS CORPORATION

All rights reserved. No part of this publication may be reproduced in any form without the written permission of BOSS CORPORATION.

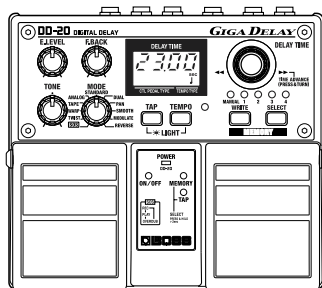

 **BOSS**®

Contents

Main Features	1	How to Use Each Mode.....	21
Installing Batteries.....	3	How to Use SOS (Sound On Sound).....	21
Making the Connections	4	How to Use TWIST.....	22
Mono Connection.....	5	How to Use WARP.....	22
Stereo Connection	5	How to Use TAPE.....	23
Connecting the Stereo Output and the		How to Use DUAL	24
Effects Processor.....	6	How to Use MODULATE.....	25
Connecting to SEND/RETURN	6	How to Use the Tempo	
With Guitar and Bass Amps.....	6	Function	26
Connecting to an MTR or Mixer....	7	Indicating the BPM in the	
Operation	8	Delay Time Display	27
ON/OFF Pedal Operation.....	8	Settings Made When the	
Panel Operation.....	9	Power is Switched ON	28
Storing Settings (Write Operation).....	10	Global Procedures	28
Storing the “MANUAL” Sound in		Changing the Pedal Mode Settings.....	29
Memory	10	Setting the Output Mode.....	30
Changing and Storing the		Setting the External Pedal Function....	31
“MEMORY” Sound	12	Changing How Memory Numbers Are	
MEMORY/TAP Pedal Operation		Indicated	33
(Switching Memories)	14	Returning Settings to Their Factory	
MEMORY/TAP Pedal Operation		Defaults	34
(Tap Input)	15	Troubleshooting.....	35
Part Names and Functions 16		Sample Settings	37
Front Panel.....	16	Setting Memo.....	40
Operating the DELAY TIME Knob..	17	Specifications.....	41
MODE List	18	Index.....	42
Rear Panel	20		

Installing Batteries

Batteries are supplied with the unit. The life of these batteries may be limited, however, since their primary purpose was to enable testing.

Insert the included batteries as shown in figure, being careful to orient the batteries correctly.

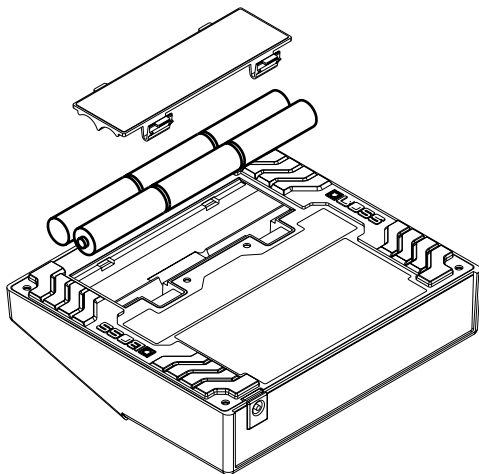

NOTE

- When turning the unit upside-down, get a bunch of newspapers or magazines, and place them under the four corners or at both ends to prevent damage to the buttons and controls. Also, you should try to orient the unit so no buttons or controls get damaged.
- When turning the unit upside-down, handle with care to avoid dropping it, or allowing it to fall or tip over.
- Make sure the “+” and “-” ends of the batteries are oriented correctly.
- When the batteries run down, the POWER indicator gets dim. If this happens, replace with new batteries.
- When replacing the batteries, use six AA type.
- Avoid using new batteries together with used ones. In addition, avoid mixing different types of batteries. Doing so can result in fluid leakage.
- Battery life can vary depending on battery type.

MEMO

Continuous usage time under battery power is about 7 hours with alkaline batteries and about 2 hours with carbon batteries. (This may vary according to usage conditions.)

Making the Connections



- The use of an AC adaptor is recommended as the unit's power consumption is relatively high. Should you prefer to use batteries, please use the alkaline type.
- Noise may be produced if wireless communications devices, such as cell phones, are operated in the vicinity of this unit. Such noise could occur when receiving or initiating a call, or while conversing. Should you experience such problems, you should relocate such wireless devices so they are at a greater distance from this unit, or switch them off.
- Use a cable from Roland to make the connection. If using some other make of connection cable, please note the following precautions.
 - Some connection cables contain resistors. Do not use cables that incorporate resistors for connecting to this unit. The use of such cables can cause the sound level to be extremely low, or impossible to hear. For information on cable specifications, contact the manufacturer of the cable.
- When the unit is running on battery power, the power comes on when you insert the connector plug into the INPUT A (MONO) jack.
- To prevent malfunction and/or damage to speakers or other devices, always turn down the volume, and turn off the power on all devices before making any connections.
- If there are batteries in the unit while an AC adaptor is being used, normal operation will continue should the line voltage be interrupted (power blackout or power cord disconnection).
- Once the connections have been completed, turn on power to your various devices in the order specified. By turning on devices in the wrong order, you risk causing malfunction and/or damage to speakers and other devices.

When powering up: Turn on the power to your guitar amp **last**.

When powering down: Turn off the power to your guitar amp **first**.
- Always make sure to have the volume level turned down before switching on power. Even with the volume all the way down, you may still hear some sound when the power is switched on, but this is normal, and does not indicate a malfunction.
- When operating on battery power only, the unit's indicator and backlit LCD will become dim when battery power gets too low. Replace the battery as soon as possible.
- When moved from one location to another where the temperature and/or humidity is very different, water droplets (condensation) may form inside the unit. Damage or malfunction may result if you attempt to use the unit in this condition. Therefore, before using the unit, you must allow it to stand for several hours, until the condensation has completely evaporated.

Mono Connection

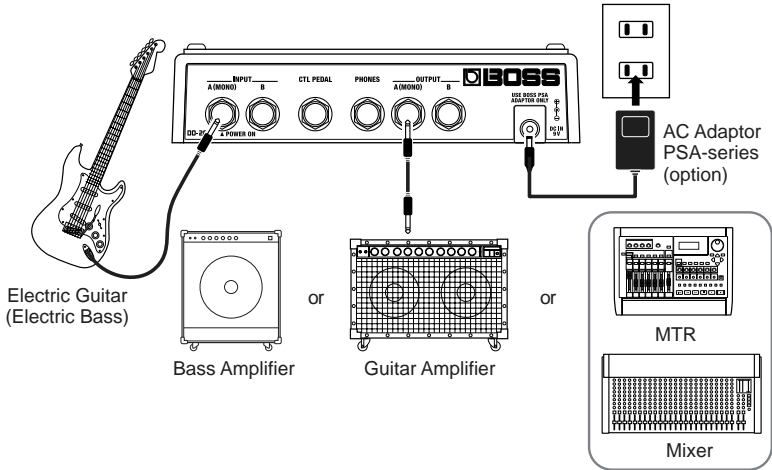

Stereo Connection

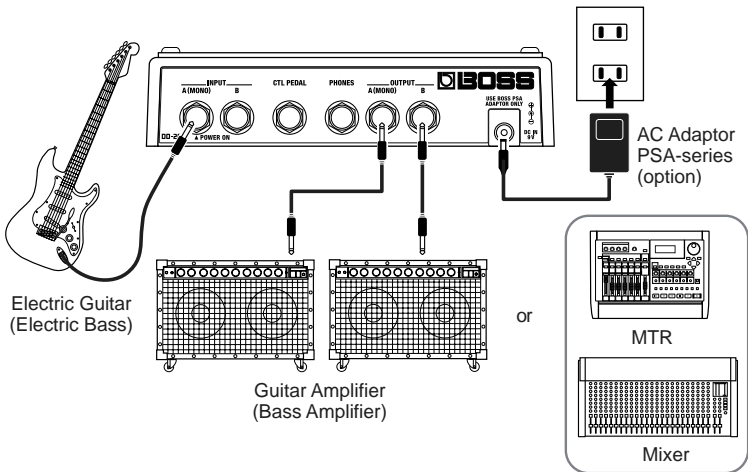

Connecting the Stereo Output and the Effects Processor

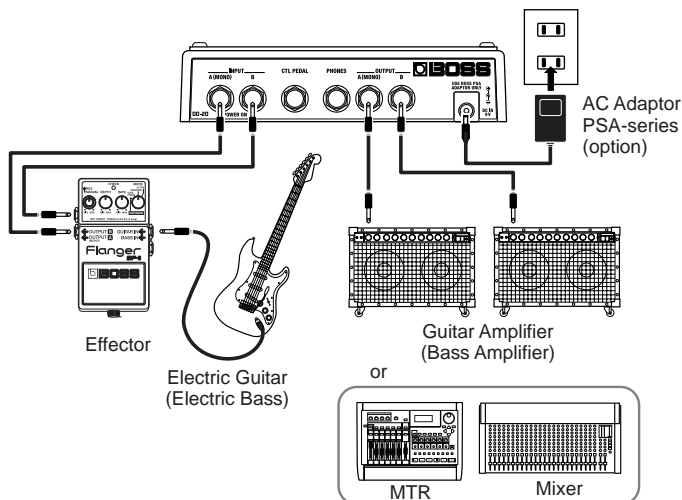

Connecting to SEND/RETURN

With Guitar and Bass Amps

- * Match the DD-20's level setting and the output level from the guitar or bass amp's SEND output. If there is any distortion in the sound, reduce the level on the connected device.
- * If the guitar or bass amp's SEND/RETURN level is +4 dBu, switch the setting to "+4 dB" as described in "Setting the Output Mode" (p. 30).

Mono Send/Mono Return

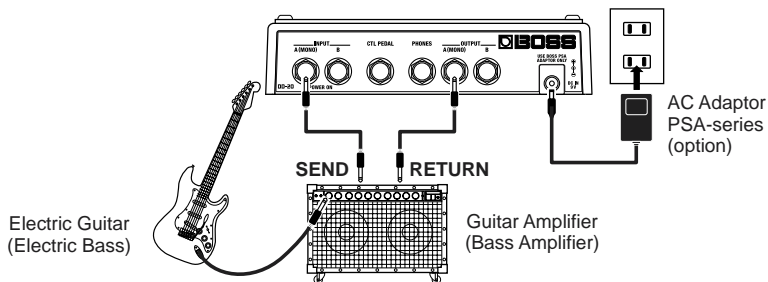

Mono Send/Stereo Return

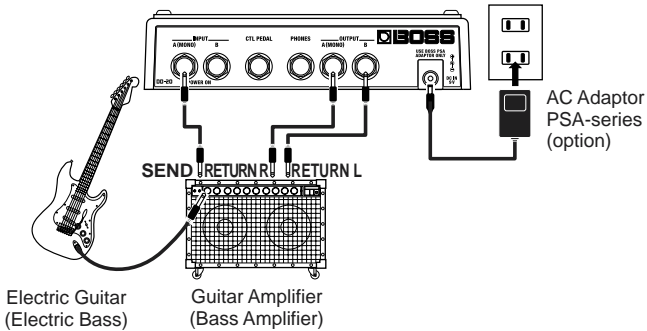

Connecting to an MTR or Mixer

Mono Send/Mono Return

When using the DD-20 while connected to the SEND/RETURN of a mixer or multitrack recorder, follow the instructions in “Setting the Output Mode” (p. 30) to set “A: Direct Sound + B: Effect Sound” so that only the delay signal is output from the DD-20; the sound is output from the OUTPUT B jack.

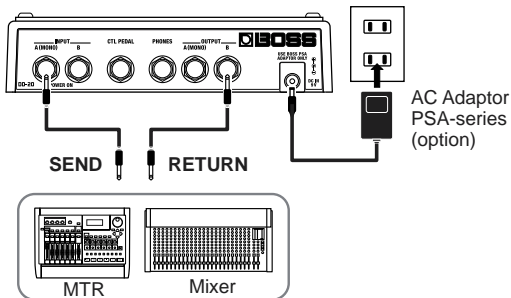

Operation

“Effect On” for the pedal setting and “MANUAL” is selected when the power is turned on.

ON/OFF Pedal Operation

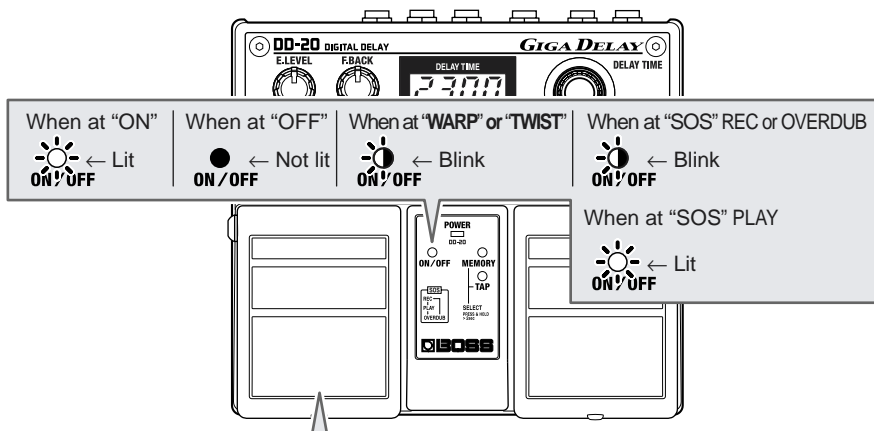

Each press of the ON/OFF pedal switches effects on or off. When effects are off, the sound coming in through the INPUT jack is output unchanged.

- * If the output is set to "A:DIR B:EFX," nothing is output from the OUTPUT B jack when the effects are off. Only the effect sound is output from the OUTPUT B jack when the effects are on. This is set at the factory to "A:DIR B:EFX."

"Setting the Output Mode" (p. 30)

- * The pedal functions differently according to the Pedal mode settings.

"How to Use Each Mode" (p. 21)

- * The DD-20 features a "seamless switching function" whereby the reverberation sound decays gradually, even after the effects are switched off.

Panel Operation

In order to follow along with the instructions given here, you should start out by having effects switched ON (press the ON/OFF pedal and confirm that the ON/OFF indicator has lighted), and press the SELECT button to switch MANUAL (MANUAL indicator has lighted in green).

Also set the knobs as shown in the illustration.

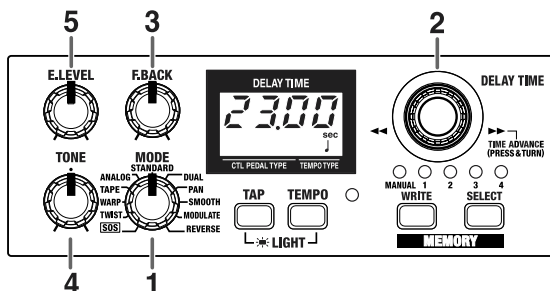

1. Rotate the **MODE** knob to select an appropriate delay effect from the eleven available types.

2. Adjust the delay time by rotating the **DELAY TIME** knob.

* Pressing the knob down as you turn it cause the delay time to change more rapidly. Furthermore, the rate at which it changes also varies according to how the knob is turned. More detail, refer to "Operating the DELAY TIME Knob" (p. 17).

3. Rotate the **F. BACK** knob to adjust the amount of the feedback.

4. Adjust the tone of the effect sound with the **TONE** knobs.

The frequency response is flat when the knob is at the center position. You can usually leave the knob at the center position.

5. Adjust the volume of the effect sound with the **E.LEVEL** knob.

Saving the Current Delay Time as the "Manual" Setting

If you press the DELAY TIME knob after adjusting the delay time, the current delay time is then stored to the DD-20 as the "Manual" setting.

This setting is preserved even while the power is turned off, and is selected as the default delay time setting (display) when the power is turned on again.

Storing Settings (Write Operation)

Storing the “MANUAL” Sound in Memory

NOTE Do not switch off the power while a write operation is in progress.

* You cannot carry out the Write operation when the MODE knob is turned to “SOS.”

1. Create the sound you want using knobs.

2. Press the WRITE button.

The MEMORY indicator and the indicator for the currently selected memory flash, and the DD-20 is put into write standby.

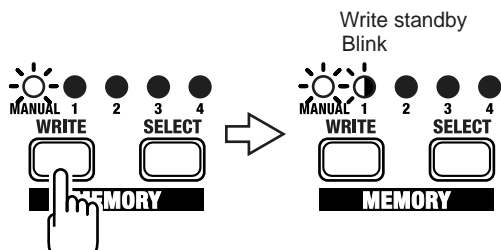

3. Press the SELECT button to select the memory (number) to which you want to store the sound.

The indicator for the selected memory number flashes.

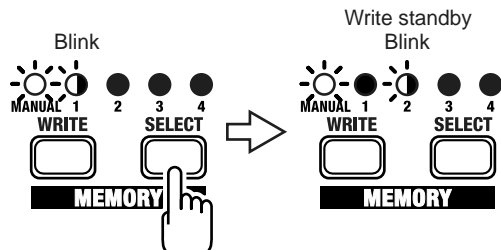

4. Press the WRITE button.

The write operation is completed when the indicator for the write-destination memory begin to flash more rapidly.

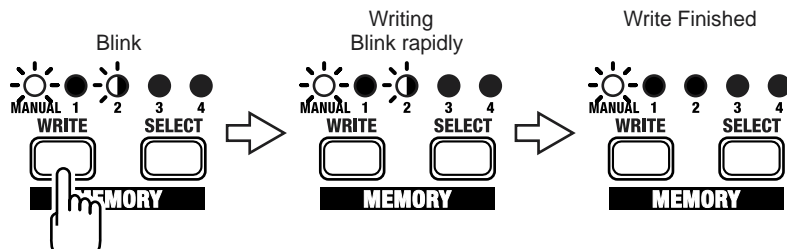

* To cancel the write operation, then before you press the WRITE button, rotate the knob or operate the MANUAL/TAP pedal.



Please be aware that all data contained in the unit's memory may be lost when the unit is sent for repairs. Important data should always be written down on paper, "Setting Memo" (p. 40). During repairs, due care is taken to avoid the loss of data. However, in certain cases (such as when circuitry related to memory itself is out of order), we regret that it may not be possible to restore the data, and Roland assumes no liability concerning such loss of data.



Please be aware that the contents of memory can be irretrievably lost as a result of a malfunction, or the improper operation of the unit. To protect yourself against the risk of losing important data, we recommend that you write down important data you have stored in the unit's memory on "Setting Memo" (p. 40).



Unfortunately, it may be impossible to restore the contents of data that was stored in the unit's memory once it has been lost. Roland Corporation assumes no liability concerning such loss of data.

Changing and Storing the “MEMORY” Sound

NOTE Do not switch off the power while a write operation is in progress.

1. Press the **MANUAL/TAP** pedal or the **SELECT** button to change to the “MEMORY” sound.

2. Operate the knobs to change the sound.

* To avoid sudden inadvertent changes in sound, the *E.LEVEL*, *TONE*, and *F. BACK* knobs are designed so that the setting does not change unless the knob is first turned as far as the stored setting value. Once the position of the knob matches the setting value stored in memory, the sound starts to change.

When a setting changes, the *MEMORY* indicator flashes automatically.

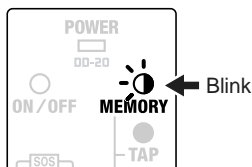

3. Press the **WRITE** button.

The *MEMORY* indicator and the indicator for the currently selected memory number start to flash, and the DD-20 is put into write standby.

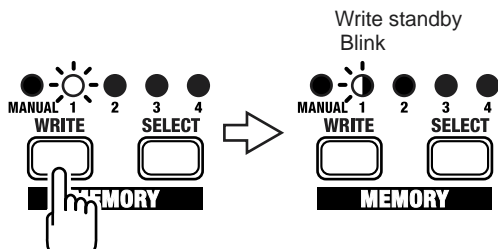

4. Press the SELECT button to select the memory (number) to which you want to store the sound.

The indicator for the selected memory number flashes.

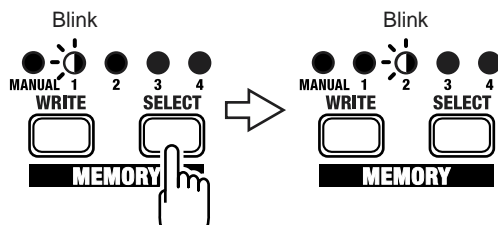

5. Press the WRITE button.

The write operation is completed when the indicator for the write-destination memory begin to flash more rapidly.

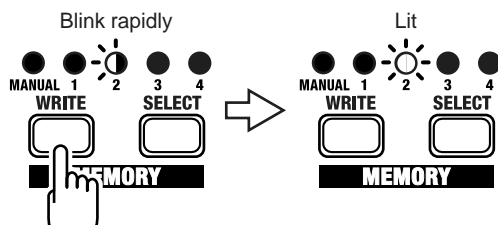

* If the knob or the MANUAL/TAP pedal position is changed before the WRITE button is pressed, the write operation is cancelled, and the DD-20 is returned to the status in effect in Step 2.

MEMORY/TAP Pedal Operation (Switching Memories)

The Pedal mode (1–3) changes the function of the pedals. Use the most appropriate setting for your particular application.

- * *The following operations are performed while the MEMORY indicator is lit.*
- * *The DD-20 features a “seamless switching function.”*
When you switch memories using this function, the reverberation from the memory prior to switching continues to sound, for more natural-sounding transitions.
- * *At the factory settings, Pedal mode is set to “1.”*
When changing the Pedal mode settings, refer to p. “Changing the Pedal Mode Settings” (p. 29).

Pedal mode: 1

Pressing the MEMORY/TAP pedal cycles you through a series of selections, in this order: MANUAL → MEMORY 1 → MEMORY 2 → MEMORY 3 → MEMORY 4 → MANUAL. This convenient feature makes it easier to switch memories in which multiple memories are used.

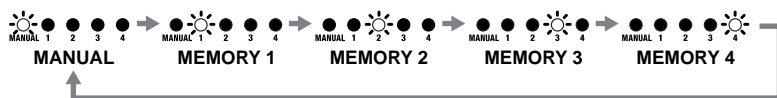

Pedal mode: 2

Pressing the MEMORY/TAP pedal switches you between MANUAL and the selected memory (shown by the lit indicator). This is a convenient way to toggle between two sound settings.



Pedal mode: 3

Pressing the MEMORY/TAP pedal toggles you between MANUAL and the selected memory (shown by the lit indicator).



You can also select among Memories 1–4 by pressing the MEMORY/TAP pedal and ON/OFF pedal simultaneously. This is convenient when you want to use your foot to rapidly switch memories to call up a desired sound.

* *You cannot carry out this operation when the MODE knob is turned to “SOS.”*

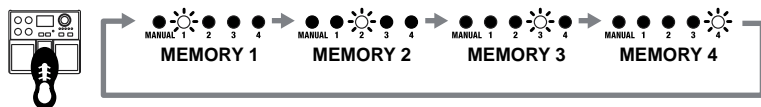

MEMORY/TAP Pedal Operation (Tap Input)

When the MODE knob is turned to any setting besides “SOS,” then pressing and holding down the pedal for at least two seconds causes the TAP indicator to light up and switches the MEMORY/TAP pedal function to Tap Input.

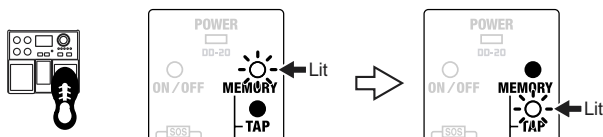

You can easily set the delay time to match the tempo of the song being played by pressing the pedal in time with the song’s tempo (Tap Input).

The TEMPO indicator flashes in time with the tempo being input with Tap Input.

* *You can use the TEMPO button to change the delay time set with Tap Input. Refer to “How to Use the Tempo Function” (p. 26).*

Part Names and Functions

Front Panel

F.BACK (feedback) Knob

Adjusts the feedback level (or how much the sound is repeated).

* Oscillation may occur with certain input sounds, or when the knob is set at certain positions.

* This knob is not functional when "SOS" is selected as the mode (p. 18).

E.LEVEL (effect level) Knob

Adjusts the volume of the effect sound.

TONE Knob

This adjusts the tone of the effect's sound.

The frequency response is flat when the knob is set to the center position; turning it to the right boosts the higher frequencies, and turning it to the left cuts the higher frequencies.

* This knob is not functional when "SOS" is selected as the mode (p. 18).

MODE Knob

Select the type of delay effect (p. 18).

TAP Button

The delay time is set according to the intervals between taps of the button. You can switch between the delay time indicator and the BPM indicator by holding down the button for two seconds or longer.

DELAY TIME Knob

This sets the delay time for the sound.

You can turn the knob without pushing it (changing the delay time in 1-msec units) or while pushing it (activating the Time Advance function).



"Operating the DELAY TIME Knob" (p. 17)

MEMORY Number Indicators (1-4)

The indicator for the currently selected MEMORY number (1-4) lights.

The indicator flashes while the DD-20 is in write standby; the indicator flashes more rapidly while the write operation is in progress.

SELECT Button

This changes MANUAL or memories 1-4.

WRITE Button

Press this to store settings in "MEMORY."

TEMPO Button

This is used to specify the length of the delay time for the tempo input with Tap Input in terms of the note length.

* You can turn the display backlighting on and off by together pressing both the TAP button and the TEMPO button.

TEMPO Indicator

This flashes in time with the beat for the selected tempo.

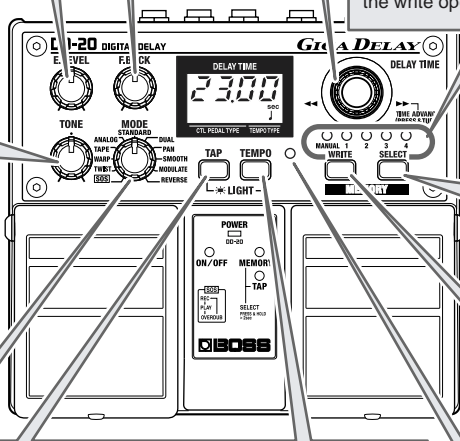

Operating the DELAY TIME Knob

When adjusting the delay time with the DELAY TIME knob, the setting normally changes in units of one millisecond (or ten milliseconds if the time is ten seconds or longer). However, simultaneously pressing and turning the knob causes the delay time setting to change rapidly, allowing you to quickly reach the value you want, even with higher values. This feature is called the “Time Advance function.”



The settings range for Delay Time is from one millisecond to 23 seconds. When the BPM is indicated (p. 27), the settings range is from 3 to 9999.

* The range of the setting varies according to the mode and tempo selected.

Normal Operation

- Turning this knob to the right increases the delay time in units of one millisecond (one click).
- Turning this knob to the left decreases the delay time in units of one millisecond (one click).

Operating the Time Advance Function

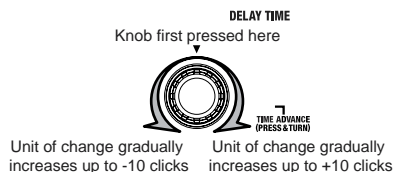

- When you hold down the knob and turn it to the right, the delay time starts increasing. The rate of change increases the more the knob is turned.
- When you hold down the knob and turn it to the left, the delay time starts decreasing. The rate of change increases the more the knob is turned.

MODE List

SOS (Sound On Sound)	In this mode, you can record up to 23 seconds of material and repeatedly play back the phrases from the material. What's more, you can record new phrases and add them to the previous material (overdub) as many times as you like. → "How to Use SOS (Sound On Sound)" (p. 21)
TWIST	This is a new type of delay that produces an aggressive, spinning sensation. Using this with distortion creates an even wilder twist. → "How to Use TWIST" (p. 22)
WARP	This simultaneously controls the delay sound's feedback level and volume to produce a totally unreal delay. → "How to Use WARP" (p. 22)
TAPE	This tone is modeled on the Roland "RE-201" Tape Echo. You can adjust the settings to change the number of "heads." <i>* The delay time can be set in a range from 120 milliseconds to 23 seconds.</i> → "How to Use TAPE" (p. 23)
ANALOG	This tone is modeled on the BOSS "DM-2" Compact Delay.
STANDARD	This is normal delay.
DUAL	This is a delay with short and long delays connected in series. → "How to Use DUAL" (p. 24)
PAN	This is a panning delay, with the delay sound output alternately from the left and right sides (OUTPUT A/B).
SMOOTH	This delay spreads out spatially, producing a more natural reverberation effect.
MODULATE	This delay adds a pleasant wavering effect to the sound. → "How to Use MODULATE" (p. 25)
REVERSE	This creates a reverse playback effect. You can adjust the E.LEVEL knob setting to get two different kinds of effect, "Direct Sound + Effect Sound" and "Effect Sound Only." Turning the E.LEVEL knob completely to the right switches this to "Effect Sound Only." <i>* The delay time can be set in a range from 10 milliseconds to 23 seconds.</i>

** You can choose how the sound is output from the OUTPUT jacks in "Setting the Output Mode" (p. 30); select either "STEREO OUTPUT" or "A: Direct Sound, B: Effect Sound."*

**DUAL Indicator
(SHORT, LONG)**

Indicates the delay time as well as the delay (SHORT, LONG) when the DD-20 is set to DUAL mode.

**Output Mode Indicator
(A:EFX, B:DIR, +4dB)**

☞ "Setting the Output Mode" (p. 30)

**Control Pedal Function Indicator
(ON/OFF, TAP, MEM)**

☞ "Setting the External Pedal Function" (p. 31)

Display

When the power is turned on, the backlighting comes on, then goes off again after approximately twenty seconds. This feature is intended to prevent unnecessary battery drainage. If you want to keep the backlighting on, simultaneously press the TAP button and TEMPO button; the light then stays on.

- * Remember to check on battery power consumption.
- * Never strike or apply strong pressure to the display.

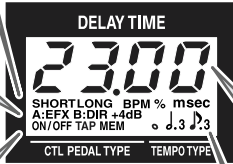

DELAY TIME

This shows the unit of time for the currently selected delay time (or BPM unit).

When MODE is set to SOS, it indicates the remaining memory (%) during recording and the loop phrase position during playback and overdubbing.

**Tempo Type Indicator
(♩ ♪ ♫)**

☞ "How to Use the Tempo Function" (p. 26)

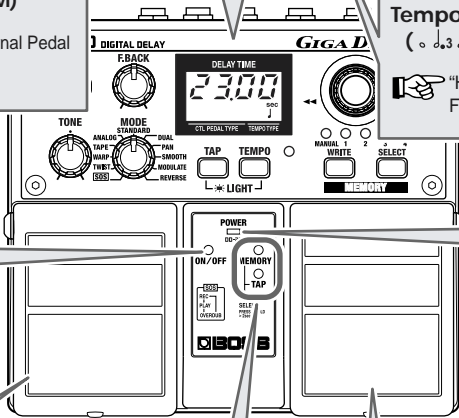

ON/OFF Indicator

This lights up when effects are on.

POWER Indicator

This lights up when the power is on.

ON/OFF Pedal

Each press of the pedal switches the effects on or off.

With MODE set to WARP or TWIST, pressing on the pedal produces the corresponding effect.

MEMORY Indicator

This is lit when the MEMORY/TAP pedal is used for switching between MANUAL and memories (1-4).

TAP Indicator

This is lit when the MEMORY/TAP pedal is used for Tap Input.

MEMORY/TAP Pedal

This pedal performs two functions, as a "Memory Pedal" used for switching between MANUAL and memories (1-4), and for "Tap Input" of the delay time.

☞ "MEMORY/TAP Pedal Operation" (p. 14, 15)

Rear Panel

INPUT Jacks (A (MONO), B)

This is the input jack for connecting to the output of an electric guitar or other instrument or effects processor. For MONO use, make the connection to the A (MONO) jack.

 "Making the Connections" (p. 4)

* The INPUT A (MONO) jack also doubles as the power switch when the unit is running on battery power. The power comes on when a plug is inserted into the INPUT A (MONO) jack, and goes off when it is unplugged. Unplug any connected cords when the unit is not in use.

PHONES Jack

You can connect headphones here to monitor the sound.

- * Turn on the power before you connect headphones. When turning off the power, first unplug the headphones, then switch off the power.
- * Please observe due caution when using headphones while the Output Mode is set to +4 dB, since their volume may get significantly higher.

AC Adaptor Jack

This jack is for connecting an AC adaptor (BOSS PSA-series, sold separately). Using an AC adaptor makes possible long performances with no worry about batteries going dead.

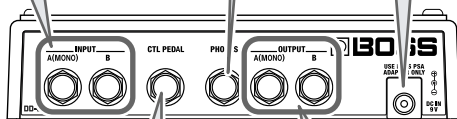

CTL PEDAL Jack

Connect an external control pedal (the optional BOSS FS-5L/FS-5U) to this jack.

You can use the external control pedal to turn the effect on and off, to input the delay time with Tap Input, and to switch memories.

 "Setting the External Pedal Function" (p. 31)

OUTPUT Jacks (A (MONO), B)

This jack is for connection to a guitar/bass amp, another effects processor, mixer, MTR, or the like. For MONO use, make the connection to the A (MONO) jack.

 "Making the Connections" (p. 4)

How to Use Each Mode

How to Use SOS (Sound On Sound)

1. Turn the MODE knob to "SOS."
2. Press the ON/OFF pedal to start recording.

Play what is to be used as the basic phrase.

The remaining memory is indicated as a percentage in the display.

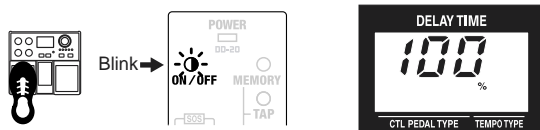

3. Press the ON/OFF pedal again to stop recording.

Loop playback of the recorded phrase begins at the same time you press the pedal.

The loop time is indicated in the display as shown below.

The TEMPO indicator also flashes.

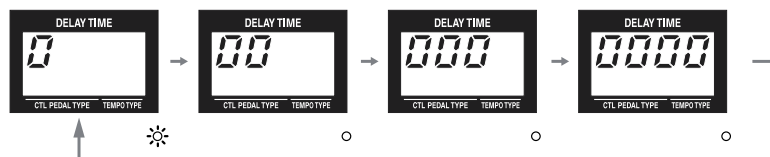

4. Overdub another phrase.

Sounds are overdubbed during loop playback only while the pedal is held down.

Continue to hold the pedal down as you play the phrase you want to record.

- * If the ON/OFF pedal is held down only for a brief period, loop playback stops, and the recorded phrase is erased.



By pressing the MEMORY/TAP pedal during loop playback, you can have the delay applied to the guitar sound as loop playback continues. However, you cannot overdub. To stop loop playback, press the MEMORY/TAP button again (we recommend Pedal Mode 2 or 3).

How to Use TWIST

1. Turn the **MODE** knob to “TWIST.”

2. Hold down the **ON/OFF** pedal.

The delay sound starts to oscillate, then the oscillation speeds up as its pitch increases.

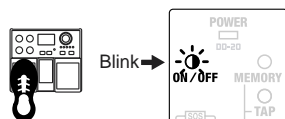

3. Release the pedal.

The oscillating sound begins to fade away, and the normal delay sound returns.

This effect works very well with distortion sounds, and combining it with distortion results in an even wilder effect (you can adjust the volume of the oscillating sound with the E.LEVEL knob). Using this for the ending of a song is effective.

* You can switch the normal effect on and off by pressing the ON/OFF pedal only briefly.

How to Use WARP

1. Turn the **MODE** knob to “WARP.”

2. Hold down the **ON/OFF** pedal.

The feedback level and volume increase.

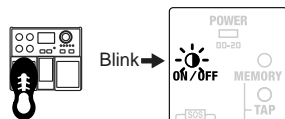

3. Release the pedal.

The effect corresponding to the knob positions (E.LEVEL, F.BACK) resumes.

You can create fantastic effects by repeating the “warped” delay sound and then playing a phrase on top of this.

* You can switch the normal effect on and off by pressing the ON/OFF pedal only briefly.

How to Use TAPE

You can have either one or two “playback heads” used for the tape echo effect. Setting this to “2” produces a multi-tap delay effect.

1. Turn the **MODE** knob to “TAPE.”
2. Hold down the **ON/OFF** pedal until “HEd1” or “HEd2” appears in the display.
3. You can change the number of playback heads used by continuing to hold down the **ON/OFF** pedal as you turn the **DELAY TIME** knob.

HEd1: One head is used

HEd2: Two heads are used



* This is set at the factory to “HEd1.”

* This setting is preserved even after the power is turned off. If you want to save it as a setting for the Memories (1–4), then carry out the Write procedure (p. 10).

How to Use DUAL

Although DUAL mode features a short delay and long delay connected in series, you can change the delay time for the short delay.

1. Turn the **MODE knob** to “DUAL.”
2. Hold down the **ON/OFF pedal** until “SHORT” appears in the display. In this case, the short delay’s delay time is indicated.



3. You can change the delay time by continuing to hold down the **ON/OFF pedal** as you turn the **DELAY TIME knob**.

* This is set at the factory to “SHORT 50msec, LONG 300 msec.”

* This setting is preserved even after the power is turned off. If you want to save it as a setting for the Memories (1–4), then carry out the Write procedure (p. 10).

How to Use MODULATE

You can change the MODULATE modulation rate and depth settings.

1. Turn the **MODE** knob to “MODULATE.”
2. Hold down the **ON/OFF** pedal until “r” appears in the display.

The rate value appears next to the “r” in the display.



3. You can change the rate value by continuing to hold down the **ON/OFF** pedal as you turn the **DELAY TIME** knob.
4. Hold down the **ON/OFF** pedal and turn the **DELAY TIME** knob to have “d” displayed.

The depth value appears next to the “d” in the display.

* Press the **DELAY TIME** knob once more to have “r” displayed.

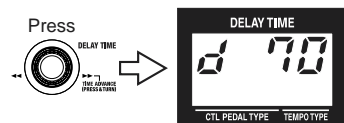

5. You can change the depth by continuing to hold down the **ON/OFF** pedal as you turn the **DELAY TIME** knob.

* This is set at the factory to “r:80, d:70.”

* This setting is preserved even after the power is turned off. If you want to save it as a setting for the Memories (1–4), then carry out the Write procedure (p. 10).

How to Use the Tempo Function

The DD-20 includes a “Tempo function,” which allows you to specify the delay time in terms of note lengths.

The display is switched as shown below each time you press the TEMPO button.

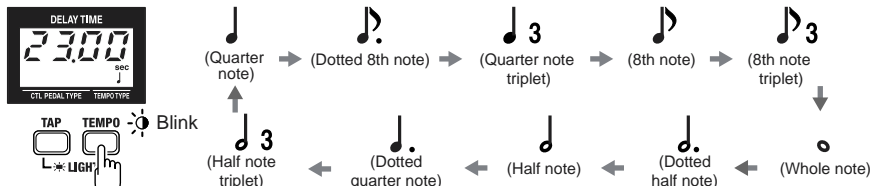

- * Notes for certain delay time settings may not be indicated in the display.
- * The range of the delay time setting differs according to the tempo selected.

The delay sound produced is as shown in the figure.

Rhythm Used in Pressing the TAP Pedal or the TAP Button

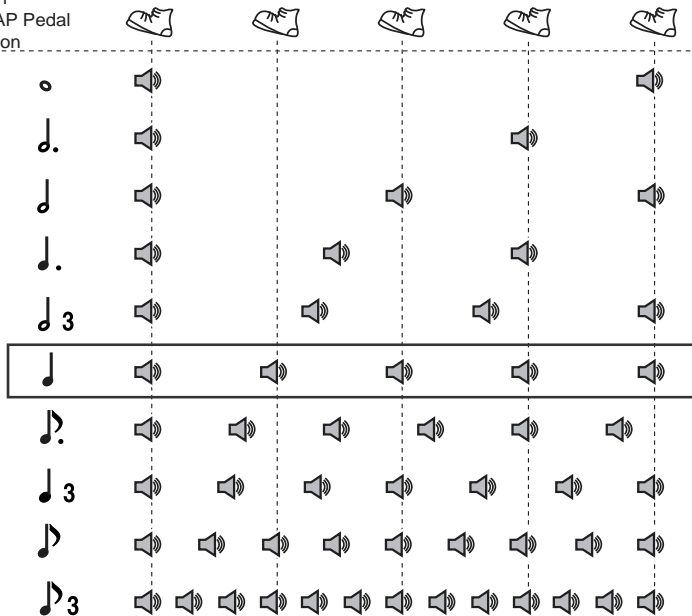

- * If you want to set the delay time to match the timing of the tap input, select “Quarter Note.”

Indicating the BPM in the Delay Time Display

You can switch the DD-20's time delay display to show the tempo (BPM).

If, for example, you already know the BPM of the song you are performing, you can get a perfectly synchronized delay effect by setting the delay time with the indicated tempo (BPM).

* *Specifying the note lengths with the TEMPO button also makes it easy to specify the times for dotted notes, triplets, and other kinds of notes.*

1. Hold down the TAP button until the delay time indicated in the display changes to show the tempo (BPM).

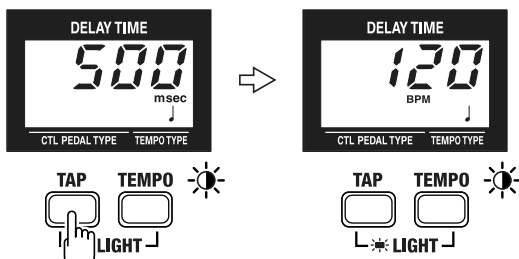

Use this same procedure to return to the time (msec) display.

When the delay time is saved after switching the display, the method used to display it is also saved.

Settings Made When the Power is Switched ON

You can make the following settings with the operations performed while turning on the power.

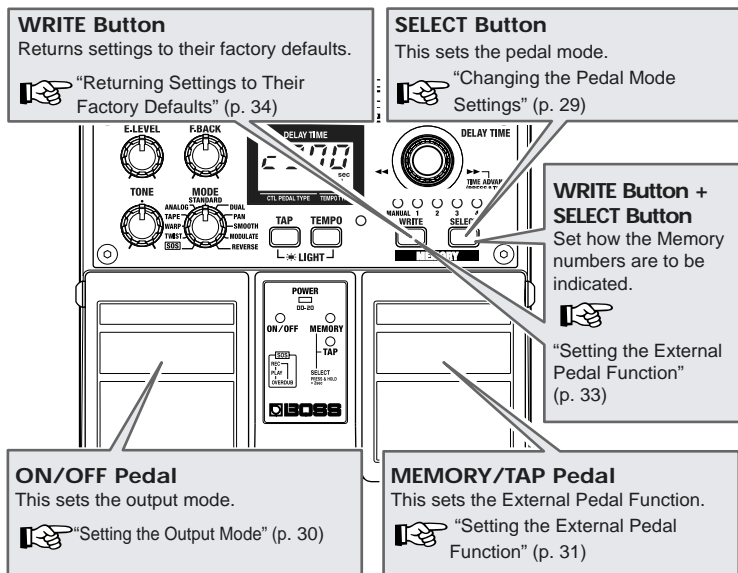

Global Procedures

Switch off the power.

- **When running on battery power:**
Disconnect the connection plug from the INPUT A (MONO) jack.
- **When running on power from an AC adaptor:**
Disconnect the plug from the INPUT A (MONO) jack and the AC ADAPTOR jack.

Switch on the power.

- **When running on battery power:**
Insert the connection plug into the INPUT A (MONO) jack.
- **When running on power from an AC adaptor:**
Insert the AC ADAPTOR plug into the AC ADAPTOR jack.

Changing the Pedal Mode Settings

Use the following to change the Pedal mode settings.

* Pedal mode settings are saved even after the power is turned off.

1. Switch off the power.

2. While holding down the SELECT button, switch on the power.

The MEMORY 1-3 indicator corresponding to the current Pedal mode settings flashes.
The Pedal mode is indicated in the display.

3. Set the pedal mode (1-3) pressing the SELECT button.

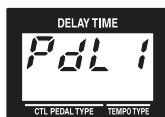

Pedal Mode 1



Pedal Mode 2



Pedal Mode 3

4. Press the WRITE button.

After the MEMORY Number indicator begins flashing rapidly, the setting is stored in memory and the unit returns to its ordinary state.

* To cancel the setting change and return the unit to its ordinary state, then before you press the WRITE button, operate the MEMORY/TAP or ON/OFF pedal.

Pedal Mode	ON/OFF Pedal	MEMORY/TAP Pedal	ON/OFF Pedal + MEMORY/TAP Pedal
1	Effect on/off	Switches MANUAL or MEMORY 1-4	-
2	Effect on/off	Switches MANUAL or MEMORY	-
3	Effect on/off	Switches MANUAL or MEMORY	Selects from MEMORY 1-4

* Only Pedal mode 3 is enabled when the MEMORY/TAP pedal is being used as a Tap Input pedal (when the TAP indicator is lit).

* This is set at the factory to Pedal Mode 1.

Setting the Output Mode

When using the DD-20 while connected to a guitar or bass amp, mixer, or multitrack recorder SEND/RETURN, you can set the output level (+4 dB) and method of output from the OUTPUT jacks (A: Direct Sound/B: Effect Sound) to match the device connected to the DD-20.

1. Switch off the power.
2. While holding down the ON/OFF pedal, switch on the power.

The output mode setting is indicated in the display, and the MEMORY 1–4 indicator corresponding to the current setting flashes.

3. Set the output mode pressing the SELECT button.

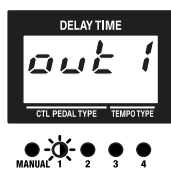

Output Mode 1



Output Mode 2

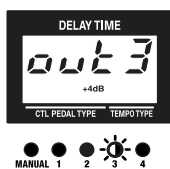

Output Mode 3

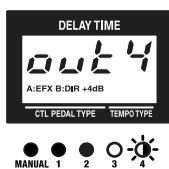

Output Mode 4

4. Press the WRITE button.

After the MEMORY Number indicator begins flashing rapidly, the setting is stored in memory and the unit returns to its ordinary state.

* To cancel the setting change and return the unit to its ordinary state, then before you press the WRITE button, operate the MEMORY/TAP or ON/OFF pedal.

Display	Mode	Output	Level
out1	1	Stereo output	-20 dB
out2, A:DIR / B:EFX	2	A: Direct Sound/B: Effect Sound	-20 dB
out3, +4dB	3	Stereo output	+4 dB
out4, A:DIR / B:EFX, +4dB	4	A: Direct Sound/B: Effect Sound	+4 dB

* Even when this is set to “A: Direct Sound/B: Effect Sound,” if the input is in stereo, then the output will also be in stereo. Additionally, if the input is mono while nothing is connected to the OUTPUT B jack (effect sound), then the sounds are not output as “A: Direct Sound/B: Effect Sound.” If you want to have the output be “A: Direct Sound/B: Effect Sound,” then set the DD-20 so that “A:DIR, B:EFX” appears in the display.

* This is set at the factory to “Output Mode 1.”

Setting the External Pedal Function

You can connect an optional foot switch (the FS-5U or FS-5L) to the CTL PEDAL jack and use the pedal for turning the effects on and off, for tap input, and for switching memories.

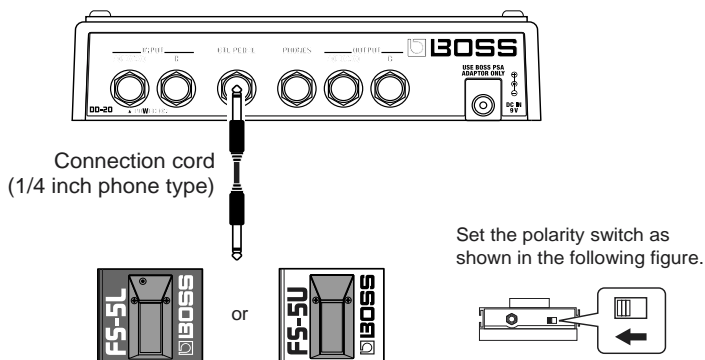

1. **Switch off the power.**
2. **While holding down the MEMORY/TAP pedal, switch on the power.**
The setting is indicated in the display, and the MEMORY 1-3 indicator corresponding to the current setting flashes.
3. **Set the external pedal function pressing the SELECT button.**
Each time you press the SELECT button, it switches through the "ON/OFF," and "TAP," "MEM."



CTL 1



CTL 2



CTL 3

4. Press the WRITE button.

After the MEMORY Number indicator begins flashing rapidly, the setting is stored in memory and the unit returns to its ordinary state.

- * *To cancel the setting change and return the unit to its ordinary state, then before you press the WRITE button, operate the MEMORY/TAP or ON/OFF pedal.*

Display	Mode	Function	Foot Switch
ctl1, ON/OFF	CTL1	Switches effects on and off	FS-5L (Latch Type)
ctl2, TAP	CTL2	Tap input	FS-5U (Momentary Type)
ctl3, MEM	CTL3	Switches Memories	FS-5U (Momentary Type)

- * *This is set at the factory to “CTL 2.”*
- * *When you connect an external pedal after making this setting, the function you have set appears in the display, indicating that the function can be used.*



- When the CTL1 mode is selected and you are using the DD-20 in conjunction with an OD-20, you can turn the DD-20 on and off with the OD-20's AMP CTRL button by connecting the DD-20's CTL PEDAL jack and the OD-20's AMP CTRL jack.
- When using an external pedal to turn the effect on and off with the DD-20 set to CTL1 mode, if you try to switch the effect on or off with the DD-20's ON/OFF pedal, the external pedal's actual function will differ from the function that is indicated.
- The following parameters cannot be controlled by the external pedal when the external pedal is being used to turn the effect on and off with the DD-20 set to CTL1 mode.
 - Recording, playback, and overdubbing in Sound On Sound (p. 21)
 - TWIST (p. 22)
 - WARP (p. 22)
 - TAPE playback head setting (p. 23)
 - DUAL short delay time setting (p. 24)
 - MODULATE modulation rate setting (p. 25)

Changing How Memory Numbers Are Indicated

Not only can you confirm the currently selected memory merely by checking the lit MEMORY number indicators, you can also change the pattern in which the indicators light up. Select the pattern that provides the easiest way to check the memory in any particular environment.



When using the DD-20 in dimly lit surroundings, you can confirm memory numbers more easily by using the Lighting Pattern 2 setting.

Lighting Pattern 1 (Normal):

Only the indicator for the selected memory lights up (or flashes).



Lighting Pattern 2:

The number of indicators lighting up (or flashing) corresponds to the selected memory number.



1. Switch off the power.
2. While holding down the WRITE button and the SELECT button, switch on the power.
3. Press the SELECT button to set the MEMORY indicator lighting pattern.

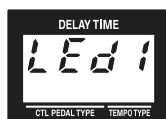

Lighting Pattern 1



Lighting Pattern 2

4. Press the WRITE button.

After the MEMORY Number indicator begins flashing rapidly, the setting is stored in memory and the unit returns to its ordinary state.

* To cancel the setting change and the unit returns to its ordinary state, then before you press the WRITE button, operate the MANUAL/TAP or ON/OFF pedal.

Returning Settings to Their Factory Defaults

You can restore the following settings to their original factory values.

Memory Settings	Memory 1 (p. 12)	SMOOTH
	Memory 2 (p. 12)	TAPE
	Memory 3 (p. 12)	DUAL
	Memory 4 (p. 12)	MODULATE
MANUAL Delay Time (p. 9) (when the power is switched on)		MANUAL: 300 msec
DUAL Short Delay Time (p. 24)		S: 50
MODULATE Rate/Depth (p. 25)		r: 80, d: 70
TAPE (p. 23)		HEd1
Pedal Mode (p. 29)		Mode 1
Output Mode (p. 30)		Mode 1
External Pedal Function (p. 31)		TAP
MEMORY Number Indication (p. 33)		Lighting Pattern 1

NOTE Carrying out the following procedure completely clears the content currently stored in the memories (1-4).

1. **Switch off the power.**
2. **While holding down the WRITE button, switch on the power.**

The MEMORY Number indicators (1-4) flash.



3. **Press the WRITE button.**

After the MEMORY Number indicators (1-4) begin flashing rapidly, the setting is stored in memory and the unit returns to its ordinary state.

* *To cancel the setting change and the unit returns to its ordinary state, then before you press the WRITE button, operate the MEMORY/TAP or ON/OFF pedal.*

Troubleshooting

The power doesn't come on.

- **Is the guitar connected correctly to the INPUT A (MONO) jack?**
 - Check the connections again (p. 4–p. 7).
 - * *When running off batteries, the unit won't switch on unless there's something plugged into the INPUT jack. This helps conserve the batteries.*

- **Is the plug connected to the INPUT B jack?**
 - When using battery power, connect the plug to the INPUT A (MONO) jack.

- **Have the batteries run down?**
 - Replace with fresh batteries (p. 3).
- **Is the specified AC adaptor (PSA-series sold separately) connected correctly?**
 - Check the connections again (p. 4–p. 7).

There is no sound.

- **Is the other equipment connected correctly?**
 - Check the connections again (p. 4–p. 7).
- **Is the volume turned down on the connected guitar/bass amp, effects processor, or other device?**
 - Check the settings on the connected equipment (p. 4–p. 7).
- **Is the Output Mode set correctly?**
 - Set the Output Mode to match the connected equipment (p. 30).
- **Is the Output Mode set to A: DIR / B: EFX?**
 - No sound is output from the OUTPUT B jack when the ON/ OFF pedal is set to OFF. Set the Output Mode to Stereo output (out 1 or out 3) (p. 30).
- **Is the effect level (E. LEVEL knob) set to minimum?**
 - Operate the E.LEVEL knob to adjust the effect level (p. 16).

Sound is distorted.

- **Are the TONE knob positioned correctly?**
 - Sounds may become distorted with the knob at certain settings. Turn down this knob, or turn down the E.LEVEL knob to appropriate level. If in spite of these measures the sound is still distorted, lower the output level of the device connected to the INPUT jacks, or set the Output Mode to +4 dB (p. 30).

Pressing the MEMORY/TAP pedal does not call up the intended memory.

- **Is the proper Pedal mode set for your current application?**
 - The MEMORY/TAP pedal (or the MEMORY/TAP pedal when pressed simultaneously with ON/OFF pedal) functions differently according to the Pedal mode settings. Use the most appropriate setting for your particular application (p. 29).
- **Is the MEMORY/TAP pedal set to the TAP function?**
 - If the MEMORY/TAP pedal is set to TAP (MEMORY/TAP pedal has been pressed for two seconds), the pedal functions as a Tap Input pedal. To switch memories, either change the pedal to the MEMORY switching function by holding down the MEMORY/TAP pedal for two seconds, or use an external pedal (p. 14–p. 15).

The volume level of the instrument connected to INPUT jack is too low.

- **Could you be using a connection cable that contains a resistor?**
 - Use a connection cable that does not contain a resistor.

Pressing the ON/OFF pedal does not switch on or off as intended.

- **Is the Pedal mode set to SOS, WARP or TWIST?**

→ The pedal functions differently according to the Pedal mode settings. For more details, refer to the description of each mode.

SOS (p. 21), WARP (p. 22), TWIST (p. 22)

Cannot be saved to the memories

- **The delay time cannot be saved in SOS or MANUAL.**

→ SOS cannot be saved to the memories.

Delay time settings in MANUAL are saved by pressing the DELAY TIME knob or switching memories before the power is turned off.

Information not displayed

- **External pedal not indicated.**

→ The external pedal is not indicated unless it is connected (p. 31).

- **Output mode not indicated.**

→ A: DIR/B: EFX is not indicated when input is in stereo.

For more detailed information, refer to “Setting the Output Mode” (p. 30).

- **The set delay time is different than the time displayed.**

→ Manual delay time settings change unless the Write procedure is carried out. The settings are saved when you press the DELAY TIME knob or switch memories.

- **The delay time does not reach the maximum of 23 seconds**

→ The range of the delay time setting may vary according to the mode and the tempo setting. For more detailed information, refer to “MODE List” (p. 18) and “How to Use the Tempo Function” (p. 26).

Sample Settings

SMOOTH (Memory 1)

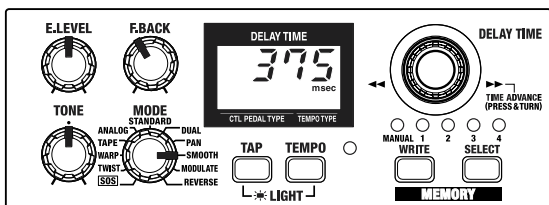

Roland SPACE ECHO RE-201 (Memory 2)

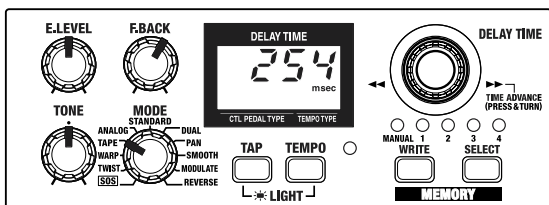

MODE: TAPE HEAD2

DUAL (Memory 3)

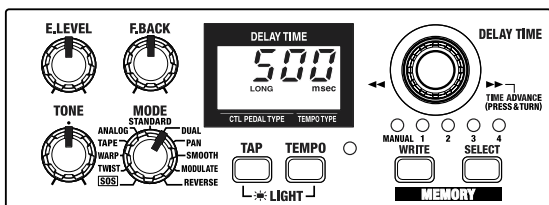

MODE: DUAL/SHORT 50 msec

MODULATE (Memory 4)

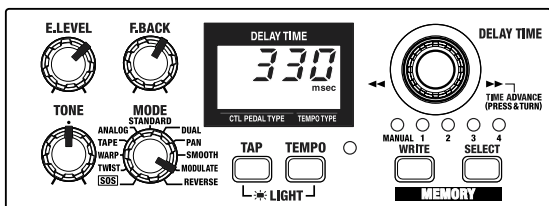

MODE: MODULATE/RATE 80, DEPTH 70

TWIST

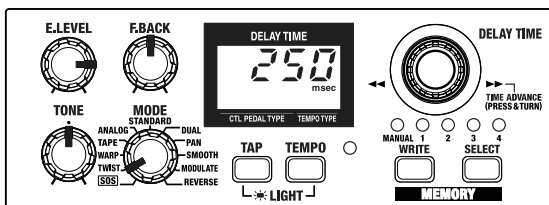

Holding down the ON/OFF pedal produces the twist effect.

REVERSE

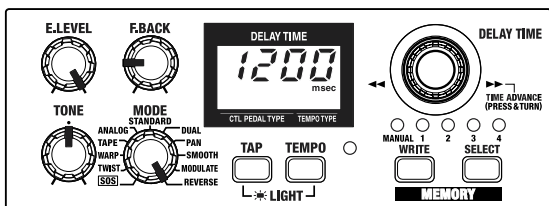

ROOM AMBIENCE

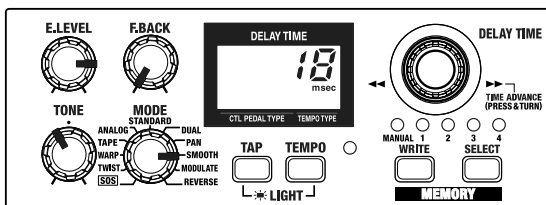

SLAP BACK ECHO

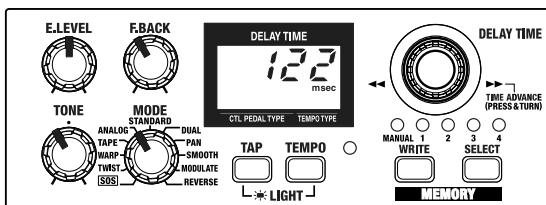

MODULATE DOUBLING

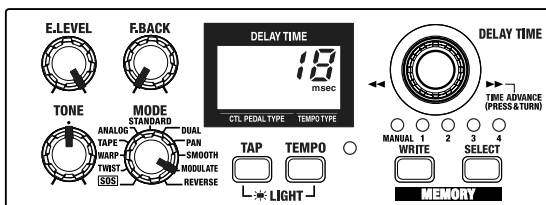

MODE: MODULATE/RATE 25, DEPTH 95

Setting Memo

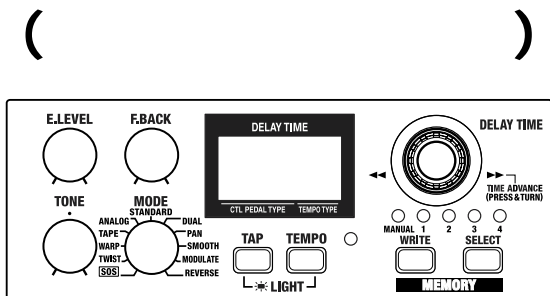
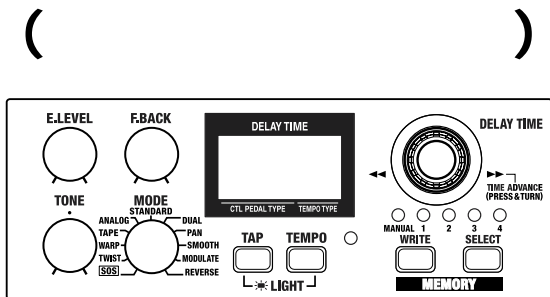
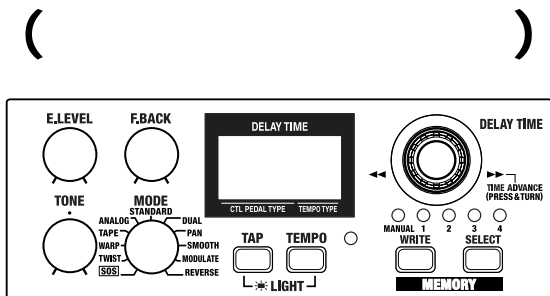

Specifications

DD-20: DIGITAL DELAY

Nominal Input Level

-20 dBu (GUITAR/BASS)

+4 dBu (AMPLIFIER SEND/RETURN)

Input Impedance

1 M Ω

Nominal Output Level

-20 dBu (GUITAR/BASS)

+4 dBu (AMPLIFIER SEND/RETURN)

Output Impedance

1 k Ω (OUTPUT A (MONO), B)

33 Ω (PHONES)

Recommended Load Impedance

10 k Ω

Residual Noise Level

-93 dBu or less (IHF-A typ.)

- * E. LEVEL/F. BACK/TONE knobs are set to the center position

Display

Custom LCD (with backlit)

Controls

ON/OFF Pedal

MEMORY/TAP Pedal

DELAY TIME Knob

E.LEVEL Knob

F. BACK Knob

TONE Knob

MODE Knob

TAP Button

TEMPO Button

MEMORY WRITE Button

MEMORY SELECT Button

Indicators

POWER Indicator

(serves also as battery check indicator)

ON/OFF Indicator

MEMORY Indicator

TAP Indicator

MANUAL Indicator

MEMORY Number Indicator 1-4

TEMPO Indicator

Connectors

INPUT A (MONO) Jack (1/4 inch phone type)

INPUT B Jack (1/4 inch phone type)

PHONES Jack (stereo 1/4 inch phone type)

CTL PEDAL Jack (1/4 inch phone type)

OUTPUT A (MONO) Jack (1/4 inch phone type)

OUTPUT B Jack (1/4 inch phone type)

AC Adaptor Jack

Power Supply

Dry battery (R6/LR6 (AA) type) x 6: DC 9V

AC Adaptor (DC 9V)

Current Draw

200 mA (9 V max.)

- * *Expected battery life under continuous use:*
Carbon: 2 hours
Alkaline: 7 hours
These figures will vary depending on the actual conditions of use.

Dimensions

173 (W) x 158 (D) x 57 (H) mm

6-13/16 (W) x 6-1/4 (D) x 2-1/4 (H) inches

Weight

1.2 kg / 2 lbs 11 oz (including batteries)

Accessories

Owner's Manual

Leaflet ("USING THE UNIT SAFELY,"

"IMPORTANT NOTES," and "Information")

Dry battery (LR6 (AA) type) x 6

- * *We recommend that alkaline batteries be used when replacing the batteries.*

Options

AC Adaptor (PSA-series)

- * *0 dBu = 0.775 Vrms*
- * *In the interest of product improvement, the specifications and/or appearance of this unit are subject to change without prior notice.*

Index

- A**
ANALOG 18
- B**
Batteries 3
BPM 27
- C**
Connection 4
CTL PEDAL 31
- D**
Delay time 17
DELAY TIME knob 17
Depth 25
Direct Sound 30
DUAL 18, 24
- E**
Effect Sound 30
External Pedal 31
- F**
Factory Defaults 34
- L**
Long delay 24
- M**
MANUAL 9–10
MEMORY 10, 12, 33
MEMORY/TAP Pedal 14
MODE 18, 21
MODULATE 18, 25
- O**
ON/OFF Pedal 8
Output Mode 30
Overdub 18, 21
- P**
PAN 18
Pedal Mode 29
Pedal mode 14
Polarity switch 31
- R**
Rate 25
REVERSE 18
- S**
Seamless switching 1
Short delay 24
SMOOTH 18
SOS 18, 21
Sound On Sound 18, 21
STANDARD 18
- T**
Tap Input 15
TAPE 18, 23
Tempo Function 26
Time Advance Function 17
TWIST 18, 22
- W**
WARP 18, 22
Write 10



This product complies with the requirements of European Directive 89/336/EEC.

For EU Countries

FEDERAL COMMUNICATIONS COMMISSION RADIO FREQUENCY INTERFERENCE STATEMENT

This equipment has been tested and found to comply with the limits for a Class B digital device, pursuant to Part 15 of the FCC Rules. These limits are designed to provide reasonable protection against harmful interference in a residential installation. This equipment generates, uses, and can radiate radio frequency energy and, if not installed and used in accordance with the instructions, may cause harmful interference to radio communications. However, there is no guarantee that interference will not occur in a particular installation. If this equipment does cause harmful interference to radio or television reception, which can be determined by turning the equipment off and on, the user is encouraged to try to correct the interference by one or more of the following measures:

- Reorient or relocate the receiving antenna.
- Increase the separation between the equipment and receiver.
- Connect the equipment into an outlet on a circuit different from that to which the receiver is connected.
- Consult the dealer or an experienced radio/TV technician for help.

This device complies with Part 15 of the FCC Rules. Operation is subject to the following two conditions:

- (1) This device may not cause harmful interference, and
- (2) This device must accept any interference received, including interference that may cause undesired operation.

Unauthorized changes or modification to this system can void the users authority to operate this equipment.
This equipment requires shielded interface cables in order to meet FCC class B Limit.

For the USA

For Canada

NOTICE

This Class B digital apparatus meets all requirements of the Canadian Interference-Causing Equipment Regulations.

AVIS

Cet appareil numérique de la classe B respecte toutes les exigences du Règlement sur le matériel brouilleur du Canada.

